

MAINTENANCE AND OPERATION  
INSTRUCTION MANUAL

# DB9000-TX

Professional IP Audio Encoder



# Contents

<b>Introduction</b> .....	<b>5</b>
<b>Typographic conventions</b> .....	<b>6</b>
<b>General Information</b> .....	<b>7</b>
<i>Application</i> .....	7
<i>Product Features</i> .....	8
<i>Technical Specifications</i> .....	9
<i>Block Diagram</i> .....	11
<b>Safety Warning</b> .....	<b>12</b>
<b>Operating Recommendations</b> .....	<b>13</b>
<b>Unpacking and inspection</b> .....	<b>14</b>
<b>Mounting</b> .....	<b>14</b>
<i>Rack Requirements 1U</i> .....	14
<i>Rack Requirements Compact Units</i> .....	14
<i>Stand-Alone Devices</i> .....	14
<b>AC Mains Power</b> .....	<b>15</b>
<i>Fuse holder</i> .....	15
<i>Mains Voltage Selector</i> .....	15
<i>Power cord</i> .....	15
<i>Ground Loops</i> .....	15
<i>Mains Voltage Selector Location</i> .....	16
<b>Getting Started</b> .....	<b>17</b>
<i>Connection</i> .....	17
<i>Network Settings</i> .....	18
<i>Network Discovery</i> .....	18
<i>Network Security Recommendations</i> .....	19
<b>Panel Indicators and Appointments</b> .....	<b>20</b>
<i>Front View</i> .....	20
<i>Rear View</i> .....	21
<b>Connecting of DB9000-TX</b> .....	<b>22</b>
<i>Analog Audio Inputs</i> .....	22
<i>Digital Audio Input</i> .....	22
<i>LAN Port</i> .....	22
<i>RS-232 COM Port</i> .....	22
<b>Operation</b> .....	<b>23</b>
<i>Network Discovery</i> .....	23
<i>Access</i> .....	23
<i>WEB Interface</i> .....	23
<i>Status</i> .....	25
<i>DB9000-TX Configuration</i> .....	27
<i>Network Settings</i> .....	27
<i>WEB Server Settings</i> .....	28
<i>SNMP Settings</i> .....	28
<i>Audio Settings</i> .....	29
<i>Codec Settings</i> .....	29
<i>Stream Server Settings</i> .....	30

<i>RTP Settings</i> .....	30
<i>Icecast Settings</i> .....	30
<i>RS-232 Settings</i> .....	31
<i>Applying New Settings</i> .....	31
<b>Factory Default Settings</b> .....	32
<i>Audio Default Settings</i> .....	33
<i>Network Default Settings</i> .....	33
<i>WEB Server Default Settings</i> .....	33
<i>SNMP Default Settings</i> .....	33
<i>Stream Server Default Settings</i> .....	33
<i>RS-232 Default Settings</i> .....	33
<i>RTP Settings</i> .....	33
<i>Icecast Settings</i> .....	33
<b>Hardware Reset</b> .....	34
<i>Network Default Settings</i> .....	34
<i>WEB Server Default Settings</i> .....	34
<b>Rebooting</b> .....	35
<b>Firmware Update</b> .....	36
<i>Connecting to the Stream Server</i> .....	37
<b>UPnP discovery in Local Networks</b> .....	38
<b>UPnP Activation</b> .....	39
<b>WARRANTY TERMS AND CONDITIONS</b> .....	40
<b>Product Registration Card</b> .....	41

THIS PAGE  
IS INTENTIONALLY  
LEFT BLANK

## Introduction

DEVA Broadcast Ltd. is an international communications and high-technology manufacturing organization, its corporate headquarters and facility located in Burgas, Bulgaria. The company serves the broadcast and corporate markets worldwide – from consumers and small businesses to the largest global organizations. It is dedicated to the research, design, development and provision of advanced products, systems and services. DEVA Broadcast launched its own brand back in 1997 and has nowadays evolved to become known as a market leader and internationally reputed manufacturer of user-friendly, cost-effective and innovative broadcast products.

Creativity and innovation are deeply woven into DEVA Broadcast corporate culture. Through successful engineering, marketing and management our team of dedicated professionals creates future-oriented solutions to improve customers' performance. You may rely that all issues communicated to our crew would be addressed accordingly. We pride ourselves on our pre and post-sales support and purchase services, which along with the outstanding quality of our radio gear have won us due respect and the market authority position.

DEVA Broadcast best-of-breed solutions have become the best sellers for our partners. The strategic partnerships which have been formed with industry leaders during all these years that we have been operating on the broadcasting market, have proved us a reliable business partner and a valuable asset, as our dealers worldwide would confirm. In constant pursuit of precision and long-term satisfaction, DEVA Broadcast enhances the reputation of our partners and clients alike. Furthermore, we have already a proven merit as a credible partner provider.

Our portfolio offers complete line of high quality and competitive products for FM and Digital Radio, Radio Networks, Telecommunication Operators and regulation authorities. For almost two decades of intensive software and hardware development, we have achieved a unique price-performance and endurance of our product lines. Our company's multitude of equipment and services is in line with the latest technologies and key trends. The most recognizable characteristics attributed to DEVA Broadcast products are their clear-cut, streamlined design, easiness of use and cost-effectiveness: simplicity of forms but multiplicity of functions.

For us there is no stage when we deem that we have reached the most satisfactory level in our work. Our engineers are in constant pursuit of new ideas and technologies to be captured in DEVA Broadcast solutions. Simultaneously, a strict control is being exercised at each step of any new development. Experience and hard work are our fundament but the continuous improving process is what we never leave aside. DEVA Broadcast participates on a regular basis in all landmark broadcasting events, not only to promote its products, but to exchange valuable know-how and experience. We are also engaged in international large-scale projects involving radio and audio solutions which makes us even more competitive on the global market.

All DEVA Broadcast products are developed and produced in accordance with the latest ISO 9001 quality control standards.

## Typographic conventions

The following table describes important conventions used in the manual.

Convention and Style	Description	Examples
<i>Menu &gt; Sub Menu &gt; Menu Command</i>	A menu item(s) and menu command that you need to click in sequence	Click <i>Settings &gt; General</i>
[Button]	Interface Interactive buttons	Press [OK] to save the changes
<b>NOTE</b>	Important notes and recommendations	<b>NOTE:</b> The notification will appear only once
<u>“Reference Name” on Page XXX</u>	References and links	refer to <u>“New Connection”</u> (see <u>“Monitoring” on page 56</u> )
Example	Used when example text is cited	Example for E-mail Notification: Date: 04 Nov 2013, 07:31:11

## General Information

DB9000-TX is a multi protocol Audio over IP encoder, specially designed to serve DEVA's most demanding clients.

Encoding the analog audio sources into high quality configurable format happens in real time by HE-AAC Versions 1 and 2 or MPEG-1 Layer 3. DB9000-TX supports PCM uncompressed audio, guarantees audio transmission without quality loss.

Operating with either analog or digital audio signal, the device compresses the output signal, directly transmitted over IP-based networks to one or more (up to 10) decoders such as DB9000-RX, DB90-RX or other compatible IP audio players.

Once an audio source is selected, the encoded in real time audio is immediately sent to the network. DB9000-TX can act simultaneously as an Icecast compatible Server, Icecast source client or Real Time Protocol (RTP) sender. The audio stream can be spread over an IP-based network to one or more (up to 10) DB90-RX or other compatible IP audio decoders. Using the RS-232 port, DB9000-TX could be easily transformed from an Ethernet to a serial Redirector, enabling management of third party RS-232 managed equipment.

Highly valued by the professional broadcasters and situated on thousands of locations all over the world, DB90-TX allows management by any kind of web browser from your PC, PDA or any kind of mobile device. That is what makes it the best choice for professional and consumer use.

## APPLICATION

---

- Audio broadcasting over IP-based networks.
- Point-to-Point Audio Transfer (DB9000-RX is required at the opposite site).
- Suitable for professional and consumer use.
- Ethernet to RS-232 Redirector

## PRODUCT FEATURES

---

- High Quality HE-AAC (v.1 and v.2) and MPEG-1 Layer 3 Codecs
- 32 kHz, 44.1 and 48 kHz sample rates support
- Up to 56 kbps under HE-AAC
- Up to 320 kbps under MPEG-1 Layer 3
- Shoutcast / Icecast compatible TCP/IP stream
- Up to 10 simultaneously connected clients \*
- 4 LEDs and Phones output for quick diagnostics
- IP address pronunciation at startup (through the headphones)
- Full Control and easy setup via a standard web browser
- UPnP for easy discovery in Local Networks
- Ethernet to RS-232 Redirector

\* Actual limit depends on the speed of the link and/or other factors.

## TECHNICAL SPECIFICATIONS

<b>AUDIO CODEC</b>	
Codec	HE-AAC (v.1 and v.2),; MPEG-1 Layer 3; raw PCM
Sample rates	32 kHz 44.1 kHz 48 kHz
Channels	1 or 2
Bitrates	Up to 56 kbps (HE-AAC); Up to 320 kbps (MPEG-1); Up to 1536 kbps (PCM);
<b>MPEG-1 LAYER 3 SPECIFIC</b>	
Encoding mode	Mono and stereo, Joint Stereo or Dual Channel
Emphasis	50µs, CCITT J.17 or none
<b>PCM CODEC</b>	
Channels	1 or 2
Bitrate	Up to 3072 kbps
<b>ANALOG AUDIO INPUT</b>	
Connector	2 x XLR, stereo
Type	Balanced
Impedance	600Ω or high impedance
Level	+6dBu / +12dBu, user selectable
Sample rate	96 kHz; Build-in sample rate converter used to produce lower sample rates
Dynamic range	>100 dB
<b>DIGITAL AUDIO INPUT</b>	
Connector	XLR
Type	AES/EBU (IEC 60958)
Resampling	Thru build-in sample rate converter
<b>STREAMING SERVER</b>	
Type	Shoutcast / Icecast compatible TCP/IP stream
Codec	AAC, MP3, PCM
Clients limit	Up to 10 simultaneous clients
<b>ICECAST SOURCE CLIENT</b>	
Type	Icecast Source Client
Codec	AAC, MP3, PCM
Count	1

<b>RTP SENDER</b>	
Type	Unicast RTP Sender
Codec	AAC, MP3
Count	1
<b>PHONES AUDIO OUTPUT</b>	
Connector	6.3mm jack, stereo
Type	Headphones
<b>USER INTERFACE</b>	
Indicators	4 LEDs on front panel, 2 LEDs on rear panel
Web interface	Full control and status information
<b>RS-232</b>	
Type	TCP/IP to RS-232 Redirector
Connector	DB-9
Baud rates	9600 to 115200
Password protection	Yes
<b>NETWORK</b>	
Connector	RJ-45
Type	Ethernet
Device discovery	UPnP support
<b>OPERATING CONDITIONS</b>	
Temperature	-15°C to 55°C
Humidity	< 95%, non-condensing
Altitude	0 to 5000m above sea level
<b>POWER REQUIREMENTS</b>	
Power supply	115/230V AC (internal switch), 18VA
Connector	IEC320, rear panel
<b>SIZE AND WEIGHT</b>	
Dimension (W x H x D)	1U, 19" x 1.7" x 6.9", 485 x 44 x 178mm
Weight	8 lbs, 3.5 kg

## BLOCK DIAGRAM

---

A simplified block diagram of DB9000-TX is shown below

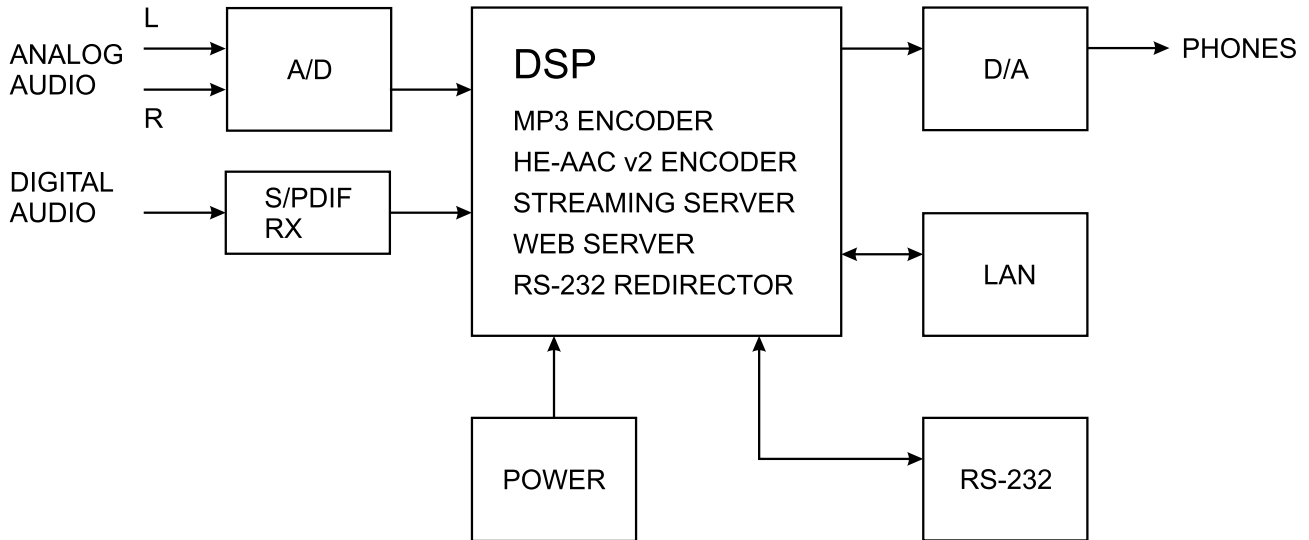

Because of the all-digital, minimalist-discrete-component nature of device circuitry, we have not provided schematic diagrams of the DB9000-TX in this Manual. Please, note that:

**NO USER-SERVICEABLE COMPONENTS INSIDE.  
REFER ALL SERVICING TO  
QUALIFIED TECHNICAL PERSONNEL.**

## Safety Warning

### **ALWAYS OBSERVE THE SAFETY PRECAUTIONS.**

Careful observance of the safety precautions will help prevent physical injury, damage of the equipment, and extend the equipment life.

- The servicing of electronic equipment should be performed only by qualified personnel;
- Before removing the covers the unit must be switched off and the mains cable unplugged;
- When the equipment is open, the power supply capacitors should be discharged using a suitable resistor;
- Never touch the wires or the electrical circuits;
- Use insulated tools only;
- Never touch the metal semiconductor. They might carry high voltages;
- For removing and installing electronic components, follow the recommendations for handling MOS components.
- Do not remove the factory sticker from the equipment. It contains information as regards the name, serial number and MAC address of the device.
- To join the equipment to the mains supply, use the power cord purchased with the equipment.

## Operating Recommendations

To ensure normal operation of the DEVA unit, we recommend following the instructions listed below.

- Install the unit in places with good air conditioning. The unit is designed to operate within the ambient temperature range of 10 to 50°C. The equipment rack should be ventilated in order for the device to keep its internal temperature below the maximum ambient temperatures;
- We do not recommend installation in rooms with high humidity, dusty places or other aggressive conditions;
- Although the device is intended to be installed closed to exciters or transmitters, we do recommend the device to be located away from abnormally high RF fields.
- Use only checked power supply cables. We strongly recommend the usage of shielded cables;
- Connect the DEVA unit to reliable power supply sources only. In case of unstable power supply, please use Uninterruptible Power Supply (UPS);
- Use the device only with its top cover on to avoid electromagnetic anomalies. Otherwise, this may cause problems with the normal functionality of the unit;
- To ensure normal remote operation of the unit, make sure to connect the device to a good quality Internet connection;
- For the normal operation of your DEVA device, check if the network settings past through all the required data traffic.

## Unpacking and inspection

Upon receipt, the equipment should be inspected for possible shipping damages. If such are found or suspected, notify the carrier at once and contact DEVA Broadcast Ltd. The original shipping carton box and packing materials should be kept for possible reuse, in case of return for Warranty repair, for example. Shipping damages as a result of improper packing for return may invalidate the Warranty!

**The packing material (plastic bags, polystyrene, nails, etc.) must never be left within reach of children, as these items are potential sources of danger.**

**IT IS VERY IMPORTANT** that the [“Product Registration Card”](#) included in the Manual be completed accurately and returned. This will assure coverage of the terms of the Warranty and it will provide a means of trace in case of lost or stolen equipment. In addition, the user will automatically receive SERVICE OR MODIFICATION INSTRUCTIONS from DEVA Broadcast Ltd.

## Mounting

### **RACK REQUIREMENTS 1U**

---

The unit mounts in a standard 19-inch equipment rack and requires only 1 $\frac{3}{4}$  inches (1U) of vertical rack space. In order the painted finish around the mounting holes to be protected, the use of plastic washers is recommended.

### **RACK REQUIREMENTS COMPACT UNITS**

---

Our customized 1U 19-inch rack accessory provides a professional mounting option for up to three compact size DEVA units. It is made of milled aluminum and finished in black powder coat. Two extra blanking panels and set of mounting screws are provided with each rack bracket kit.

### **STAND-ALONE DEVICES**

---

DEVA's stand-alone units (Radio Explorer series, BandScanner series, DVB Explorer) do not require additional tools or installation brackets.

## AC Mains Power

### FUSE HOLDER

---

The fuse holder is placed inside the unit, next to the voltage selector. Apply downward pressure and pull the cap outward to access the 5mm mains fuse. The reverse process will release the cap.

### MAINS VOLTAGE SELECTOR

---

Before connecting the AC Power, make sure that the internal Power Switch is in accordance with the mains supply at your location. The Power Supply Factory Settings are:

- 100 - 240 VAC
- 1 Amp Fuse

**CAUTION:** Permanent damage will result if improper AC supply voltage is applied to the device. The warranty DOES NOT cover damages caused by applying improper supply voltage or usage of improper fuse.

### POWER CORD

---

The detachable IEC-type power cord is supplied with the unit. The individual cord conductors may be color-coded in either of two ways:

- 1) In accordance with US standards:  
BLACK = AC "HOT"  
WHITE = AC NEUTRAL  
GREEN = EARTH GROUND

- 2) To European CEE standards:  
BROWN = AC "HOT"  
BLUE = AC NEUTRAL  
GREEN/YELLOW = EARTH GROUND

### GROUND LOOPS

---

Because the unbalanced INPUTS/OUTPUTS of the device are chassis-ground-referenced, a mains frequency or INPUT/OUTPUT ground loop could be formed between the input or output cable shield grounds and the AC power cord ground. A 'ground-lifting' AC adapter may help in this situation, although the chassis must be properly grounded for safety purposes. In general, the equipment being installed in a rack will satisfy the safety requirement.

## MAINS VOLTAGE SELECTOR LOCATION

Unless specifically ordered for export shipment, the DB9000-TX is set at the factory for operation from 115V/230V, 50/60Hz AC mains. This can be confirmed by checking the voltage selector inside the unit. To change the mains voltage, first remove the top cover of the unit. A clearly marked slide switch is next to the AC mains connector on the encoder circuit board. *With power disconnected*, use a small screwdriver to set the switch for 115VAC or 230VAC operation. Be sure to install the appropriate fuse, DB9000-TX is equipped at the factory with 1A fuse.

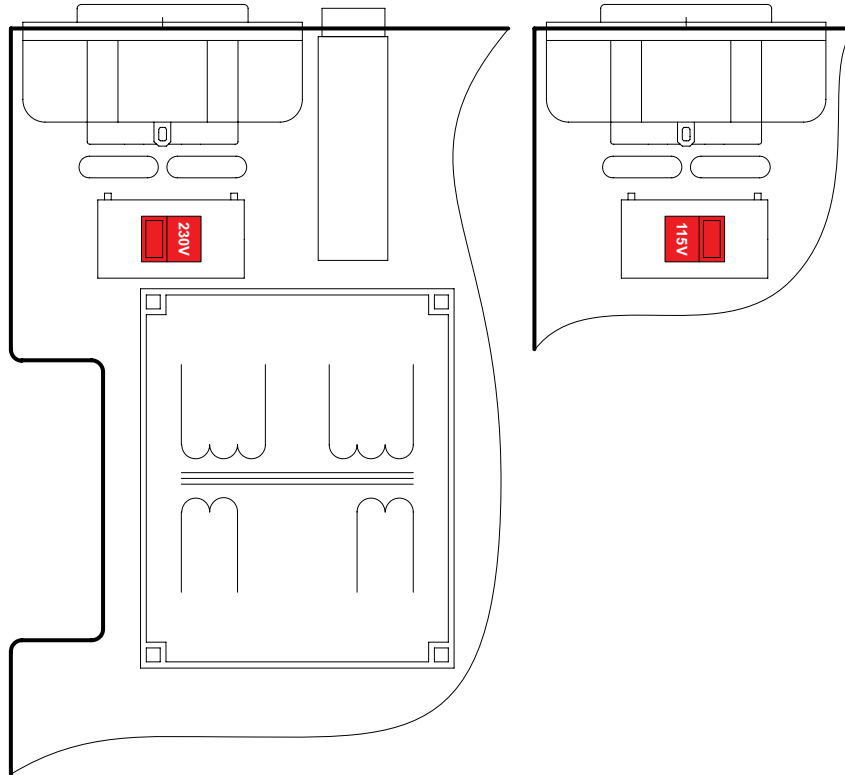

## Getting Started

In order for the normal operation of the DB9000-TX to be guaranteed, you will need fulfill the following conditions:

1. Standard Ethernet 10/100M connection;
2. Correctly assigned Network configuration and device settings.

To make sure that all the conditions are fulfilled please, follow the instructions below.

### CONNECTION

---

1. Install the unit on its operation place;
2. Using the provided power cable, connect the unit to the power supply network;
3. Connect the antenna cable to the RF antenna input connector located on the rear panel of the device;
4. Connect the DB9000-TX to the TCP/IP network using direct network cable;
5. **IF GSM OPTION IS SUPPORTED** - Using the connection cable provided, connect the optional GSM modem. In order for better GSM network coverage to be achieved, please select proper place for the GSM antenna.

**NOTE:** The GSM antenna must be installed far enough from the monitoring devices. The GSM modem radiates RF signal that may cause spurious emissions that will may interfere with the accuracy of the measurements.

## NETWORK SETTINGS

---

After connecting the network cable the Led ‘LAN’ located on the rear panel must be ON or flashing. The next and most important step for configuration is the adjustment procedure of the Network Communication. The settings shown below are Default Network Settings:

DHCP	Enabled
IP	Assigned by DHCP
Mask	Assigned by DHCP
Gateway	Assigned by DHCP
DNS	Assigned by DHCP
HTTP Port	80

## NETWORK DISCOVERY

---

This is a network setting that defines whether your computer can see (find) other computers and devices on the network and whether other computers on the network can see your computer. By default, Windows Firewall blocks network discovery but you can enable it.

1. Open Advanced sharing settings by clicking the Start button, and then on “Control Panel”. In the search box, type “network”, click “Network and Sharing Center”, and then, in the left pane click “Change advanced sharing settings”;
2. Select your current network profile;
3. Click “Turn on network discovery”, and then click save changes.

**NOTE:** If you’re prompted for an administrator password or confirmation, type the password, provide confirmation or contact your system administrator.

If you have already enabled this function on your computer DB9000-TX will be automatically added to the Device list section. The device will be ready for usage and no additional adjustments will be required except user name and password.

**NOTE:** If the port is different than the default one (80), it is necessary to specify it, for example:  
`http://192.168.1.2:9000`

**ATTENTION:** Depending on Internet Protocol Settings, the assigned IP address may not be visible outside your local network, thus the device may be accessed only within that network. Consult with your network administrator for the appropriate IP settings.

## **NETWORK SECURITY RECOMMENDATIONS**

---

1. It is not recommended the DB9000-TX to be directly connected to the Internet. This may lead to unregulated access and/or problematic operation of the device. To ensure secure connection, we recommend the device to be installed behind a router with an active firewall.
2. If remote access to the device is needed, we recommend using VPN to the router or the port of the relevant service (WEB, SNMP, Application, etc.) to be properly NAT forwarded.
3. If NAT forward is used, it is highly recommended random ports of your choice to be used. Not the standard ones (80 for WEB, 161 for SNMP, etc.).
4. Using DMZ connection is not recommended.
5. Make sure to change the standard access credentials (usernames and passwords, SNMP communities).

For detailed information as regards the recommendations listed above or need of further instructions, please contact your network administrator.

## Panel Indicators and Appointments

### FRONT VIEW



- 1 - Phones Output. The following audio signals are reproduced through the headphones:
  - Voice Announcement of DB9000-TX IP address upon startup;
  - Audio signal from the selected input;
- 2 - Power LED Indicator.
- 3 - Connection LED Indicator. This LED can be in one of the following states:
  - Off - NO clients are connected to the encoder;
  - Blinking slow – at least one client is connected to the streamer;
  - Blinking fast – maximum allowable clients are connected to the streamer ([see “Stream Server Settings” on page 30](#));
- 4 - Left Channel Level LED Indicator. This LED can be in one of the following states:
  - Off - the channel level is within norms;
  - Blinking – indication of low signal level;
  - Constantly lit – indication of high signal level;
- 5 - Right Channel Level LED Indicator. This LED can be in one of the following states:
  - Off - the channel level is within norms;
  - Blinking – indication of low signal level;
  - Constantly lit – indication of high signal level;

## REAR VIEW

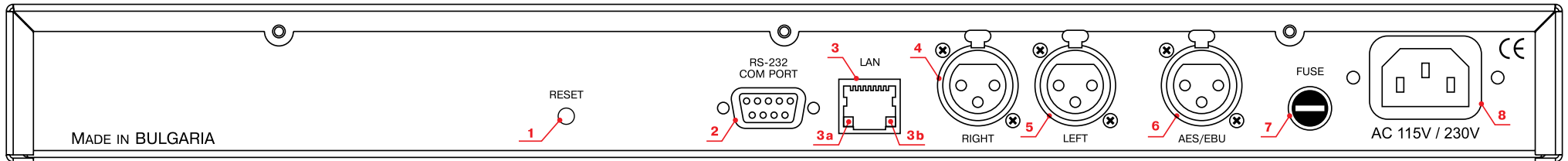

- 1 - Factory Defaults Reset Button
- 2 - RS-232 Serial COM Port - DB-9 Female Connector;
- 3 - LAN Port / Internet Input – RJ-45 Connector;
- 3a - Network Activity LED Indicator (RJ-45 built-in);
- 3b - Network Availability LED Indicator (RJ-45 built-in);
- 4 - Right - Analog Audio Input – Balanced XLR Female;
- 5 - Left - Analog Audio Input – Balanced XLR Female;
- 6 - AES/EBU - Digital Audio Input – Balanced XLR Female;
- 7 - Fuse;
- 8 - Main Power Supply;

## Connecting of DB9000-TX

### **ANALOG AUDIO INPUTS**

---

Using a cable ending with two standard XLR connectors connect the analog signal source to the analog audio inputs of DB9000-TX.

**WARNING:** Do not exceed maximum input level. This may permanently damage DB9000-TX.

### **DIGITAL AUDIO INPUT**

---

Using a cable ending with a standard XLR connectors connect the AES/EBU signal source to the digital audio input of DB9000-TX.

**NOTE:** As only one input can be managed by the encoder at a time, please select the preferred signal source input – either analog or digital one. Selecting the preferred input can be performed under CONFIGURATION menu ([see “Audio Settings” on page 29](#)).

### **LAN PORT**

---

To ensure normal operation of the DB9000-TX, its is necessary the device toto be connected to a local network or Internet by cable with RJ-45 connector.

### **RS-232 COM PORT**

---

Using standart DB-9 cable connect DB9000-TX to any RS-232 compatible equipment.

## Operation

DB9000-TX is controlled through a built-in WEB Server and a standard web browser can be used to monitor its status or to make some adjustments. To operate the device you need to know its IP Address. In case you are not aware of it, you can hear it through the headphones when you turn on the device. Alternatively, use the Network discovery feature at Local networks. Then open a new WEB Browser and enter the device IP address in the address field then press [Enter].

## NETWORK DISCOVERY

---

This is a network setting that defines whether your computer can see (find) other computers and devices on the network and whether other computers on the network can see your computer. By default, Windows Firewall blocks network discovery but you can enable it.

1. Open Advanced sharing settings by clicking the Start button, and then on “Control Panel”. In the search box, type “network”, click “Network and Sharing Center”, and then, in the left pane click “Change advanced sharing settings”;
2. Select your current network profile;
3. Click Turn on network discovery, and then click save changes.

**NOTE:** If you’re prompted for an administrator password or confirmation, type the password, provide confirmation or contact your system administrator.

If you have already enabled this function on your computer DB9000-TX will be automatically added to the Device list section. The device will be ready for usage and no additional adjustments will be required except *user name* and *password*.

## ACCESS

---

DB9000-TX provides you with a protected access to the device settings. To make the necessary adjustments to the device, please log in as an ADMINISTRATOR. The default values being username: admin, password: pass.

## WEB INTERFACE

---

The Navigational menu and its options are available at the top part of the WEB Interface. The settings window below is divided into two sections - settings (on the left) and help section with brief explanation of the settings. Pointing the mouse cursor on any of the fields in the left part of the screen will open a new window with additional and useful information.

Upon entering the WEB Interface, this is how the main page will look like.



**NOTE:** Username and Password may be requested if the Access Control is enabled and a page other than STATUS is selected (see “WEB Server Settings” on page 31). The default values are *user* and *pass*.

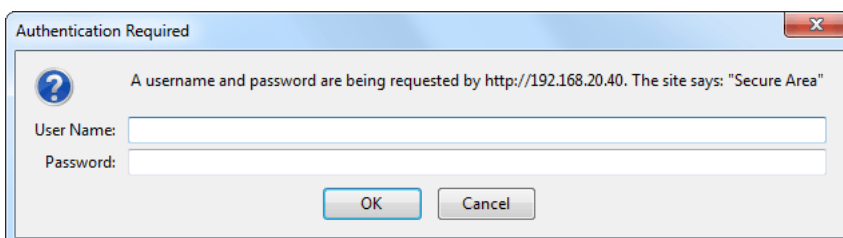

## STATUS

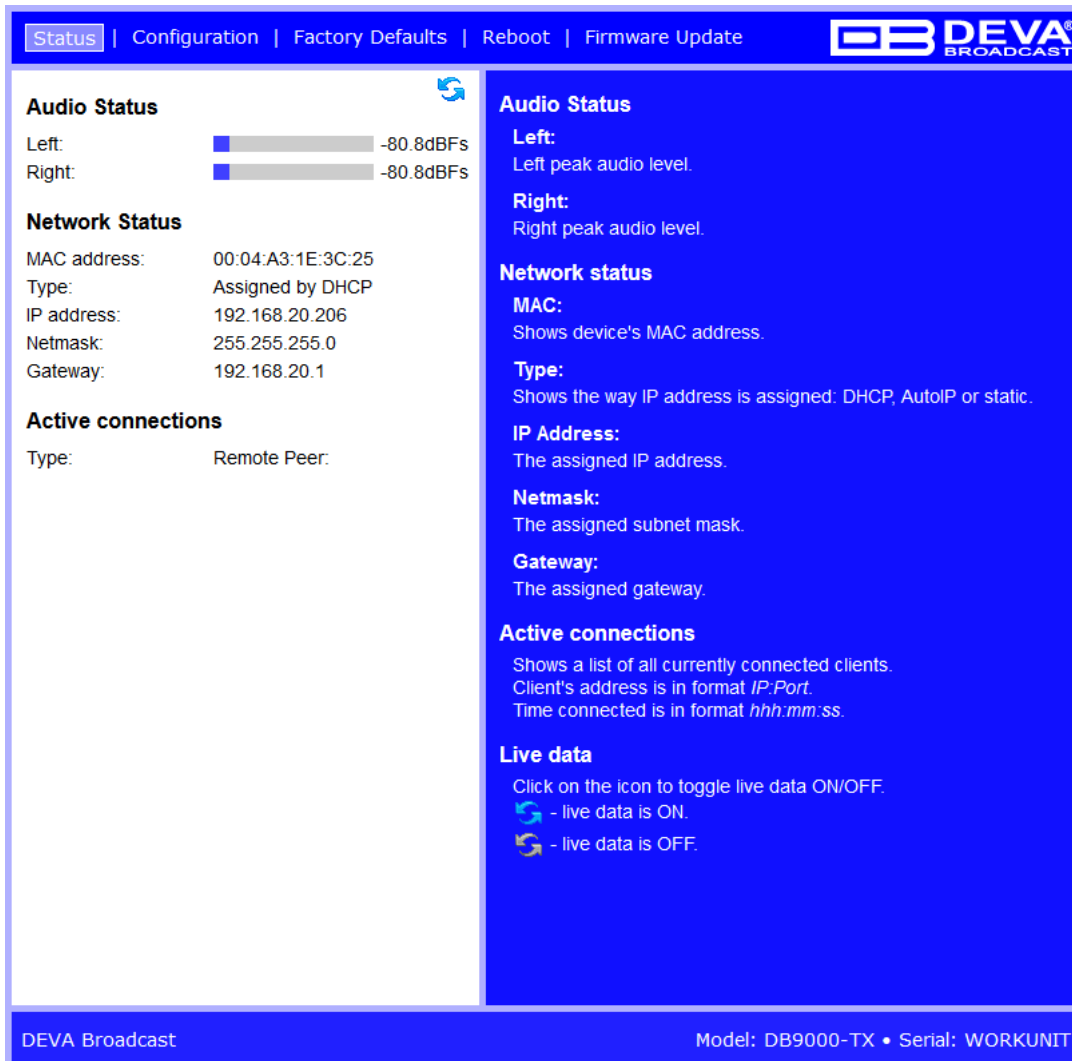

This page contains information regarding DB9000-TX current status:

- Input Signal Level;
- Network Settings;
- List of Active Connections;

Level of the input signal and the list of active connections are updated dynamically which makes it possible to remotely monitor encoder's operation.

Network Status section contains information about the MAC address and current IP address, Network mask, Gateway and the method in which they are assigned:

- Static Allocation Settings;
- Allocated by DHCP server ;
- Automatically generated;

The last option uses AutoIP to generate a unique IP address. This option is activated automatically when the device is set to use DHCP server ([see "Network Settings" on page 27](#)), but such server is not available.

The list of Active Connections provides information for the currently connected clients. Shown are the IP address and local port of each client. Link duration is visible as well.

In the upper right corner is located LIVE DATA icon. Clicking on the icon will toggle live data ON and OFF as follows:



- live data is ON



- live data is OFF.

## DB9000-TX CONFIGURATION



The screenshot shows the configuration page for the DB9000-TX device. The top navigation bar includes 'Status', 'Configuration' (selected), 'Factory Defaults', 'Reboot', and 'Firmware Update'. The 'Network' tab is active, with sub-tabs for 'IP Audio' and 'COM Port'. The interface is divided into two main sections: 'General' and 'Network settings'.

**General**

DHCP:  Enabled  Disabled

IP Address:

Netmask:

Gateway:

**WEB server**

Port:

Username:

Password:

**SNMP**

SNMP MIB File:

Agent:  Enabled  Disabled

Agent Port:

Manager Port:

Agent ID:

Community:

Manager IP:

**Network settings**

**DHCP:**  
 Enable or disable DHCP client.  
 The DHCP client is used to automatically obtain the network settings.  
 Default: Enabled

**IP Address:**  
 Static IP address. Not used if DHCP client is enabled.  
 Example: 192.168.0.2

**Netmask:**  
 Static subnet mask. Not used if DHCP client is enabled.  
 Example: 255.255.255.0

**Gateway:**  
 Static gateway. Not used if DHCP client is enabled.  
 Example: 192.168.0.1

**Web settings**

**Port:**  
 TCP port of the web server.  
 Default: 80

**Username:**  
 User name for the web server. It is used to restrict the access to all configuration pages.  
 If both Username and Password are left blank no security is used.  
 Up to 15 alpha-numeric characters.

**Password:**  
 Password for the web server. It is used to restrict the access to all configuration pages.  
 If both Username and Password are left blank no security is used.  
 Up to 15 alpha-numeric characters.

Deva Broadcast Ltd. © 2012 Model: DB9000-TX • Serial: 110307001

### Network Settings

- DHCP – as DHCP Client is used to automatically obtain the Network Settings. It can be enabled or disabled.
- IP Address – a field where static IP address is to be specified in case that DHCP client is not used. Example: 192.168.0.2.
- Netmask – a field where Static Subnet Mask is to be inserted. This parameter is not used if DHCP Client is enabled. Example for Netmask is: 255.255.255.0.
- Gateway – a field where Static Gateway is to be inserted. This parameter is not used if DHCP Client is enabled. Example for Gateway is: 192.168.0.1.

**NOTE:** If the encoder's IP address is changed, it is necessary to enter the new IP address in your browser.

## WEB Server Settings

- Port – this is the TCP port of the WEB Server. Default value is 80.
- Username – user name of the WEB Server. Default value is *user*.
- Password – Password of the WEB Server. Default value is *pass*.

**NOTE:** You can define Username only, Password only or both of them. If both Username and Password are left blank, NO security is used.

## SNMP Settings

SNMP MIB File: Press the Download button to download DB9000-TX SNMP MIB file.

**NOTE:** The MIB file may change from one firmware revision to another. Downloading this file from the device ensures that you have the latest MIB file available.

Specify Agent ID, Agent Port, Read/Write Communities, Manager IP and Manager Port.

**NOTE:** Agent ID is used to identify the device among others when a SNMP notification is send.  
Agent - enables/disables SNMP Agent.

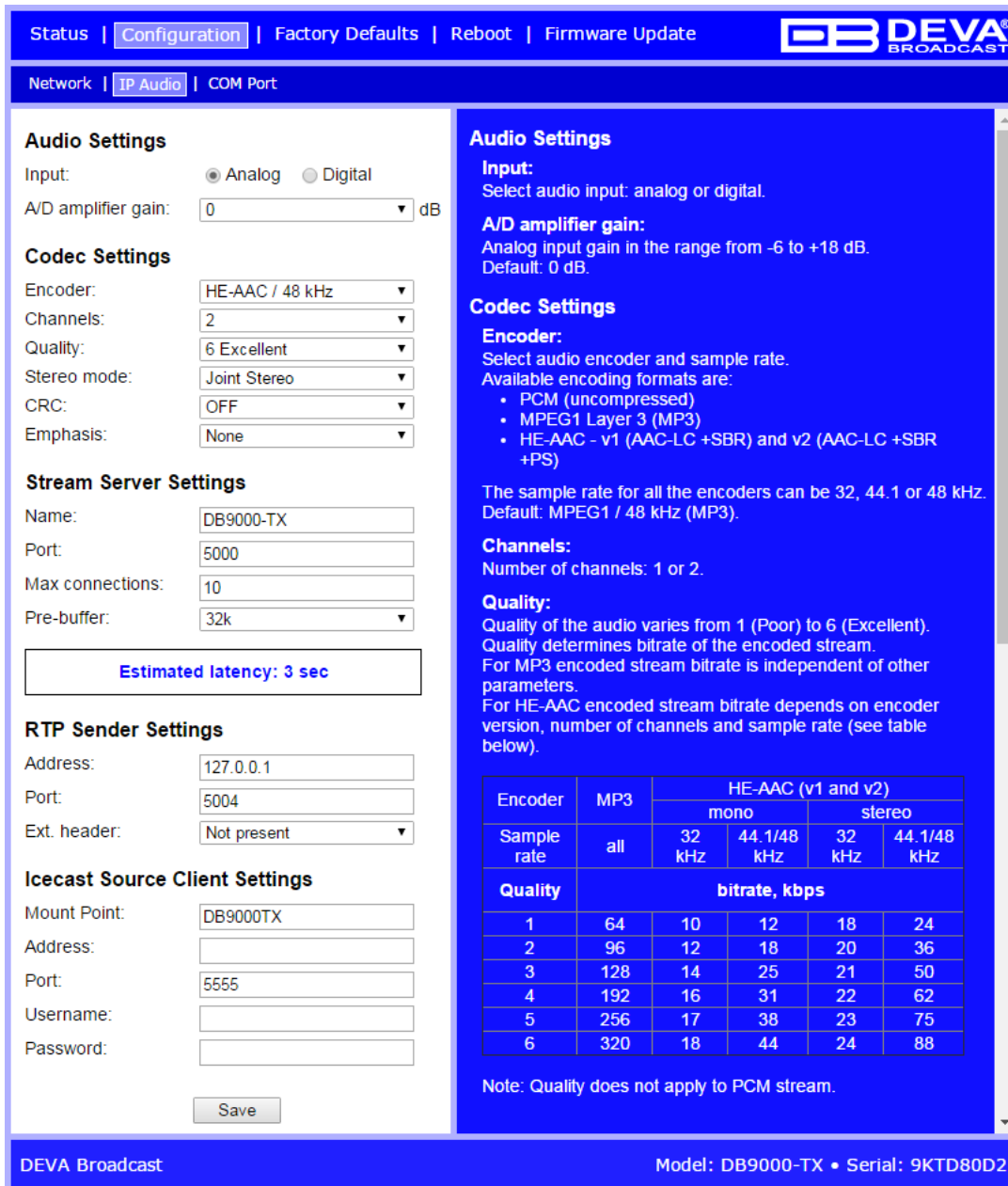

The screenshot shows the configuration page for a DEVA Broadcast device. The 'Configuration' tab is active. The interface is divided into several sections:

- Audio Settings:** Input (Analog selected), A/D amplifier gain (0 dB).
- Codec Settings:** Encoder (HE-AAC / 48 kHz), Channels (2), Quality (6 Excellent), Stereo mode (Joint Stereo), CRC (OFF), Emphasis (None).
- Stream Server Settings:** Name (DB9000-TX), Port (5000), Max connections (10), Pre-buffer (32k). A box below indicates 'Estimated latency: 3 sec'.
- RTP Sender Settings:** Address (127.0.0.1), Port (5004), Ext. header (Not present).
- Icecast Source Client Settings:** Mount Point (DB9000TX), Address, Port (5555), Username, Password.

On the right side, there is a detailed 'Audio Settings' section with explanatory text and a table:

**Audio Settings**  
**Input:** Select audio input: analog or digital.  
**A/D amplifier gain:** Analog input gain in the range from -6 to +18 dB. Default: 0 dB.  
**Codec Settings**  
**Encoder:** Select audio encoder and sample rate. Available encoding formats are:  
 • PCM (uncompressed)  
 • MPEG1 Layer 3 (MP3)  
 • HE-AAC - v1 (AAC-LC +SBR) and v2 (AAC-LC +SBR +PS)  
 The sample rate for all the encoders can be 32, 44.1 or 48 kHz. Default: MPEG1 / 48 kHz (MP3).  
**Channels:** Number of channels: 1 or 2.  
**Quality:** Quality of the audio varies from 1 (Poor) to 6 (Excellent). Quality determines bitrate of the encoded stream. For MP3 encoded stream bitrate is independent of other parameters. For HE-AAC encoded stream bitrate depends on encoder version, number of channels and sample rate (see table below).

Encoder	MP3	HE-AAC (v1 and v2)			
		mono		stereo	
Sample rate	all	32 kHz	44.1/48 kHz	32 kHz	44.1/48 kHz
Quality	bitrate, kbps				
1	64	10	12	18	24
2	96	12	18	20	36
3	128	14	25	21	50
4	192	16	31	22	62
5	256	17	38	23	75
6	320	18	44	24	88

Note: Quality does not apply to PCM stream.

DEVA Broadcast Model: DB9000-TX • Serial: 9KTD80D2

### Audio Settings

- Input – select analog or digital input to be used.
- A/D Amplifier Gain – Analog input gain in the range from -6 to +18 dB. Default level is 0dB.

### Codec Settings

- Encoder + Sample Rate – select audio encoder and sample rate. Available encoding formats are:
  - HE-AAC v1 (AAC-LC +SBR)
  - HE-AAC v2 (AAC-LC +SBR +PS)
  - MPEG1 Layer 3 (MP3)
  - PCM (uncompressed)
- Channels – select number of the input channels (1 or 2). If only one channel is selected, then the Left one is used.
- Quality – Audio quality varies from 1 (Poor) to 6 (Excellent). Quality determines bitrate of the encoded stream. For MP3 encoded stream bitrate is independent of other parameters.

For HE-AAC encoded stream bitrate depends on encoder version, number of channels and sample rate (see table below):

Encoder	MP3	HE-AAC (v1 and v2)			
		mono		stereo	
Sample rate	all	32 kHz	44.1/48 kHz	32 kHz	44.1/48 kHz
Quality	bitrate, kbps				
1	64	10	12	18	24
2	96	12	18	20	36
3	128	14	25	21	50
4	192	16	31	22	62
5	256	17	38	23	75
6	320	18	44	24	88

Please note all rates are in kbps.

**NOTE:** Quality does not apply to PCM stream. For PCM stream bitrate is calculated by the following equation: (sample rate)\*(Number of channels)\*16, [bps].

- Stereo mode – selecting stereo mode. Supported modes are Stereo, Joint Stereo or Dual Channels.
- CRC - selecting whether MP3 stream to contain information on error detection.
- Emphasis – selecting the emphasis to be applied. Supported values are 50µs, CCITT J.17 and NO emphasis.

**NOTE:** These parameters apply only to MP3 stream.

### Stream Server Settings

- Name – this is the encoder’s name displayed as name of the stream.
- Port – a field where TCP port of the stream server must be inserted. Default value is 5000.
- Pre-buffer – initial amount of data sent to the client. Large value decreases startup delay caused by buffering on the client side. This also introduces latency in the audio. Latency is bitrate dependent and can be estimated by the formula:  

$$\text{Latency} = (\text{PreBuffer} \times 8) / \text{BitRate}, [\text{sec}].$$
 Default value is 96k.
- Max connections – maximum number of simultaneous connected clients. This value can be in the range from 1 to 10. Default value is 2.

### RTP Settings

If DB9000-TX is used as a RTP Sender, the decoders’ Server Address and Port should be filled in the respective fields:

- Address – URL or IP Address of the RTP Receiver.
- Port – UDP port of the RTP Receiver.
- Ext. header – RTP Extension header present in stream. Used for compatibility with some RTP receivers. By default the option is set to *Not present*.

### Icecast Settings

If DB9000-TX is used as an Icecast Source Mount point, Encoder IP Address and Port should be filled in. The username and password are used to secure the connection. Make sure to enter the same information on both sides of the connection.

- Mount point – specify the Icecast Mount point. The Mount Point should be written without the leading slash. For example - `stream9`, instead of `/steam9`.
- Address – URL or IP Address of the Icecast Receiver. The address should be written without the `http//`, just `stream.vendor.com`
- Port – TCP port of the Icecast Receiver.
- Username – Username for Authentication with Icecast Receiver.
- Password – Password for Authentication with Icecast Receiver.

Status | Configuration | Factory Defaults | Reboot | Firmware Update

Network | IP Audio | COM Port

**RS-232 Settings**

Baudrate: 9600

**Ethernet to RS-232 Redirector**

Port: 8001

Password:

Save

**RS-232 settings**

**Baudrate:**  
RS-232 port baudrate.  
Default: 9600.

**Ethernet to RS-232 Redirector**

**Port:**  
Ethernet to RS-232 redirector TCP port.  
Default: 8001.

**Password:**  
Password for the Ethernet to RS-232 redirector. It is used to restrict the access to RS-232 from the network. If Password is left blank no security is used. Up to 15 alpha-numeric characters.  
Default: (blank).

Deva Broadcast Ltd. © 2011

Model: DB9000-TX • Serial: 110307001

## RS-232 Settings

- Baudrate - select RS-232 COM port baudrate. Default value is 9600.
- Port - a field where TCP port of the RS-232 Redirector must be inserted. This is the port to which your software should connect to communicate with any external device connected to the RS-232 Com Port. Default value is 8001.
- Password - Password for the RS-232 Redirector. These are the first symbols your software must send to authenticate itself to the Redirector. If left blank, NO security is used. Default value is *pass*. Maximum 15 alpha-numeric characters can be used.

## Applying New Settings

In order new settings to take effect, it is necessary to press the [Save] button. Please keep in mind that some of the new settings can reset DB9000-TX.

## FACTORY DEFAULT SETTINGS



Restoring DB9000-TX to its Factory Defaults can be done by following the next steps:

- Press the “Restore” button.
- A new window will appear:

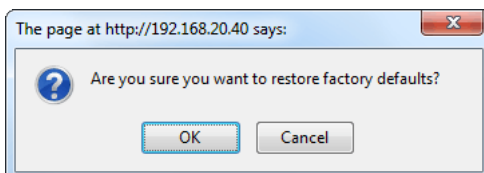

- Confirm that you want to restore factory defaults.
- Wait for the process to complete.

All the settings will be restored to their factory defaults except the Network Settings, which will remain the same.

Upon completion of the process DB9000-TX settings will have the following values:

#### **Audio Default Settings**

- Input: analog
- A/D amplifier gain: 0 dB
- Channels: 2
- Encoder + Sample rate: MPEG 1/48 kHz
- Quality: 6 Excellent
- Stereo mode: Stereo
- CRC: ON
- Emphasis: None

#### **Network Default Settings**

All General Network Settings will remain unchanged.

#### **WEB Server Default Settings**

All WEB Server Settings will remain unchanged.

#### **SNMP Default Settings**

- Agent : Disabled
- Agent Port: 161
- Community: DEVA9000
- Manager IP: 0.0.0.0
- Manager Port: 162
- Agent ID: 0

#### **Stream Server Default Settings**

- Name: DB9000-TX
- Port: 5000
- Pre-buffer: 96k
- Max connections: 2

#### **RS-232 Default Settings**

- Baudrate: 9600
- Port : 8001
- Password: pass

#### **RTP Settings**

- Port: 5004

#### **Icecast Settings**

- Port: 5555
- Username: source
- Password: pass

## HARDWARE RESET

---

This process will fully restore DB9000-TX to its Factory Defaults, including the Network settings. Hardware Reset can be done by following the next steps:

- Disconnect the power supply cable from the unit.
- Locate the RESET button on Rear panel.
- Press and hold the RESET button.
- Connect the power supply cable to the unit.
- Keep the RESET button pressed until the POWER led starts blinking.
- Release the RESET button.
- Wait for DB9000-TX to reboot with the factory default settings.

Upon completion of the process DB9000-TX settings will have the following values:

### Network Default Settings

- DHCP: enabled

### WEB Server Default Settings

- Port: 80
- Username: user
- Password: pass

All other settings will have the factory default values described in chapter [“Factory Default Settings”](#).

**NOTE:** Once the process is completed, the DHCP Client will be enabled. The DB9000-TX will obtain IP Address from DHCP server shortly.

**ATTENTION:** Please note that the WEB Server’s Port, Username and Password will be changed, so it is possible the page not to be loaded after restoring factory defaults. You may be asked to re-enter the encoder’s address and/or username and password.

## REBOOTING



To Reboot the DB9000-TX, follow the steps listed below:

- Press the “Reboot” button.
- The following warning window will appear:

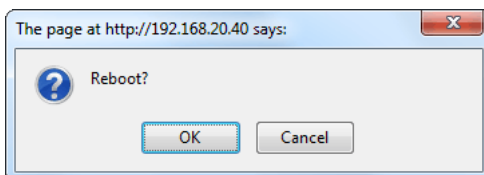

- Confirm that you want to reboot the encoder.
- Wait for the process to complete.

## FIRMWARE UPDATE

Status | Configuration | Factory defaults | Reboot | Firmware update

**Firmware:**  
Main: v1.0.259, Feb 18 2011 11:54:31

**Update Firmware:**  
File:  Browse...  
Upload

**Update Firmware**  
File:  
Select firmware file to upload.

Deva Broadcast Ltd. © 2011 Model: DB9000-TX • Serial: 110307001

To update the device firmware, follow the steps listed below:

- Press [Browse] and select the new firmware file.
- After having pressed the [Upload] button, a dialog window will appear.

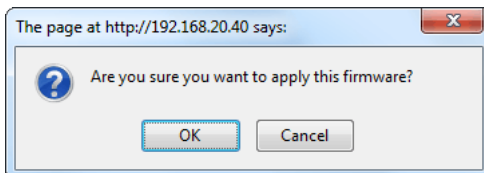

- Confirm the firmware update and wait for the process to complete.

**IMPORTANT NOTE:** If the firmware is downloaded from [www.devabroadcast.com](http://www.devabroadcast.com), the file must be unzipped prior to the upgrade.

## **CONNECTING TO THE STREAM SERVER**

---

To listen to the stream audio, please follow the next steps:

- Open an audio player supporting streaming audio
- Select “Play URL”
- Insert device’s address and port. For example: `http://192.168.0.2:5000/`
- Wait to be connected

## UPnP discovery in Local Networks

DB9000-TX implements UPnP which lets you easily find it in your local network. For this purpose your system should have UPnP enabled ([see “UPnP Activation” on page 39](#)). To discover the device follow the next steps:

- Connect the device to the local network.
- Open “My Network Places” on your computer.
- Find the decoder’s icon.
- Double click it to open the DB9000-TX web interface.

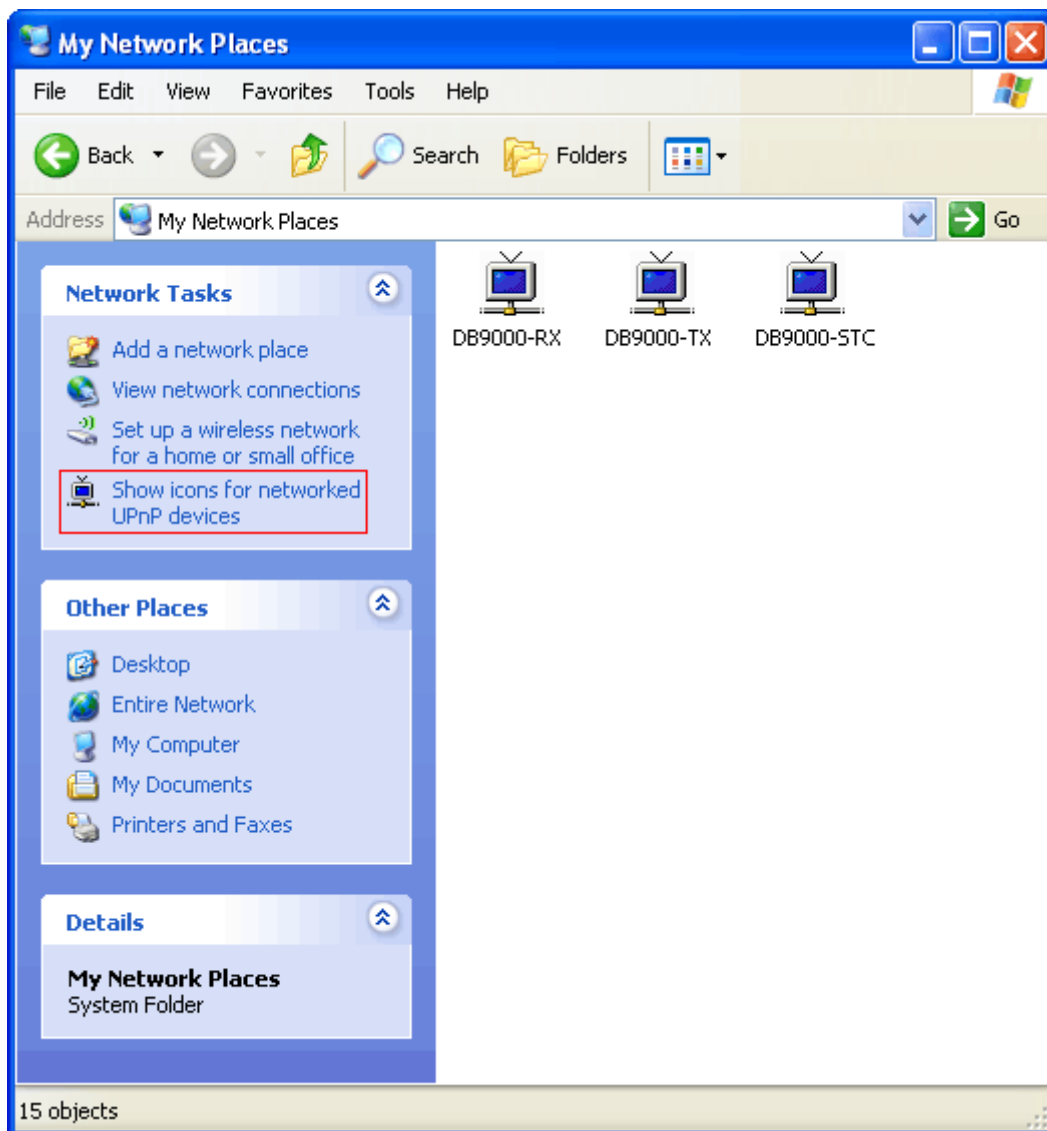

## UPnP Activation

**NOTE:** The following explanations apply to Windows XP SP2 or SP3! If you use another operating system, please contact your system administrator.

Open “My Network Places”. If you have the caption displayed in the picture below, click on it. Then click “Yes” and wait for the process to complete. Now you should see the device. If you still have troubles finding the device, please see

<http://support.microsoft.com/kb/941206> or contact your system administrator.

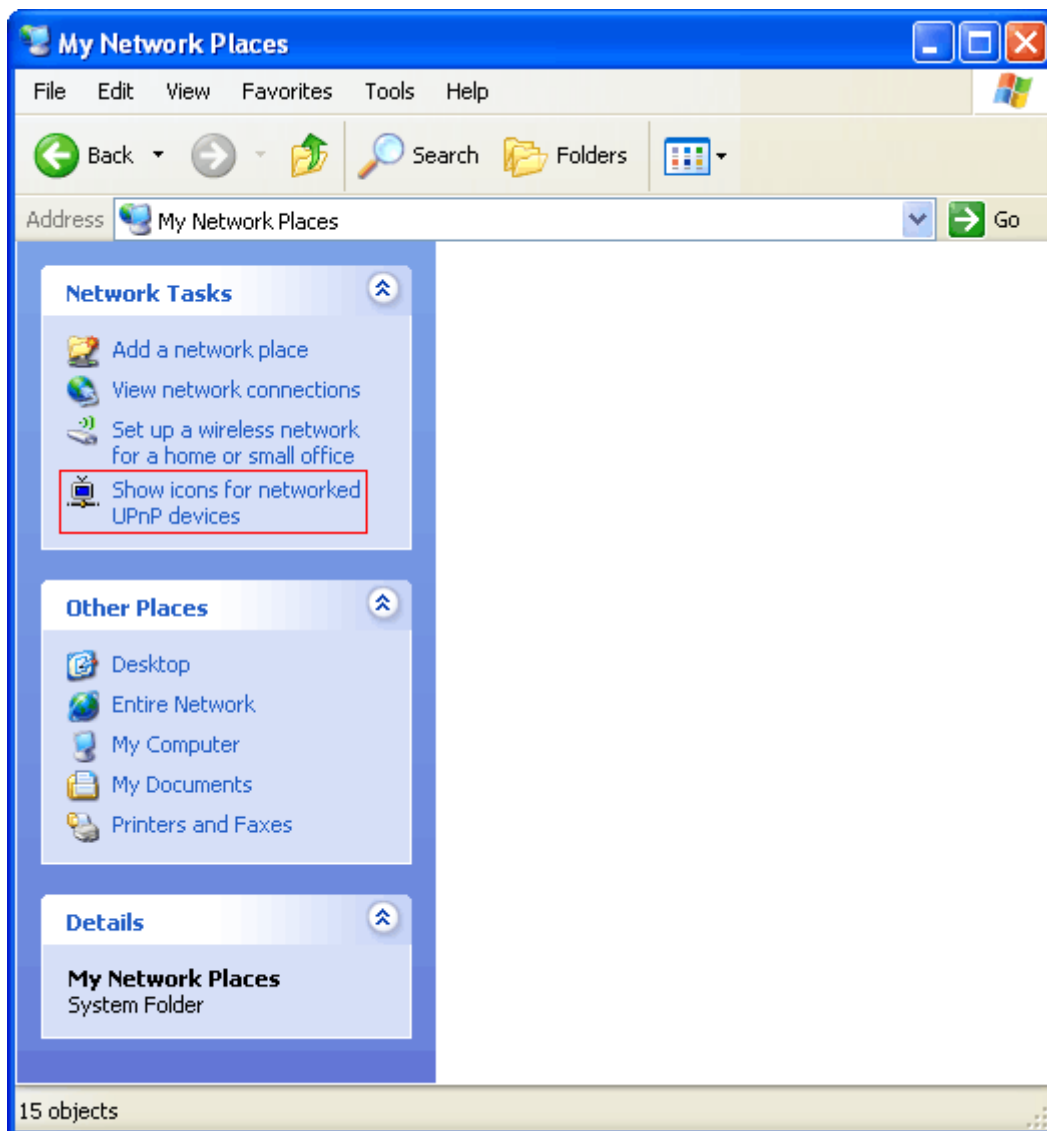

## WARRANTY TERMS AND CONDITIONS

**I. TERMS OF SALE:** DEVA Broadcast Ltd. products are sold with an understanding of “full satisfaction”; that is, full credit or refund will be issued for products sold as new if returned to the point of purchase within 30 days following their receipt, provided that they are returned complete and in an “as received” condition.

**II. CONDITIONS OF WARRANTY:** The following terms apply unless amended in writing by DEVA Broadcast Ltd.

**A.** The Warranty Registration Card must be completed and returned to DEVA Broadcast Ltd. within 10 days of delivery. Product registration can also be done digitally at <https://www.devabroadcast.com/members/product-registration>, after registering on our website, within 10 days of delivery.

**B.** This Warranty applies only to products sold “as new.” It is extended only to the original end-user and may not be transferred or assigned without prior written approval by DEVA Broadcast Ltd.

**C.** This Warranty does not apply to damage caused by improper mains settings and/or power supply.

**D.** This Warranty does not apply to damage caused by misuse, abuse, accident or neglect. This Warranty is voided by unauthorized attempts at repair or modification, or if the serial identification label has been removed or altered.

**III. TERMS OF WARRANTY:** DEVA Broadcast Ltd. products are warranted to be free from defects in materials and workmanship.

**A.** Any discrepancies noted within TWO YEARS of the date of purchase will be repaired free of charge, or the equipment will be replaced with a new or remanufactured product at DEVA Broadcast Ltd. option.

**B.** Parts and labor for factory repair required after the two-year Warranty period will be billed at prevailing prices and rates.

### IV. RETURNING GOODS FOR FACTORY REPAIR:

**A.** Equipment will not be accepted for Warranty or other repair without a Return Material Authorization (RMA) number issued by DEVA Broadcast Ltd. prior to its return. An RMA number may be obtained by placing an RMA request at <https://www.devabroadcast.com/rma>. The number should be prominently marked on the outside of the shipping carton.

**B.** Equipment must be shipped prepaid to DEVA Broadcast Ltd. Damage sustained as a result of improper packing for return to the factory is not covered under terms of the Warranty and may occasion additional charges.

### V. UPDATES TO THE TERMS OF SERVICE:

For the most up-to-date, valid, and accurate terms, conditions, and product documentation, please visit the official DEVA Broadcast Ltd. website downloads section at <https://www.devabroadcast.com/downloads/deva-documents>. Printed documents may not reflect recent amendments. Reviewing the current online versions ensures you have the latest information.



## PRODUCT REGISTRATION CARD

- All fields are required, or warranty registration is invalid and void

Your Company Name \_\_\_\_\_

Contact \_\_\_\_\_

Address Line 1 \_\_\_\_\_

Address Line 2 \_\_\_\_\_

City \_\_\_\_\_

State/Province \_\_\_\_\_ ZIP/Postal Code \_\_\_\_\_

Country \_\_\_\_\_

E-mail \_\_\_\_\_ Phone \_\_\_\_\_ Fax \_\_\_\_\_

Which DEVA Broadcast Ltd. product did you purchase? \_\_\_\_\_

\_\_\_\_\_  
\_\_\_\_\_

Product Serial # \_\_\_\_\_

Purchase date \_\_\_\_ / \_\_\_\_ / \_\_\_\_

Installation date \_\_\_\_ / \_\_\_\_ / \_\_\_\_

\_\_\_\_\_  
Your signature\*

\*Signing this warranty registration form you are stating that all the information provided to DEVA Broadcast Ltd. are truth and correct. DEVA Broadcast Ltd. declines any responsibility for the provided information that could result in an immediate loss of warranty for the above specified product(s).

**Privacy statement: DEVA Broadcast Ltd. will not share the personal information you provide on this card with any other parties.**