

MAINTENANCE AND OPERATION
INSTRUCTION MANUAL

DB8000

Silence Monitor
&
Backup Audio Player



Contents

Introduction	5
Typographic conventions	6
<i>Product Description</i>	7
<i>Product Features</i>	8
<i>Technical Specifications</i>	9
Safety Warning	11
Operating Recommendations	12
Panel Indicators and Connectors	13
<i>Front Panel</i>	13
<i>Rear Panel</i>	13
AC Mains Power	14
<i>Fuse holder</i>	14
<i>Mains Voltage Selector</i>	14
<i>Power cord</i>	14
<i>Ground Loops</i>	14
<i>Voltage Selector Switch & Fuse Holder's location</i>	15
Getting Started	16
<i>Connection</i>	16
<i>Network Settings</i>	17
<i>Network Discovery</i>	17
<i>Network Security Recommendations</i>	18
Menu Structure and Navigation	19
<i>Main Menu</i>	19
Operation	20
<i>Audio Levels Adjustment of Backup Audio Sources</i>	20
<i>Backup Source Priority Setting</i>	20
<i>DTMF Settings</i>	21
<i>MP3 Player Settings</i>	22
<i>MP3 Player Mode Settings</i>	22
<i>MP3 Player Mode configuration</i>	22
<i>MP3 Player Equalizer Settings</i>	23
<i>Silence Detector Settings</i>	24
<i>Network Settings</i>	26
<i>IP router and Port Translation</i>	27
<i>Required ports for Server and Client services and applications</i>	27
<i>FTP Server Settings</i>	28
<i>E-Mail Notifications</i>	30
<i>SNMP Settings</i>	31
<i>Memory Card</i>	32
<i>Reset to Factory Defaults</i>	32
<i>Device Info</i>	33
<i>Exit</i>	33

Firmware Upgrade.....	34
Appendix A	35
<i>List of DB8000 Factory Default Settings</i>	<i>35</i>
Appendix B	36
<i>List of DB8000 Jumper Settings.....</i>	<i>36</i>
<i>DB8000 jumpers location</i>	<i>37</i>
<i>DB8000 configuration with impedance 10 kΩ and gain 0 dB of the main and aux inputs</i>	<i>38</i>
<i>DB8000 configuration with impedance 600 Ω and gain -6 dB of the main and aux inputs</i>	<i>39</i>
WARRANTY TERMS AND CONDITIONS.....	40
Product Registration Card.....	41

THIS PAGE
IS INTENTIONALLY
LEFT BLANK

Introduction

DEVA Broadcast Ltd. is an international communications and high-technology manufacturing organization, its corporate headquarters and facility located in Burgas, Bulgaria. The company serves the broadcast and corporate markets worldwide – from consumers and small businesses to the largest global organizations. It is dedicated to the research, design, development and provision of advanced products, systems and services. DEVA Broadcast launched its own brand back in 1997 and has nowadays evolved to become known as a market leader and internationally reputed manufacturer of user-friendly, cost-effective and innovative broadcast products.

Creativity and innovation are deeply woven into DEVA Broadcast corporate culture. Through successful engineering, marketing and management our team of dedicated professionals creates future-oriented solutions to improve customers' performance. You may rely that all issues communicated to our crew would be addressed accordingly. We pride ourselves on our pre and post-sales support and purchase services, which along with the outstanding quality of our radio gear have won us due respect and the market authority position.

DEVA Broadcast best-of-breed solutions have become the best sellers for our partners. The strategic partnerships which have been formed with industry leaders during all these years that we have been operating on the broadcasting market, have proved us a reliable business partner and a valuable asset, as our dealers worldwide would confirm. In constant pursuit of precision and long-term satisfaction, DEVA Broadcast enhances the reputation of our partners and clients alike. Furthermore, we have already a proven merit as a credible partner provider.

Our portfolio offers complete line of high quality and competitive products for FM and Digital Radio, Radio Networks, Telecommunication Operators and regulation authorities. For almost two decades of intensive software and hardware development, we have achieved a unique price-performance and endurance of our product lines. Our company's multitude of equipment and services is in line with the latest technologies and key trends. The most recognizable characteristics attributed to DEVA Broadcast products are their clear-cut, streamlined design, easiness of use and cost-effectiveness: simplicity of forms but multiplicity of functions.

For us there is no stage when we deem that we have reached the most satisfactory level in our work. Our engineers are in constant pursuit of new ideas and technologies to be captured in DEVA Broadcast solutions. Simultaneously, a strict control is being exercised at each step of any new development. Experience and hard work are our fundament but the continuous improving process is what we never leave aside. DEVA Broadcast participates on a regular basis in all landmark broadcasting events, not only to promote its products, but to exchange valuable know-how and experience. We are also engaged in international large-scale projects involving radio and audio solutions which makes us even more competitive on the global market.

All DEVA Broadcast products are developed and produced in accordance with the latest ISO 9001 quality control standards.

Typographic conventions

The following table describes important conventions used in the manual.

Convention and Style	Description	Examples
<i>Menu > Sub Menu > Menu Command</i>	A menu item(s) and menu command that you need to click in sequence	Click <i>Settings > General</i>
[Button]	Interface Interactive buttons	Press [OK] to save the changes
NOTE	Important notes and recommendations	NOTE: The notification will appear only once
<u>“Reference Name” on Page XXX</u>	References and links	refer to <u>“New Connection”</u> (see <u>“Monitoring” on page 56</u>)
Example	Used when example text is cited	Example for E-mail Notification: Date: 04 Nov 2013, 07:31:11

PRODUCT DESCRIPTION

The best device to fight the dreaded dead air problem is the DB8000 by DEVA Broadcast Ltd. It is designed and built to be simple, flexible, reliable and easy for integration with the existing setups: from a single station to large radio networks. The basic principle of DB8000 is that this unit can detect the silence and start playback of a preliminary created play list on the built-in MP3 player. As an addition, if power failure is detected, the MAIN Audio inputs will switch directly to the Audio outputs. Once the power is restored, the DB8000 will resume its proper operation.

The MP3 backup audio files and play lists can be uploaded in the DB8000 from your PC using any FTP client. The audio storage capacity of DB8000 is 2 Giga Bytes.

The DB8000 provides additional security in case of loss of audio at the inputs. The audio backup is presented as an integrated auxiliary audio input for external program backup audio source and built-in MP3 audio player. Internal bass and treble controls module allow advanced audio adjustment of the MP3 backup audio.

The unit has DTMF remote control features. Preliminary assigned up to 3 digits DTMF tone combination can change the audio source input or it just can start playing from the play list of the built-in MP3 Audio Player. Through this feature the DB8000 can be used for local content or regional advertisement spots insertion.

PRODUCT FEATURES

- Automatic changeover to backup program line on main audio loss
- Automatic activation of continuous backup built-in MP3 Audio Player if the secondary source is not available
- Response time adjustable from 1 second to 255 seconds
- Passive through audio switching
- Compatible with all analog program sources
- Selectable Backup Audio Source Priority
- Continuous backup from built-in MP3 Audio Player with 2GB Internal Memory
- Advance Bass and Treble controls for the MP3 Audio Player
- Built-in DTMF remote control system for source selection
- Capable of over 24 hours of non-repeating audio playback
- SNMP Control and Notification
- E-mail Client
- Easy Device Remote Manager
- Professional Balanced Stereo analog inputs and outputs on XLR connectors
- Digital Volume Control of the Backup Sources
- Headphones Jack on the front panel for local monitoring of the Audio Signal
- Professional 19 inches, 1U aluminum rack mount chassis
- Wide Range Internal Power Supply 100-240VAC 50-60Hz
- Easy Installation and Operation
- Firmware Upgrade Enabled

TECHNICAL SPECIFICATIONS

Main Audio Inputs	
Connectors	Balanced XLR-3
Input Impedance	600 Ω , Balanced with RF Filter
Normal Input circuit	passively connected to the output
Auxiliary Audio Input	
Connectors	Balanced XLR-3
Input Impedance	600 Ω
Level	2 ranges: 0 dBu or +6 dBu Jumper selectable, with software adjustments
Backup Audio MP3 Player Source	
Storage Capacity	2GB Internal Memory SD Card
File types supported	MPEG1 layer III MPEG2 layer III MPEG2.5
MP3 bit rates supported	8-320 kbps and VBR
Sample rates supported	48, 44.1, 32, 24, 22.05, 16, 12, 11.025, 8 kHz
Audio Output	
Connectors	Balanced XLR-3
Output Impedance	
Normal output circuit	Passively connected to main analog inputs
Backup output circuit	Active, Balanced 600 Ω
Silence Detector Thresholds and Switching timers	
Silence Sensitivity Range	Adj. from -40 dBu to 0 dBu
Backup Start Time	Adj. from 0 sec to 255 sec
Main Signal Recovery Time	Adj. from 0 sec to 255 sec
Audio Performances	
Frequency Response	± 0.5 dB, 5 Hz-20 kHz
Audio Separation	>90 dB (typically 100 dB)
Noise	Better than -90 dB
Distortion	<0.5%THD
Main Signal Recovery Time	Adj. from 0 sec to 255 sec
Storage	
Capacity	2GB Built in Memory Card
Data formats	*.MP3; *.M3U for Playlists
User interface	
Indicators	4 LEDs and Navigation Buttons (on front panel)
Headphone output	1/4" (6.35mm) phone jack (on front panel)
Display	Superb 2x40 characters, LCD

Front Panel's Headphones Output	
Connector	Stereo, 1/4" (6.35mm) phone jack
Volume	Adjustable
TCP/IP Communication	
Type	RJ45 Ethernet 10M Base-T Port
Connector	RJ45, rear panel
Operating conditions	
Temperature	-15°C to 55°C
Humidity	< 95%, non-condensing
Altitude	0 to 5000m above sea level
EMC immunity	6V/m
Power Requirement	
Power supply	110/220 V (internal switch)
Connector	IEC320, rear panel
Size and Weight	
Dimensions (W x H x D)	1U, 19" x 1.7" x 6.9"
Weight	8 lbs

Safety Warning

ALWAYS OBSERVE THE SAFETY PRECAUTIONS.

Careful observance of the safety precautions will help prevent physical injury, damage of the equipment, and extend the equipment life.

- The servicing of electronic equipment should be performed only by qualified personnel;
- Before removing the covers the unit must be switched off and the mains cable unplugged;
- When the equipment is open, the power supply capacitors should be discharged using a suitable resistor;
- Never touch the wires or the electrical circuits;
- Use insulated tools only;
- Never touch the metal semiconductor. They might carry high voltages;
- For removing and installing electronic components, follow the recommendations for handling MOS components.
- Do not remove the factory sticker from the equipment. It contains information as regards the name, serial number and MAC address of the device.
- To join the equipment to the mains supply, use the power cord purchased with the equipment.

Operating Recommendations

To ensure normal operation of the DEVA unit, we recommend following the instructions listed below.

- Install the unit in places with good air conditioning. The unit is designed to operate within the ambient temperature range of 10 to 50°C. The equipment rack should be ventilated in order for the device to keep its internal temperature below the maximum ambient temperatures;
- We do not recommend installation in rooms with high humidity, dusty places or other aggressive conditions;
- Although the device is intended to be installed closed to exciters or transmitters, we do recommend the device to be located away from abnormally high RF fields.
- Use only checked power supply cables. We strongly recommend the usage of shielded cables;
- Connect the DEVA unit to reliable power supply sources only. In case of unstable power supply, please use Uninterruptible Power Supply (UPS);
- Use the device only with its top cover on to avoid electromagnetic anomalies. Otherwise, this may cause problems with the normal functionality of the unit;
- To ensure normal remote operation of the unit, make sure to connect the device to a good quality Internet connection;
- For the normal operation of your DEVA device, check if the network settings past through all the required data traffic.

Panel Indicators and Connectors

FRONT PANEL

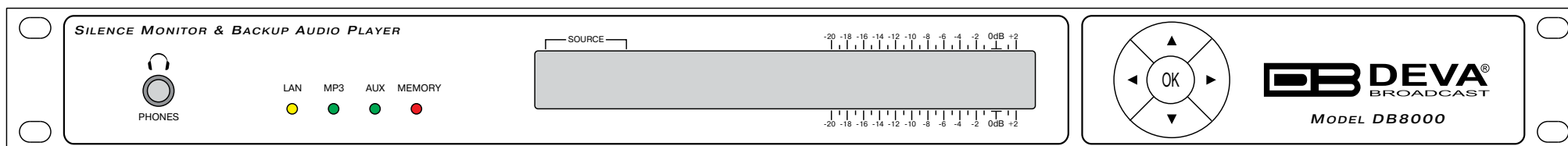

- PHONES – Stereo 1/4” (6.3 mm) jack output for headphones;
- LAN – indicates LAN presence;
- MP3 – indicates MP3 Player active;
- AUX – indicates Auxiliary Source Input active;
- MEMORY – blinks when the MicroSD Card is in use, or when the Card is full (memory overflow);

REAR PANEL

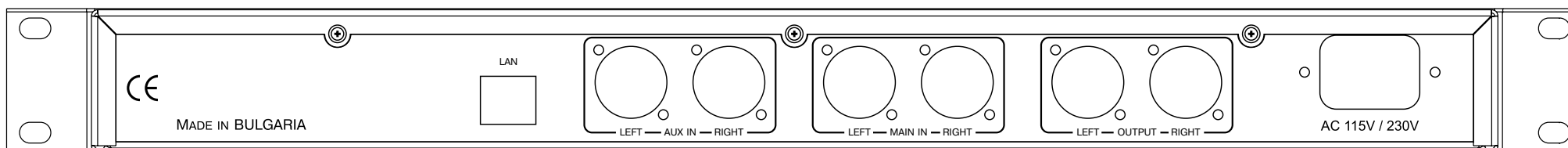

- LAN – RJ-45 connector for TCP/IP connection;
- AUX IN (LEFT and RIGHT) – Auxiliary Source Input connectors, XLR type;
- MAIN IN (LEFT and RIGHT) – Main Source Input connectors, XLR type;
- OUTPUT (LEFT and RIGHT) – Output Connectors, XLR type;
- AC 115V/230V – Mains connector, IEC320 type;

AC Mains Power

FUSE HOLDER

The fuse holder is placed inside the unit, next to the voltage selector. Apply downward pressure and pull the cap outward to access the 5mm mains fuse. The reverse process will release the cap.

MAINS VOLTAGE SELECTOR

Before connecting the AC Power, make sure that the internal Power Switch is in accordance with the mains supply at your location. The Power Supply Factory Settings are:

- 100 - 240 VAC
- 1 Amp Fuse

CAUTION: Permanent damage will result if improper AC supply voltage is applied to the device. The warranty DOES NOT cover damages caused by applying improper supply voltage or usage of improper fuse.

POWER CORD

The detachable IEC-type power cord is supplied with the unit. The individual cord conductors may be color-coded in either of two ways:

- 1) In accordance with US standards:
BLACK = AC "HOT"
WHITE = AC NEUTRAL
GREEN = EARTH GROUND

- 2) To European CEE standards:
BROWN = AC "HOT"
BLUE = AC NEUTRAL
GREEN/YELLOW = EARTH GROUND

GROUND LOOPS

Because the unbalanced INPUTS/OUTPUTS of the device are chassis-ground-referenced, a mains frequency or INPUT/OUTPUT ground loop could be formed between the input or output cable shield grounds and the AC power cord ground. A 'ground-lifting' AC adapter may help in this situation, although the chassis must be properly grounded for safety purposes. In general, the equipment being installed in a rack will satisfy the safety requirement.

VOLTAGE SELECTOR SWITCH & FUSE HOLDER'S LOCATION

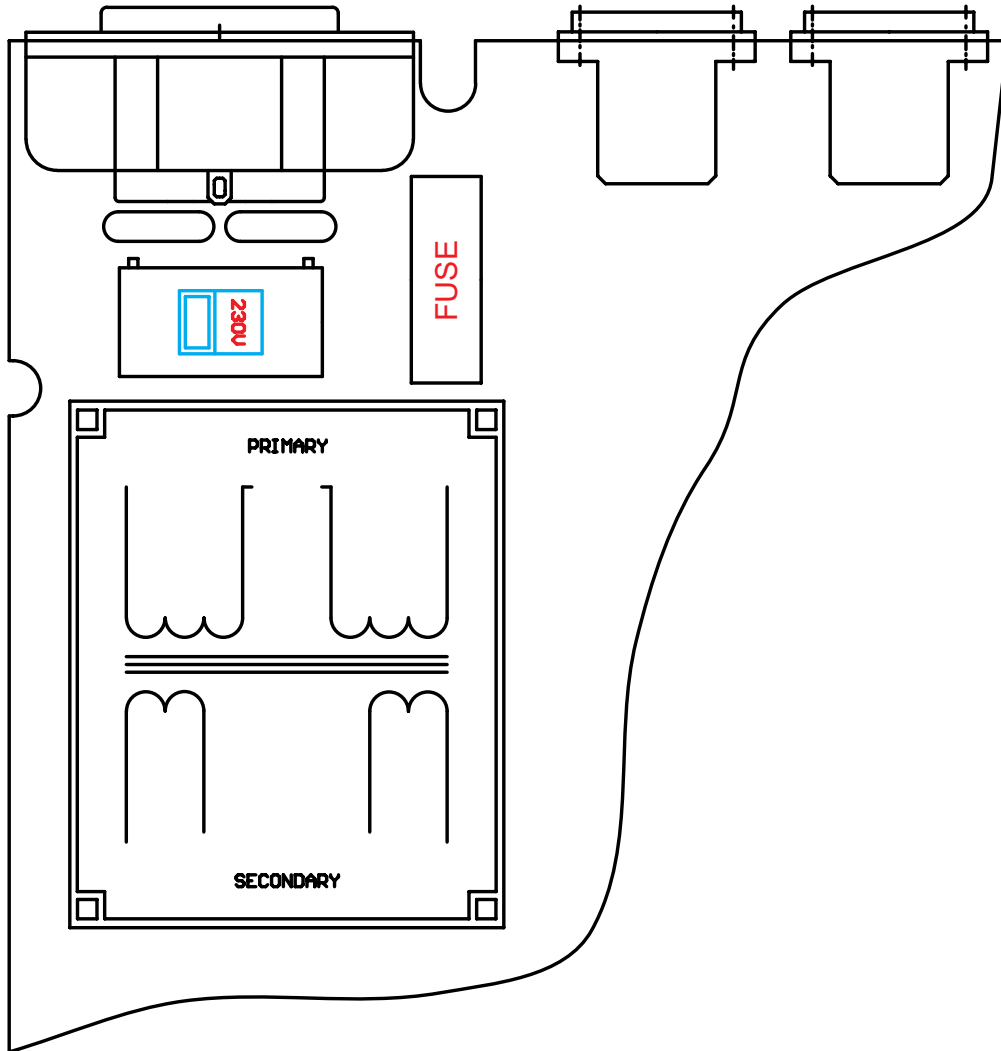

Getting Started

In order for the normal operation of the DB8000 to be guaranteed, you will need fulfill the following conditions:

1. Standard Ethernet 10/100M connection;
2. Correctly assigned Network configuration and device settings.

To make sure that all the conditions are fulfilled please, follow the instructions below.

CONNECTION

1. Install the unit on its operation place;
2. Using the provided power cable, connect the unit to the power supply network;
3. Connect the antenna cable to the RF antenna input connector located on the rear panel of the device;
4. Connect the DB8000 to the TCP/IP network using direct network cable;
5. **IF GSM OPTION IS SUPPORTED** - Using the connection cable provided, connect the optional GSM modem. In order for better GSM network coverage to be achieved, please select proper place for the GSM antenna.

NOTE: The GSM antenna must be installed far enough from the monitoring devices. The GSM modem radiates RF signal that may cause spurious emissions that will may interfere with the accuracy of the measurements.

NETWORK SETTINGS

After connecting the network cable the Led 'LAN' located on the rear panel must be ON or flashing. The next and most important step for configuration is the adjustment procedure of the Network Communication. The settings shown below are Default Network Settings:

DHCP	Enabled
IP	Assigned by DHCP
Mask	Assigned by DHCP
Gateway	Assigned by DHCP
DNS	Assigned by DHCP
HTTP Port	80

NETWORK DISCOVERY

This is a network setting that defines whether your computer can see (find) other computers and devices on the network and whether other computers on the network can see your computer. By default, Windows Firewall blocks network discovery but you can enable it.

1. Open Advanced sharing settings by clicking the Start button, and then on "Control Panel". In the search box, type "network", click "Network and Sharing Center", and then, in the left pane click "Change advanced sharing settings";
2. Select your current network profile;
3. Click "Turn on network discovery", and then click save changes.

NOTE: If you're prompted for an administrator password or confirmation, type the password, provide confirmation or contact your system administrator.

If you have already enabled this function on your computer DB8000 will be automatically added to the Device list section. The device will be ready for usage and no additional adjustments will be required except user name and password.

NOTE: If the port is different than the default one (80), it is necessary to specify it, for example:
`http://192.168.1.2:9000`

ATTENTION: Depending on Internet Protocol Settings, the assigned IP address may not be visible outside your local network, thus the device may be accessed only within that network. Consult with your network administrator for the appropriate IP settings.

NETWORK SECURITY RECOMMENDATIONS

1. It is not recommended the DB8000 to be directly connected to the Internet. This may lead to unregulated access and/or problematic operation of the device. To ensure secure connection, we recommend the device to be installed behind a router with an active firewall.
2. If remote access to the device is needed, we recommend using VPN to the router or the port of the relevant service (WEB, SNMP, Application, etc.) to be properly NAT forwarded.
3. If NAT forward is used, it is highly recommended random ports of your choice to be used. Not the standard ones (80 for WEB, 161 for SNMP, etc.).
4. Using DMZ connection is not recommended.
5. Make sure to change the standard access credentials (usernames and passwords, SNMP communities).

For detailed information as regards the recommendations listed above or need of further instructions, please contact your network administrator.

Operation

AUDIO LEVELS ADJUSTMENT OF BACKUP AUDIO SOURCES

Levels of the Backup Audio Signal Sources can be digitally adjusted. The range is -63dB to 0dB for the AUX Input and -70dB to 0dB for the MP3 Player. The output level can be decreased by - 6dB using jumpers JP13 and JP14 ([see “List of DB8000 Jumper Settings” on page 36](#)).

Level Adjustment of both the Alternative Audio Signal Sources can be made via the front panel Keyboard. Follow the instruction:

1. Open the Main Menu press the **OK** button;
2. The following Sub-menu will open:

```
1. Audio Levels Adjust:  AUX Input:  0dB
                        MP3 Input:  0dB
```

3. Press the **OK** button again;
4. Using the **UP** and **DOWN** keys move the cursor and select the Backup Source to be adjusted;
5. Press the **OK** button. The edited value will start blinking;
6. Using **UP** or **DOWN** keys enter the new settings;
7. Press the **OK** button to confirm;
8. Press the **LEFT** key to exit the Sub-menu or keep it pressed for more than 2 seconds to exit to the Main Menu;

BACKUP SOURCE PRIORITY SETTING

One of the Backup Sources (Aux Input or MP3 Player) will be automatically fed to the DB8000 Output Circuit if Main Signal interruption occurs or when its level drops down below a specified Threshold. To select the priority Backup Sources priority, follow the steps listed below:

1. Enter the Main Menu and press the **OK** button;
2. Press the **DOWN** key and select Sub-menu **2. Backup Source Priority**.

```
2. Backup Source Priority:  AUX Input
                           MP3 Input
```

3. Press the **OK** button;
4. Using the **UP** and **DOWN** keys select the **MP3 INPUT** or **AUX INPUT**; Selected Backup Audio Source will move up on the top;
5. Press the **LEFT** key to exit the Sub-menu or keep it pressed for more than 2 seconds to revert back to the Main Menu;

DTMF SETTINGS

There is a standard DTMF decoder built into DB8000 and connected to the MAIN Input. The standard symbols for any DTMF decoder are used: – 0-9 figures, ‘A’ through ‘D’ letters and the special symbols * and #. The Backup Signal Sources can be controlled by applying DTMF codes. Using “Start” and “Stop” codes the following operations can be performed:

- Aux Start Code – the Aux Input Source will be activated and connected to the Output Circuit of DB8000;
- Aux Stop Code – the Aux Input Source will be deactivated and the Main Input Signal Source will be connected to the Output Circuit of DB8000;
- MP3 Start Code – the MP3 Player will be activated and connected to the Output Circuit of DB8000;
- MP3 Stop Code – the MP3 Player will be deactivated and the Main Input Signal Source will be connected to the Output Circuit of DB8000;

Please note there must be no coincidence between the codes for any of the above operations.

It must be noted that the Silence Detector ([see “Silence Detector Settings” on page 24](#)) will be switched off when a DTMF Start Code sent to any of the Backup Signal Sources. The Silence Detector will be activated back again once a DTMF Stop Code is received.

To configure DTMF Codes, the user should follow the steps listed below:

1. Open the Main Menu and press the **OK** button;
2. Press the **DOWN** key and select Sub-menu **3. DTMF Setting**.
3. Press the **OK** button again. Now the **DOWN** key can be used to see the whole Sub-menu. The DTMF Sub-menu looks as depicted below:

```
3. DTMF Settings      AUX Start code: ____  
                      AUX Stop code: ____
```

```
3. DTMF Settings      MP3 Start code: ____  
                      MP3 Stop code: ____
```

4. Using the **UP** and **DOWN** buttons, move the cursor to select the parameter to be edited.
5. Press the **OK** button and the editing field will start blinking. The new values are assigned via the **UP** or **DOWN** buttons. To move between the parameter’s fields use **LEFT** or **RIGHT** keys.
6. Press the **OK** button to confirm selected code.
7. Press the **LEFT** key to exit to the Sub-menu or keep it pressed for more than 2 seconds to revert back to the Main Menu;

NOTE: DTMF Codes to control the Backup Signal Sources can be 2 or even 1 symbol instead of 3 symbols.

MP3 PLAYER SETTINGS

How can a playlist file be made?

1. All backup audio files, and the play list must be located in a single folder named MP3.
2. Use a plain text editor to create a file named playlist.m3u.
3. The file should be stored in the same directory where the MP3 files are (folder MP3);
4. The play list should contain only the names of the files, without path. Note that the file names must be no longer than 8 symbols followed by 3 symbols extension. For example:
Track1.mp3
5. Each track name should be on a new line.
6. The song titles should be written in the order that should be played.

IMPORTANT NOTE: If there is a file name longer than 8 symbols, the MP3 Player will indicate an **Error Message** and the file will not be accepted and played.

MP3 Player Mode Settings

There are two modes of MP3 playback:

- List – all the files will be played in the order they are stored in the “playlist.m3u“;
- Shuffle – MP3 files will be played in random order.

MP3 Player Mode configuration

1. Enter the main menu and press the **OK** button;
2. Press the **DOWN** key and select Sub-menu 4. MP3 Player Settings.



```
4. MP3 Player Settings    MODE: List  
                        Equalizer
```

3. Press the **OK** button;
4. Using the **UP** or **DOWN** keys move the cursor and select Mode;
5. Press the **OK** key. Selected mode will start blinking;
6. Using the **UP** or **DOWN** key select List or Shuffle;
7. Confirm selection by pressing the **OK** button;
8. Press the **LEFT** key to exit to the Sub-menu or keep it pressed for more than 2 seconds to revert back to the Main Menu;

MP3 Player Equalizer Settings

In order to improve the Output Audio Signal's quality of the MP3 Player there are built-in digital Bass and Treble Equalizers. Frequencies to be enhanced for the Bass Equalizer are ranging from 20Hz to 150Hz and amplified between 0dB and 15dB. For the Treble Equalizer frequencies to be enhanced are within the range of 1kHz to 15kHz and the levels are between -8dB to 7dB.

To configure the Bass and Treble Enhancers, next steps are to be followed:

1. Upon entering the Main Menu press the **OK** button;
2. Press the **DOWN** key and select Sub-menu **4. MP3 Player Settings**.

```
4. MP3 Player Settings      MODE: List  
                           Equalizer
```

3. Press the **OK** button;
4. Using the **UP** or **DOWN** keys move the cursor down and select **Equalizer**;
5. Press the **OK** button. The **DOWN** key can be used to navigate through this Sub-menu. This is how the Equalizer's Sub-menu looks like:

```
4. Equalizer                Bass Freq : 90Hz  
*Bass Settings*           Bass Level: 0dB
```

```
4. Equalizer                Treble Freq : 1kHz  
*Treble Settings*         Treble Level: 0dB
```

6. Using **UP** or **DOWN** key move the cursor and select the parameter to be edited;
7. Press the **OK** button again and selected parameter will start blinking;
8. Using **UP** or **DOWN** key to enter the needed value;
9. Press the **OK** button to confirm the new value;
10. Press the **LEFT** key to exit to the Sub-menu or keep it pressed for more than 2 seconds to revert back to the Main Menu;

SILENCE DETECTOR SETTINGS

IMPORTANT NOTE: In case of power failure, the MAIN Audio inputs will switch directly to the Audio outputs. Once the power is restored, the DB8000 will resume its proper operation.

The Silence Detector is intended to monitor the levels of the signals applied at the DB8000's Inputs. The Input Signal will be changed from the Main Input to some of the Alternative Signal Sources as defined by Priority Settings. Levels of the parameters affecting Silence Detector performance are User defined:

- Threshold Level (in dB)
- Action Delay (in seconds)
- Release Delay (in seconds)

When the Main Input Signal drops below the *Threshold Level*, *Action Delay* Timer will be activated. Meaning that signal from the highest in priority Backup Source will be fed to DB8000's Output. The last operation will be carried out only if NO signal with level above the *Threshold Level* appears at the Main Input for the time of *Action Delay*. Before switching over to the Alternative Source Input, the availability of the signal will be verified. The timer will be switched back to idle state if a signal passing over the *Threshold Level* appears at the Main Input before time elapsing (as defined by Action Delay). Signal presence and signal levels of the Inputs with higher priority will be continuously monitored while the Backup Signal Source is in use.

Release Delay will be activated when the DB8000 starts using any of the Backup Signal Sources. *Release Delay* is the time to elapse before the DB8000 will switch from Backup Signal Source to the Main Input.

To apply the needed settings on the parameters listed above, follow the steps:

1. Upon entering the Main Menu press the **OK** button;
2. Press the **DOWN** key and select Sub-menu **5. Silence Detector**.
3. Press the **OK** button. Use the **DOWN** key to navigate through the Sub-menu.

```
5. Silence Detector  Threshold Lvl: -25dB
**Settings**        Action Delay: 5s
```

```
5. Silence Detector  Action Delay: 5s
**Settings**        Release Delay: 5s
```

4. Using the **UP** and **DOWN** keys, move the cursor and select parameter to be edited;
5. Press the **OK** button again and the editing field will start blinking. Using the **UP** and **DOWN** buttons, select the needed values;
6. Press again **OK** button to confirm selection;
7. Press the **LEFT** key to exit to the Sub-menu or keep it pressed for more than 2 seconds to revert back to the Main Menu;

A graphical view of Silence Detector performance is shown below:

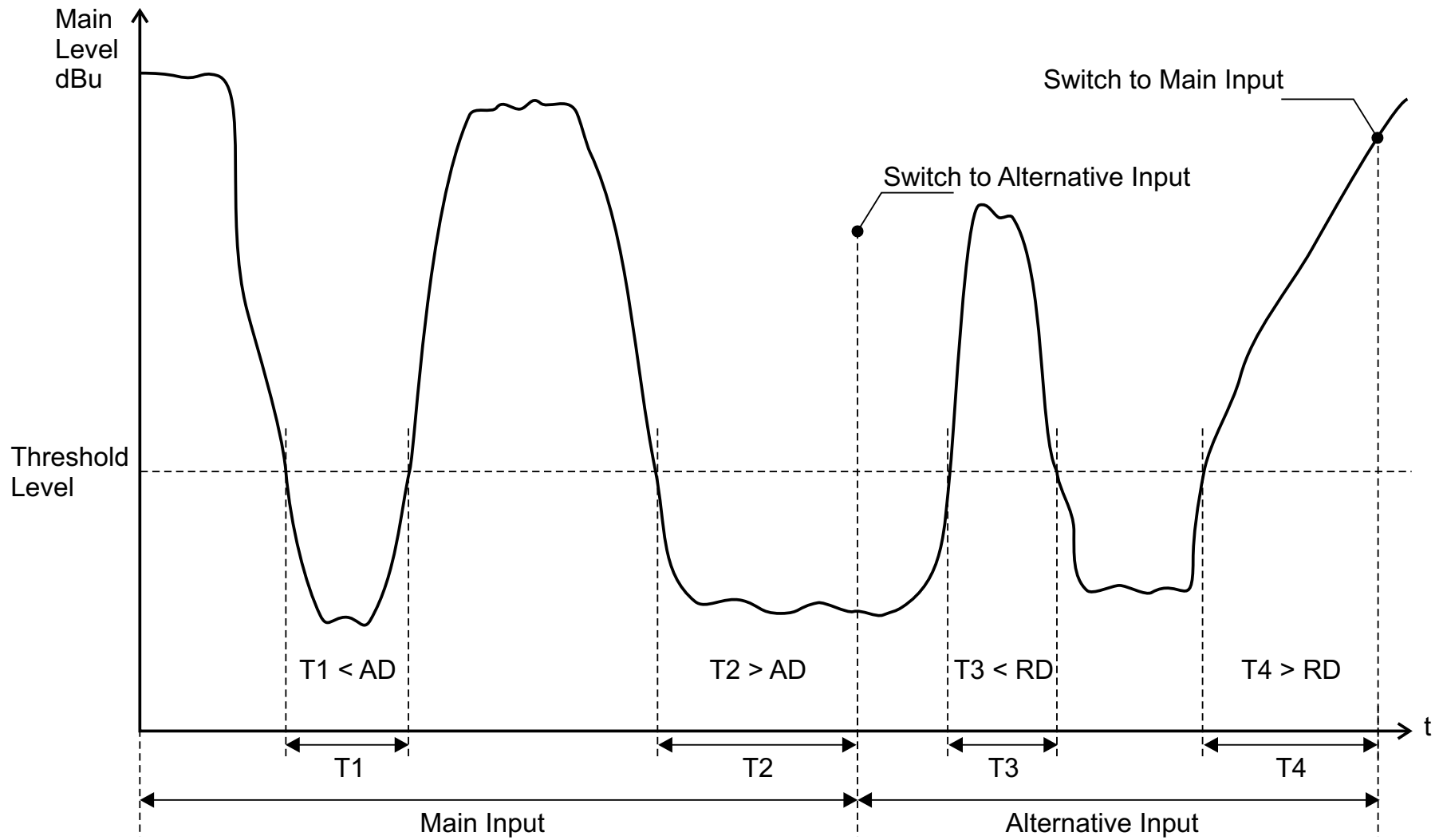

AD - Action Delay, RD - Release Delay

NETWORK SETTINGS

In order for the DB8000 to be able to join a Local Area Network (LAN) or Wide Area Network (WAN) and use the built-in FTP Server, settings as IP address, Gateway and Subnet Mask must be defined. This can be made by following the steps listed below:

1. Enter the Main Menu press the **OK** button;
2. Press the **DOWN** key and select Sub-menu **6. Network Settings**.
3. Then press the **OK** button. The **DOWN** key is used to navigate through the Sub-menu.

```
6. Network      IP address:192.168.001.002
Settings        Gateway:192.168.001.001
```

```
6. Network      Gateway:192.168.001.001
Settings        Mask:255.255.255.000
```

4. Using **UP** or **DOWN** keys to move the cursor, select the parameter to be edited;
5. Press the **OK** button again and the editing field will start blinking;
6. Using the **UP** and **DOWN** buttons, enter the new values. To move between the parameter's fields, use the **LEFT** or **RIGHT** keys;
7. Press again the **OK** button to confirm the selection made;
8. Press the **LEFT** key to exit to the Sub-menu or keep it pressed for more than 2 seconds to revert back to the Main Menu;

IP ROUTER AND PORT TRANSLATION

Now that broadband Internet connections are so common and NAT routers are more widespread than ever, your connection to the Internet might be going through a NAT *router* or a *firewall*. If you have a home network or DSL service, you're likely to have one of these. These devices can improve the security of your computer, and can allow a single Internet address to be shared by more than one computer on your network.

NAT stands for *network address translation* and allows multiple computers or devices to access the internet through a single internet connection and single IP address. The computers or devices on the inside of the network, known as an intranet, are given IP addresses that are non-routable (meaning non-internet addresses). The router translates the outgoing requests from your computer or device into requests from the single IP address on the WAN (or Internet side of the router). On the other hand the router will NOT forward requests originating from the outside of the network and pass them on to the local network unless very specifically configured to do so.

On the picture below is presented an example of DB8000 to router connection:

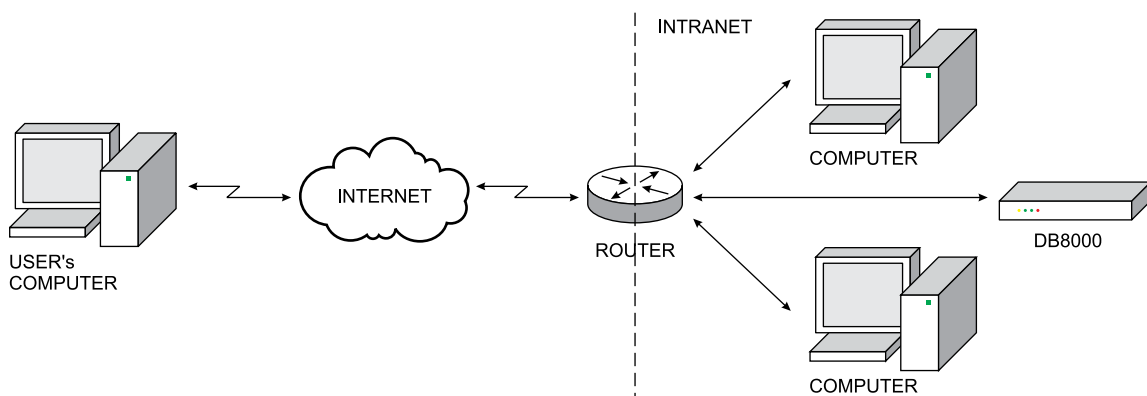

In this way, the hardware router, designed not to permit any unsolicited packets from an external host to be delivered to an internal host acts as a router firewall and can be a problem for client programs to reach your distant Deva Broadcast's device.

The solution to this problem is to configure the *port forwarding* feature of the router to allow certain packets to reach the Deva Broadcast's device. As each make and model of router has a different procedure for setting up port forwarding, please refer to the specific router's manual for guidance and further details. Usually the port forwarding can be done in the NAT section from the router's menu.

Required ports for Server and Client services and applications

The following list shows the ports that must be open on your router or firewall to allow specific types of data flows through the router:

Port Description	DB8000 Defaults
FTP Command Port	21
FTP Data Port	20

NOTE: If you customize the DB8000 FTP ports, please consider the same port values must be used to configure router's forwarding.

FTP SERVER SETTINGS

Access to the built-in FTP server is controlled by applying Username and Password with maximum length of 6 symbols each of them. It must be noted that the FTP Server works in Passive mode and it is necessary a Wide Area Network (WAN) address to be specified.

If DB8000 is connected directly to the computer where the FTP Client is installed then the WAN IP Address must be equal to that of IP Address in Sub-menu 6. Network Settings (WAN IP address = IP address). Direct DB8000 connection is illustrated below:

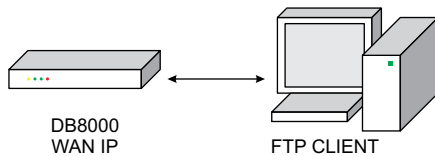

If a networking device (router for example) is used, then the DB8000 WAN IP Address must be equal to that of the router as illustrated below:

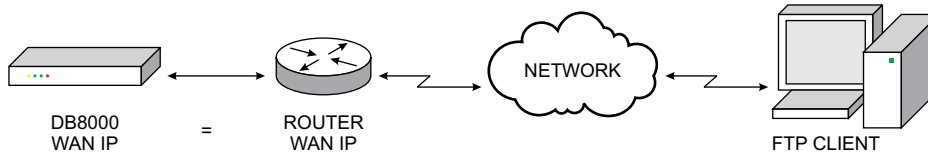

Command and Data Ports are the other two parameters that must be specified in order to establish FTP connection.

NOTE: As the DB8000's FTP server can manage only one connection at a certain time, please configure your FTP client to use only one simultaneous connection.

Configuration of the FTP Server can be accomplished following the next steps:

1. While in the Main Menu press the **OK** button;
2. Press the **DOWN** key and select Sub-menu 7. FTP Server Settings.
3. Press the **OK** button. The **DOWN** key can be used to navigate through this Sub-menu which looks like below:

```
7. FTP Server      Username: admin
Settings          Password: deva
```

```
7. FTP Server      WAN IP: 192.168.001.002
Settings          COMMAND PORT: 00021
```

```
7. FTP Server      COMMAND PORT: 00021
Settings          DATA PORT: 00020
```

4. Using **UP** or **DOWN** keys move the cursor and select the parameter to be edited;
5. Press the **OK** button once again and the editing field will start blinking. Values that are needed can be selected by **UP** or **DOWN** keys. To move between the parameter's fields use **LEFT** or **RIGHT** keys;
6. Press the **OK** button to confirm selection;
7. Press the **LEFT** key to exit to the Sub-menu or keep it pressed for more than 2 seconds to exit to the Main Menu;

NOTE: Please note that the maximum length of Password and Username is 6 symbols.

E-MAIL NOTIFICATIONS

DB8000 has built-in E-mail Client to generate e-mail notifications in case of Input Signal source change. E-mails are sent to predefined recipient and consist of short text describing source change - Main, Aux or Backup. The E-mail Client could be enabled or disabled any time. Before using E-mail Client, the option should be configured properly and in accordance with the used E-mail Server. The E-mail Client could establish SSL connection if such is required.

Configuration of the E-mail Client can be accomplished following the next steps:

1. Enter the Main Menu and press the **OK** button;
2. Press the **DOWN** key and select Sub-menu **8. E-mail Client Settings**.
3. Press the **OK** button. The **DOWN** key is used to navigate through the Sub-menu.

```
8. E-mail Client      Alarm Alert:Disabled
Settings             Account Settings
```

```
8. E-mail Client      Alert E-mail Send To
Settings             Device ID
```

4. Using the **UP** or **DOWN** keys move the cursor and select the parameter to be edited;
5. Press the **OK** button to enter the sub menu and the editing field will start blinking. To select a value, use the **UP** or **DOWN** keys. To move between the parameter's fields, use **LEFT** or **RIGHT** keys;
6. Press the **OK** button to confirm selection;
7. Press the **LEFT** key to exit to the Sub-menu or keep it pressed for two seconds or more to exit to the Main Menu;

This is how the E-mail Client Account Settings look like:

```
8.1 Login:db8000@devabroadcast.com
Password:db8000
```

```
8.1 SMTP Server:mail.host.bg
SMTP Port:00025      SSL:Disabled
```

Sub-menu for E-mail Recipient Address:

```
8.2 E-mail Recipient Address
To:db8000@devabroadcast.com
```

Sub-menu for Device ID:

```
8.3 DEVICE ID:DB8000
```

The Device's ID is included in the notification text and is intended to make the messages more recognizable, if more than one device is in use.

SNMP SETTINGS

DB8000 supports Simple Network Management Protocol (SNMP) v2c.

To configure the SNMP, follow the steps listed below:

1. Enter the Main Menu and press the **OK** button;
2. Press the **DOWN** key and select Sub-menu **9. SNMP Settings**.
3. Press the **OK** button and use the **DOWN** key to navigate through the menu.

```
9. SNMP          Agent:Disabled
Settings        Traps:Disabled
```

```
9. SNMP          Agent Community:DEVA8000
Settings        Traps Community:DEVA8000
```

```
9. SNMP          Agent Port:00161
Settings        Traps Port:00162
```

```
9. SNMP          Traps IP:192.168.001.001
Settings
```

4. Using the **UP** or **DOWN** keys move the cursor and select the parameter to be edited;
5. Press the **OK** button again and the editing field will start blinking. To select the edited values, use the **UP** and **DOWN** keys. To move between the parameter's fields use **LEFT** or **RIGHT** keys;
6. Press the **OK** button to confirm selection;
7. Press the **LEFT** key to exit to the Sub-menu or keep it pressed for more than 2 seconds to exit to the Main Menu;

NOTE: Device will send TRAP Alerts only if they are enabled.

MEMORY CARD

If needed, the user can format the SD card via the **8. Memory Card**. Information on the available memory space is available in the same sub-menu.

Please note that **FORMAT** is the only parameter that could be edited within this Sub-menu and **SPACE** is for informative purposes only.

To format the card or check its status, follow the steps listed below:

1. Upon entering the Main Menu press the **OK** button;
2. Press the **DOWN** key and select Sub-menu **10. Memory Card**.



```
10. Memory Card          Space:1887MB
                          Format:NO
```

3. Pressing the **OK** button will select **Format**;
4. Press the **OK** button again so that the parameter could start blinking;
5. Using the **UP** and **DOWN** keys select **YES** or **NO**;
6. Press the **OK** button to confirm the changes;
7. Press the **LEFT** key to exit to the Sub-menu or keep it pressed for more than 2 seconds to exit to the Main Menu;

RESET TO FACTORY DEFAULTS

To reset DB8000 to its Factory Defaults follow the steps listed below:

1. Upon entering the Main Menu press the **OK** button;
2. Press the **DOWN** key and select Sub-menu **11. Factory Defaults**.



```
11. Factory Defaults      Confirm:NO
```

3. Pressing the **OK** button will select **Confirm:NO**;
4. Press the **OK** button again so that the parameter could start blinking;
5. Using **UP** or **DOWN** keys select **YES** or **NO**;
6. Press the **OK** button to confirm;
7. Press the **LEFT** button to exit to the Sub-menu or keep it pressed for more than 2 seconds to revert back to the Main Menu;

DEVICE INFO

Basic information about the device can be found here. To enter the menu, follow the steps listed below:

1. Upon entering the Main Menu press the **OK** button;
2. Press the **DOWN** key and select Sub-menu **12. Device Info.**
3. The following Sub-menu will be displayed:

A screenshot of a terminal window showing the '12. Device info' sub-menu. The text is displayed in a monospaced font on a dark blue background. The first line shows '12. Device info' followed by 'HW Rev:XX' and 'FW Rev:XX'. The second line shows 'S/N:XXXXXXXX' followed by 'MAC:00-04-A3-XX-XX-XX'.

4. To exit to the Main Menu press the **LEFT** key and keep it pressed for more than 2 seconds.

The following information can be obtained from this Sub-menu:

- Serial Number;
- Hardware Version;
- Software Version;
- Firmware Version;
- MAC Address of the built-in NIC (Network Interface Card);

EXIT

A screenshot of a terminal window showing the '13. EXIT' sub-menu. The text '13. EXIT' is displayed in a monospaced font on a dark blue background.

Pressing the **OK** button will revert the user back to the Main Menu Page.

Firmware Upgrade

If needed, DB8000's firmware can be updated. Updating the device with the latest firmware available may add new functions and improve the general performance if the unit.

The latest firmware and a document explaining the process of firmware upgrade can be downloaded from DEVA Broadcast's web site: <http://www.devabroadcast.com/downloads>

Appendix A

LIST OF DB8000 FACTORY DEFAULT SETTINGS

FTP Data Port	2020
FTP Command Port	2021
FTP User Name	admin
FTP Password	deva
IP Address	192.168.1.2
Gateway	192.168.1.1
Subnet Mask	255.255.255.0
WAN Address	192.168.1.2
AUX Level	0 dB
MP3 Level	0 dB
Source Priority	MP3
Player Mode	List
Bass Frequency	130 Hz
Bass Level	0 dB
Treble Frequency	5 kHz
AUX Start Code	not assigned
AUX Stop Code	not assigned
MP3 Start Code	not assigned
MP3 Stop Code	not assigned
Threshold Level	-25 dB
Action Delay	5 sec
Release Delay	5 sec
E-mail Alarm Alert	enabled
E-mail Login	db8000@devabroadcast.com
E-mail Password	db8000
SMTP Server	mail.host.bg
SMTP Port	25
SSL	disabled
E-mail Recipient	db8000@devabroadcast.com
Device ID	DB8000
SNMP Agent	disabled
SNMP Traps	disabled
Agent Community	DEVA8000
Traps Community	DEVA8000
Agent Port	161
Traps Port	162
Traps IP	192.168.1.1

Appendix B

LIST OF DB8000 JUMPER SETTINGS

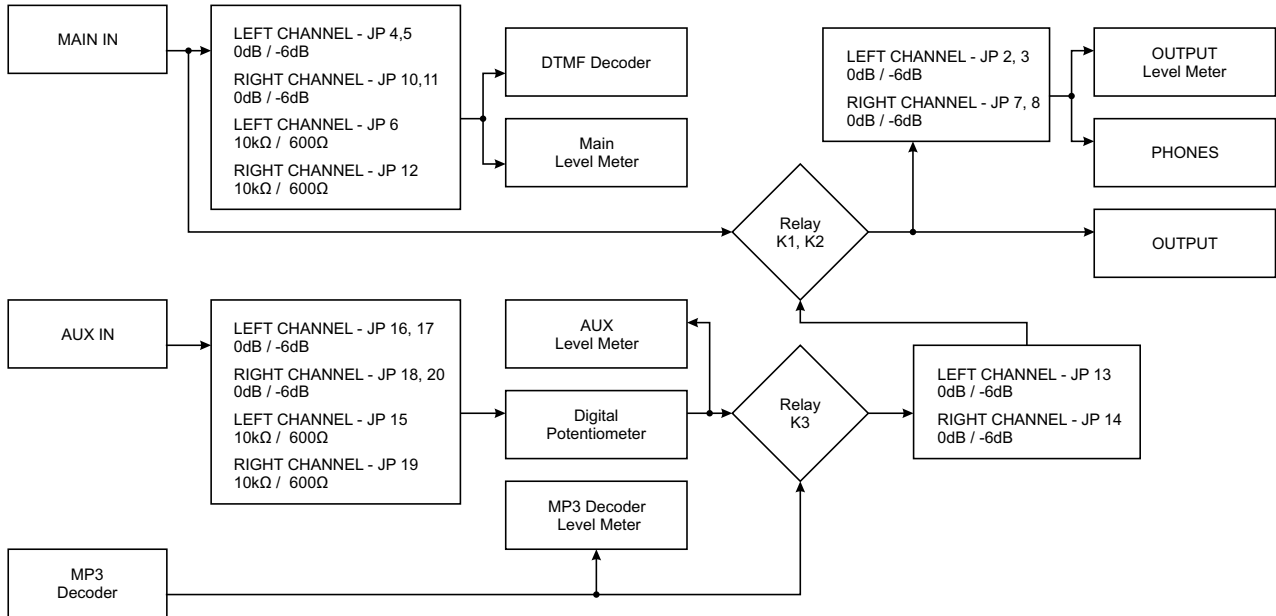

Input Gain = 0 dB

MAIN INPUT	LEFT	Channel	Jumper	Position
		JP4	1-2	
		JP5	1-2	
		JP2	1-2	
	RIGHT	JP3	1-2	
		JP10	1-2	
		JP11	1-2	
		JP8	1-2	
JP7	1-2			

Input Gain = -6 dB

MAIN INPUT	LEFT	Channel	Jumper	Position
		JP4	2-3	
		JP5	2-3	
		JP2	2-3	
	RIGHT	JP3	2-3	
		JP10	2-3	
		JP11	2-3	
		JP8	2-3	
JP7	2-3			

Input Gain = 0 dB

AUX INPUT	LEFT	Channel	Jumper	Position
		JP17	1-2	
		JP16	1-2	
		JP13	1-2	
	RIGHT	JP2	1-2	
		JP3	1-2	
		JP18	1-2	
		JP20	1-2	
JP14	1-2			
JP8	1-2			
JP7	1-2			

Input Gain = -6 dB

AUX INPUT	LEFT	Channel	Jumper	Position
		JP17	2-3	
		JP16	2-3	
		JP13	2-3	
	RIGHT	JP2	2-3	
		JP3	2-3	
		JP18	2-3	
		JP20	2-3	
JP14	2-3			
JP8	2-3			
JP7	2-3			

Input Impedance = 600Ω

MAIN INPUT	Channel	Jumper	Position
	LEFT	JP6	2-3
	RIGHT	JP12	2-3

Input Impedance = 10kΩ

MAIN INPUT	Channel	Jumper	Position
	LEFT	JP6	1-2
	RIGHT	JP12	1-2

Input Impedance = 600Ω

AUX INPUT	Channel	Jumper	Position
	LEFT	JP15	2-3
	RIGHT	JP19	2-3

Input Impedance = 10kΩ

AUX INPUT	Channel	Jumper	Position
	LEFT	JP15	1-2
	RIGHT	JP19	1-2

DB8000 JUMPERS LOCATION

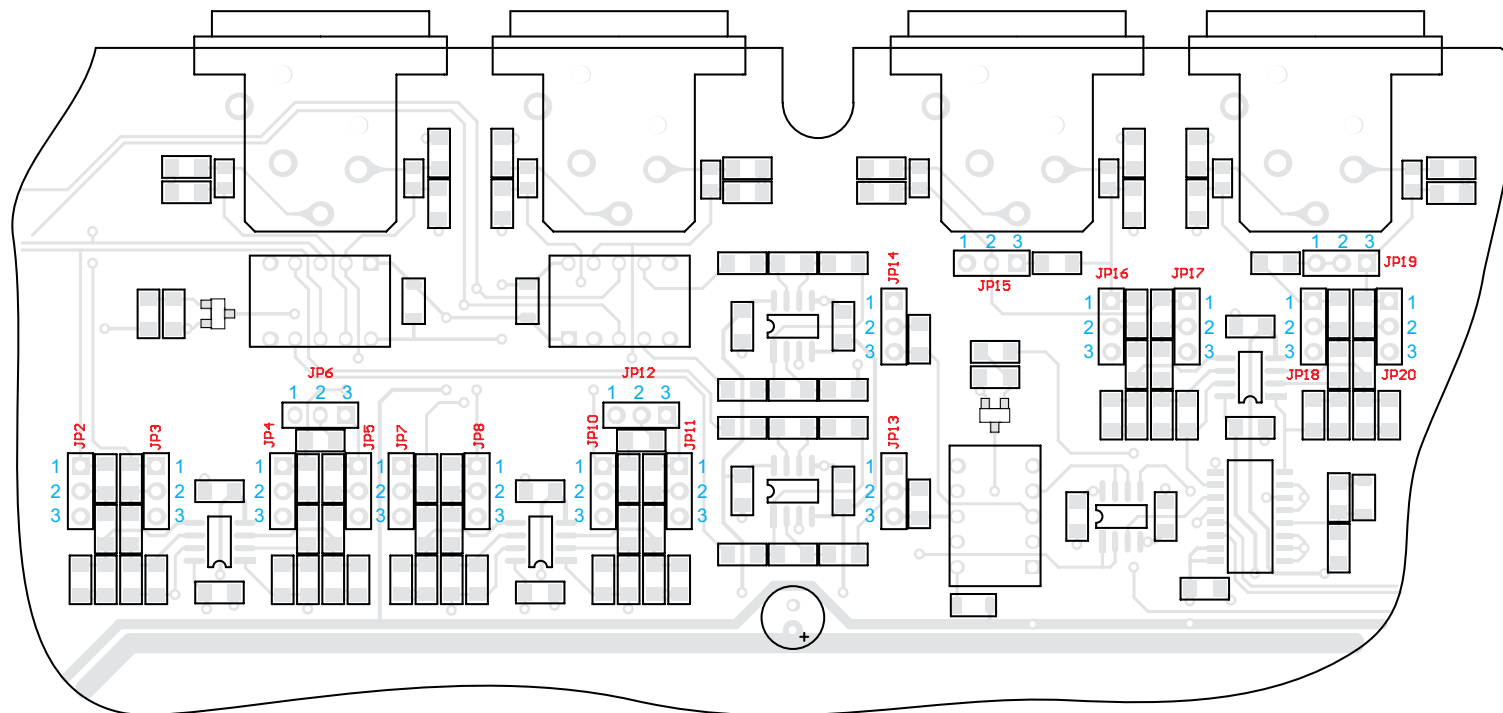





JP6, JP12, = 10 kΩ
JP15, JP19 = 600 Ω

JP2, JP3, JP4, JP5,
JP7, JP8, JP10, JP11 = 0 dB
JP13, JP14, JP16, JP17 = -6 dB
JP18, JP20

DB8000 CONFIGURATION WITH IMPEDANCE 10 kΩ AND GAIN 0 dB OF THE MAIN AND AUX INPUTS



JP6, JP12,  = 10 kΩ
JP15, JP19  = 600 Ω

JP2, JP3, JP4, JP5,
JP7, JP8, JP10, JP11
JP13, JP14, JP16, JP17
JP18, JP20  = 0 dB  = -6 dB

DB8000 CONFIGURATION WITH IMPEDANCE 600 Ω AND GAIN -6 dB OF THE MAIN AND AUX INPUTS



JP6, JP12, = 10 kΩ
JP15, JP19 = 600 Ω

JP2, JP3, JP4, JP5,
JP7, JP8, JP10, JP11
JP13, JP14, JP16, JP17
JP18, JP20 = 0 dB = -6 dB

WARRANTY TERMS AND CONDITIONS

I. TERMS OF SALE: DEVA Broadcast Ltd. products are sold with an understanding of “full satisfaction”; that is, full credit or refund will be issued for products sold as new if returned to the point of purchase within 30 days following their receipt, provided that they are returned complete and in an “as received” condition.

II. CONDITIONS OF WARRANTY: The following terms apply unless amended in writing by DEVA Broadcast Ltd.

A. The Warranty Registration Card must be completed and returned to DEVA Broadcast Ltd. within 10 days of delivery. Product registration can also be done digitally at <https://www.devabroadcast.com/members/product-registration>, after registering on our website, within 10 days of delivery.

B. This Warranty applies only to products sold “as new.” It is extended only to the original end-user and may not be transferred or assigned without prior written approval by DEVA Broadcast Ltd.

C. This Warranty does not apply to damage caused by improper mains settings and/or power supply.

D. This Warranty does not apply to damage caused by misuse, abuse, accident or neglect. This Warranty is voided by unauthorized attempts at repair or modification, or if the serial identification label has been removed or altered.

III. TERMS OF WARRANTY: DEVA Broadcast Ltd. products are warranted to be free from defects in materials and workmanship.

A. Any discrepancies noted within TWO YEARS of the date of purchase will be repaired free of charge, or the equipment will be replaced with a new or remanufactured product at DEVA Broadcast Ltd. option.

B. Parts and labor for factory repair required after the two-year Warranty period will be billed at prevailing prices and rates.

IV. RETURNING GOODS FOR FACTORY REPAIR:

A. Equipment will not be accepted for Warranty or other repair without a Return Material Authorization (RMA) number issued by DEVA Broadcast Ltd. prior to its return. An RMA number may be obtained by placing an RMA request at <https://www.devabroadcast.com/rma>. The number should be prominently marked on the outside of the shipping carton.

B. Equipment must be shipped prepaid to DEVA Broadcast Ltd. Damage sustained as a result of improper packing for return to the factory is not covered under terms of the Warranty and may occasion additional charges.

V. UPDATES TO THE TERMS OF SERVICE:

For the most up-to-date, valid, and accurate terms, conditions, and product documentation, please visit the official DEVA Broadcast Ltd. website downloads section at <https://www.devabroadcast.com/downloads/deva-documents>. Printed documents may not reflect recent amendments. Reviewing the current online versions ensures you have the latest information.



PRODUCT REGISTRATION CARD

- All fields are required, or warranty registration is invalid and void

Your Company Name _____

Contact _____

Address Line 1 _____

Address Line 2 _____

City _____

State/Province _____ ZIP/Postal Code _____

Country _____

E-mail _____ Phone _____ Fax _____

Which DEVA Broadcast Ltd. product did you purchase? _____

Product Serial # _____

Purchase date ____ / ____ / ____

Installation date ____ / ____ / ____

Your signature*

*Signing this warranty registration form you are stating that all the information provided to DEVA Broadcast Ltd. are truth and correct. DEVA Broadcast Ltd. declines any responsibility for the provided information that could result in an immediate loss of warranty for the above specified product(s).

Privacy statement: DEVA Broadcast Ltd. will not share the personal information you provide on this card with any other parties.