

MAINTENANCE AND OPERATION
INSTRUCTION MANUAL

Radio Explorer II

Mobile FM Radio Analyzer



50 Channel GPS Receiver



Contents

Introduction	6
Typographic conventions	7
General Information	8
Product Features	9
<i>Technical Specifications</i>	10
<i>Block Diagram</i>	12
<i>Front Panel</i>	13
<i>Rear Panel</i>	14
<i>Rear Panel GPO Terminal</i>	15
Safety Warning	16
Operating Recommendations	17
Unpacking and inspection	18
Mounting	18
<i>Rack Requirements IU</i>	18
<i>Rack Requirements Compact Units</i>	18
<i>Stand-Alone Devices</i>	18
<i>Device connection</i>	19
Getting Started	20
<i>Connection</i>	20
<i>Network Settings</i>	21
<i>Network Discovery</i>	21
<i>Network Security Recommendations</i>	22
Operating Modes	23
<i>Logger Mode</i>	23
<i>PI/CALL Campaign Mode</i>	23
<i>Interactive Mode</i>	23
Navigation through OLED Menu	24
<i>Navigational Buttons</i>	24
<i>Soft Buttons</i>	24
<i>OLED Display</i>	25
<i>Header area</i>	26
<i>Main Screen working area</i>	26
Operating Modes and Pages	27
<i>Home Page</i>	27
<i>Bandscan Page</i>	28
<i>Span control state</i>	30
<i>Marker control state</i>	32
<i>Parameter control state</i>	33
<i>Bandscan page parameters</i>	33
<i>FFT Page</i>	34
<i>Parameter Control States:</i>	35
<i>Scope Page</i>	36
<i>Parameters available:</i>	36
<i>Stereo Page</i>	37
<i>Graphs Page</i>	38

<i>Levels Page</i>	40
<i>Status Page</i>	44
<i>Status > Device</i>	44
<i>Status > IP Address</i>	44
<i>Status > GPS</i>	45
<i>Settings Page</i>	45
<i>Settings Menu screen structure</i>	46
<i>How to start a PI or Logger campaign using the front panel menu?</i>	50
Restore factory defaults	51
WEB Interface	52
<i>Manual IP Address Identification</i>	52
<i>Network discovery</i>	54
<i>Access</i>	54
<i>Main Page</i>	55
<i>RDS/RBDS Page</i>	56
<i>MPX Page</i>	57
<i>Bandscan Page</i>	58
<i>Status Page</i>	59
<i>Log Page</i>	60
<i>General Settings Page</i>	61
<i>Tuner Settings Page</i>	62
<i>Communication Settings Page</i>	63
<i>Outputs Settings Page</i>	64
<i>Other Settings Page</i>	65
<i>Firmware Update</i>	65
<i>Factory Defaults</i>	65
<i>Reboot</i>	65
<i>Storage and System Log</i>	65
<i>PI Campaign and Logger Mode</i>	66
<i>Differences between PI campaign and Logger Mode.</i>	66
<i>Which type of campaign should I choose?</i>	66
<i>RDS PI / RBDS CALL campaign - PI campaign</i>	66
<i>Logger mode</i>	66
<i>WEB Interface control options explained</i>	67
<i>Important recommendations when acquisition time is set</i>	69
<i>How to start a PI Campaign?</i>	70
<i>How to start a Logger campaign?</i>	71

Google Earth Visualization	72
List of Radio Explorer II Settings	74
Troubleshooting.....	80
APPENDIX A	81
<i>RDS: Europe vs America</i>	<i>81</i>
<i>The RDS System</i>	<i>81</i>
APPENDIX B.1	82
<i>PTY Code Description Used in RBDS Mode – North America.....</i>	<i>82</i>
APPENDIX B.2	83
<i>PTY Code Description Used in RDS Mode – Europe, Asia</i>	<i>83</i>
APPENDIX C	84
<i>RDS Applications Supported</i>	<i>84</i>
<i>AF</i>	<i>84</i>
<i>CT</i>	<i>84</i>
<i>DI</i>	<i>84</i>
<i>ECC</i>	<i>84</i>
<i>EON</i>	<i>85</i>
<i>EWS</i>	<i>85</i>
<i>FFG</i>	<i>85</i>
<i>IH</i>	<i>85</i>
<i>M/S</i>	<i>85</i>
<i>ODA.....</i>	<i>85</i>
<i>PI</i>	<i>85</i>
<i>PIN.....</i>	<i>86</i>
<i>PS</i>	<i>86</i>
<i>PTY</i>	<i>86</i>
<i>PTYN</i>	<i>86</i>
<i>RT</i>	<i>86</i>
<i>RT+.....</i>	<i>87</i>
<i>TA</i>	<i>87</i>
<i>TDC</i>	<i>87</i>
<i>TMC.....</i>	<i>87</i>
<i>TP</i>	<i>87</i>
APPENDIX D.....	88
<i>How should I configure the connection between my DEVA Device and an FTP Client?</i>	<i>88</i>
1. <i>FTP Server Settings</i>	<i>88</i>
2. <i>IP Router and Port Translation Settings.....</i>	<i>88</i>
3. <i>Example of FTP Client (FileZilla) Settings</i>	<i>89</i>
WARRANTY TERMS AND CONDITIONS.....	90
Product Registration Card.....	91

THIS PAGE
IS INTENTIONALLY
LEFT BLANK

Introduction

DEVA Broadcast Ltd. is an international communications and high-technology manufacturing organization, its corporate headquarters and facility located in Burgas, Bulgaria. The company serves the broadcast and corporate markets worldwide – from consumers and small businesses to the largest global organizations. It is dedicated to the research, design, development and provision of advanced products, systems and services. DEVA Broadcast launched its own brand back in 1997 and has nowadays evolved to become known as a market leader and internationally reputed manufacturer of user-friendly, cost-effective and innovative broadcast products.

Creativity and innovation are deeply woven into DEVA Broadcast corporate culture. Through successful engineering, marketing and management our team of dedicated professionals creates future-oriented solutions to improve customers' performance. You may rely that all issues communicated to our crew would be addressed accordingly. We pride ourselves on our pre and post-sales support and purchase services, which along with the outstanding quality of our radio gear have won us due respect and the market authority position.

DEVA Broadcast best-of-breed solutions have become the best sellers for our partners. The strategic partnerships which have been formed with industry leaders during all these years that we have been operating on the broadcasting market, have proved us a reliable business partner and a valuable asset, as our dealers worldwide would confirm. In constant pursuit of precision and long-term satisfaction, DEVA Broadcast enhances the reputation of our partners and clients alike. Furthermore, we have already a proven merit as a credible partner provider.

Our portfolio offers complete line of high quality and competitive products for FM and Digital Radio, Radio Networks, Telecommunication Operators and regulation authorities. For almost two decades of intensive software and hardware development, we have achieved a unique price-performance and endurance of our product lines. Our company's multitude of equipment and services is in line with the latest technologies and key trends. The most recognizable characteristics attributed to DEVA Broadcast products are their clear-cut, streamlined design, easiness of use and cost-effectiveness: simplicity of forms but multiplicity of functions.

For us there is no stage when we deem that we have reached the most satisfactory level in our work. Our engineers are in constant pursuit of new ideas and technologies to be captured in DEVA Broadcast solutions. Simultaneously, a strict control is being exercised at each step of any new development. Experience and hard work are our fundament but the continuous improving process is what we never leave aside. DEVA Broadcast participates on a regular basis in all landmark broadcasting events, not only to promote its products, but to exchange valuable know-how and experience. We are also engaged in international large-scale projects involving radio and audio solutions which makes us even more competitive on the global market.

All DEVA Broadcast products are developed and produced in accordance with the latest ISO 9001 quality control standards.

Typographic conventions

The following table describes important conventions used in the manual.

Convention and Style	Description	Examples
<i>Menu > Sub Menu > Menu Command</i>	A menu item(s) and menu command that you need to click in sequence	Click <i>Settings > General</i>
[Button]	Interface Interactive buttons	Press [OK] to save the changes
NOTE	Important notes and recommendations	NOTE: The notification will appear only once
<u>“Reference Name” on Page XXX</u>	References and links	refer to <u>“New Connection”</u> (see <u>“Monitoring” on page 56</u>)
Example	Used when example text is cited	Example for E-mail Notification: Date: 04 Nov 2013, 07:31:11

General Information

Dual DSP-based, compact and affordable Radio Explorer II is a product with highly evaluated performance. This device is the perfect solution for field surveys and on site monitoring of station's complete signal. A click on the button converts the Radio Explorer II into an excellent tool for analyzing of the signal strength and quality after repairs or set-up of new equipment. This cost-effective device can measure RF level, MPX deviation, Left & Right Audio levels, RF field strength, RDS and Pilot injection levels and display the measurements on the easy to read OLED Graphical display.

The Radio Explorer II is a multifunctional device designed in line with all market requirements. This mobile easy to use tool evaluates the FM broadcast band congestion and stores all important radio broadcast parameters in a Log file. The built-in FTP system allows managing of the files by an assigned schedule. All collected information is centralized in a database and can be revised, played back, and sent automatically to the qualified staff if need be.

Designed for signal surveillance, on the field where the listeners are, all that is needed is a vehicle and Radio Explorer II. There are two distinct campaign modes:

Radio Explorer II can be set to measure automatically one or multiple preselected frequencies (Up to 50);

RDS PI / RBDS Call campaign – up to 10 stations can be chosen. Radio Explorer II will automatically detect the used frequency. While the campaign is running, the chosen stations will be monitored; Radio Explorer II will automatically switch over between the variable frequencies during movement - just as the car radio of your listeners.

When the campaign is over using the supplied free of charge Windows software, the log files could be converted into KMZ format and visualized in Google Earth. Such functionality is irreplaceable when current information of the FM broadcast band congestion and coverage is needed. As an addition, the Log file can be also exported and saved as a transitional format for future analysis.

The band scan mode guarantees real-time live visualization of the FM band or a particular predefined part of it, with down to 10 kHz resolution. Radio Explorer II can be controlled through:

The built-in Web server - a standard web browser can be used to monitor its status or make some adjustments. Apple and Android devices are also supported. The Main Screen of the WEB Interface shows all mandatory parameters represented as LED readings;

The supplied free of charge DEVA Device Manager Software - easy-to-use interface allows quick and easy connection to the device. The dedicated module ensures managing of all the device's logs and displays all the events in a handy manner;

The very intuitive user interface with OLED screen, Front panel navigational and soft buttons ensures an easy usage of the device's build-in features.

Supporting both RDS/RBDS standards and measurement units, the Radio Explorer II is a suitable choice for broadcast engineers from all around the world. For better control and data representation the device can be connected to any Windows® based PC, via the LAN or USB port. Offering various bar-graphs, data plots, histograms, etc., this device will meet the expectations of the most demanding broadcasters.

Product Features

- Powerful Dual DSP-based core
- Front panel OLED Graphical Display
- Very Intuitive Application Interface
- SNMP for adjustments and control
- Full control and monitoring via LAN & USB connection
- Easy to use WEB Interface
- Maintenance via DEVA Device Manager Software
- User selectable, 87.1-108 MHz (CCIR), 65-74 MHz (OIRT), 76-95 MHz (Japan)
- Dual antenna ports supporting up to 100 dB μ V direct RF Antenna Input.
- Selectable IF bandwidth
- MPX, PILOT, RDS deviation meters and RF Field strength
- Built-in Stereo decoder; Stereo Presence Detection
- 3 General purpose outputs – GPS Fix, Multipath, Low RF Level
- LEFT and RIGHT demodulated audio level meters
- Built-in 50-channels GPS Receiver
- Measurement results visualisation in Google Earth
- Accurate front-panel metering for local use
- Professional 6 mm Headphones audio output with volume control
- RDS and RBDS decoder
- FM/RDS/RBDS Data Logger
- Built-in FTP Server for easy download of the Log files
- RDS/RBDS Stream BER meter
- Robust, custom made Metal Case for high RF immunity
- RF and RDS Measurements (real time & average)
- Audible GPS Fix Loss

TECHNICAL SPECIFICATIONS

RF INPUT	
Tuning Range	User selectable, 87.1-108 MHz (CCIR), 65-74 MHz (OIRT), 76-95 MHz (Japan)
Tuning Step	10, 20, 50, 100 kHz
Tuner Sensitivity	30 dB μ V
Antenna Ports	Dual, 2 x BNC Connectors, 50 Ω
Antenna Ports Isolation	> 40 dB
Internal Attenuator	0, 10, 20 and 30 dB
Dynamic range	100 dB
FM DEMOD	
IF Filter Bandwidth	15 Increments (27kHz - 157kHz, Auto)
Frequency Response	\pm 0.1 dB, 10 Hz to 86 kHz
MPX Power	\pm 12 dB, 20 sec. integration
Dynamic range	90 dB
STEREO DECODER	
Frequency Response (L and R)	\pm 0.1 dB, 10 Hz to 15 kHz
SNR (Stereo)	60 dB, 50 μ s de-emphasis
THD	0.15% @ 1kHz, 0.4% from 10 Hz to 15 kHz, 50 μ s de-emphasis
Separation	50 dB, 50 Hz to 10 kHz, 50 μ s de-emphasis
Crosstalk	52 dB
RDS DECODER	
Standards	European RDS CENELEC; United States RBDS NRSC
Error Correction & Counting	Yes
AF Decoding	Yes
CT (Time/Date)	Yes
PI, PTY, DI, MS	Yes
TA/TP	Yes
RT (Radio Text), RT+	Yes
PS (Program Service name)	Yes
TMC, ODA	Yes
Group Analyzer	Yes
BER Analyzer	Yes
Group Sequence Display	Yes
RDS RAW Data Display	Yes

FFT SPECTRUM ANALYSIS (RF, COMPOSITE, AUDIO)	
Signal Sources	RF (IF), MPX, Left, Right
FFT length	2048 points
Dynamic range	90 dB
SCOPE ANALYSIS (RF, COMPOSITE, AUDIO)	
Signal Sources	RF (IF), MPX, Pilot, RDS, Main, Sub, Left, Right
Record length	4096 points
Dynamic range	90 dB
METERING ACCURACY	
RF Level	±1 dB, 0 to 100 dB μ V
MPX Power	±0.2 dBr, -12 to 12 dBr, 0.1 dBr resolution
Total, Pos, Neg	±2 kHz, 10 to 100 kHz, 1 kHz resolution
Pilot, RDS	±0.5 kHz, 1 to 12 kHz, 0.2 kHz resolution
Audio	±1 dB, +10.0 to -55.0 dB, 0.1 dB resolution
OUTPUTS	
Audio (L, R)	+6 dBu, 600 Ω , balanced XLR Connector
AES3 (L, R)	5.0 Vp-p, 110 Ω , balanced XLR Connector
Alarms	Terminals on rear panel, optoisolated
Headphone	6,3mm (1/4") Phone Jack
COMMUNICATION INTERFACES	
USB	B-type Connector
Ethernet 10/100 Base-T	RJ45 Connector
GPS RECEIVER	
Number of channels	50
Antenna	Pre-amplified, 5m of cable, magnetic
Connector	SMA, rear panel
MEASUREMENT STORAGE	
Storage	2GB Build-in Memory Card
Data format	Text, CSV
OPERATING CONDITIONS	
Temperature	-15°C to 55°C
Humidity	< 95%, non-condensing
Altitude	0 to 5000m above sea level
POWER REQUIREMENT	
Power Supply	12 DC (11-15V) / 2A max at 12V
Connector	XLR (on rear panel)
SIZE AND WEIGHT	
Dimensions (W;H;D)	210 x 76 x 215 mm
Shipping Weight	2kg

BLOCK DIAGRAM

A simplified block diagram of Radio Explorer II is shown below

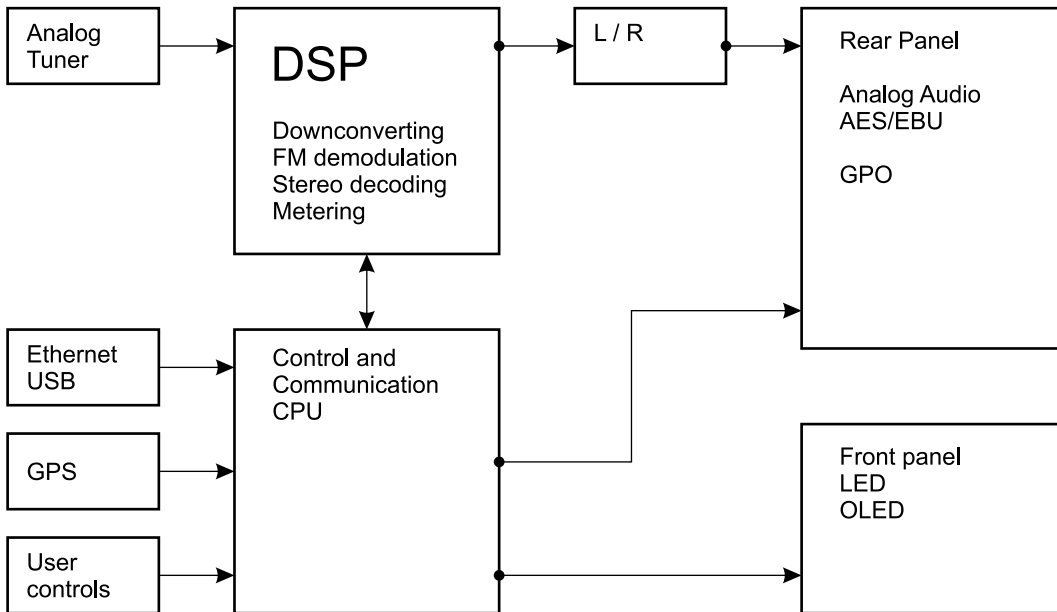

Because of the all-digital, minimalist-discrete-component nature of device circuitry, we have not provided schematic diagrams of the Radio Explorer II in this Manual. Please, note that:

**NO USER-SERVICEABLE COMPONENTS INSIDE.
REFER ALL SERVICING TO
QUALIFIED TECHNICAL PERSONNEL.**

FRONT PANEL

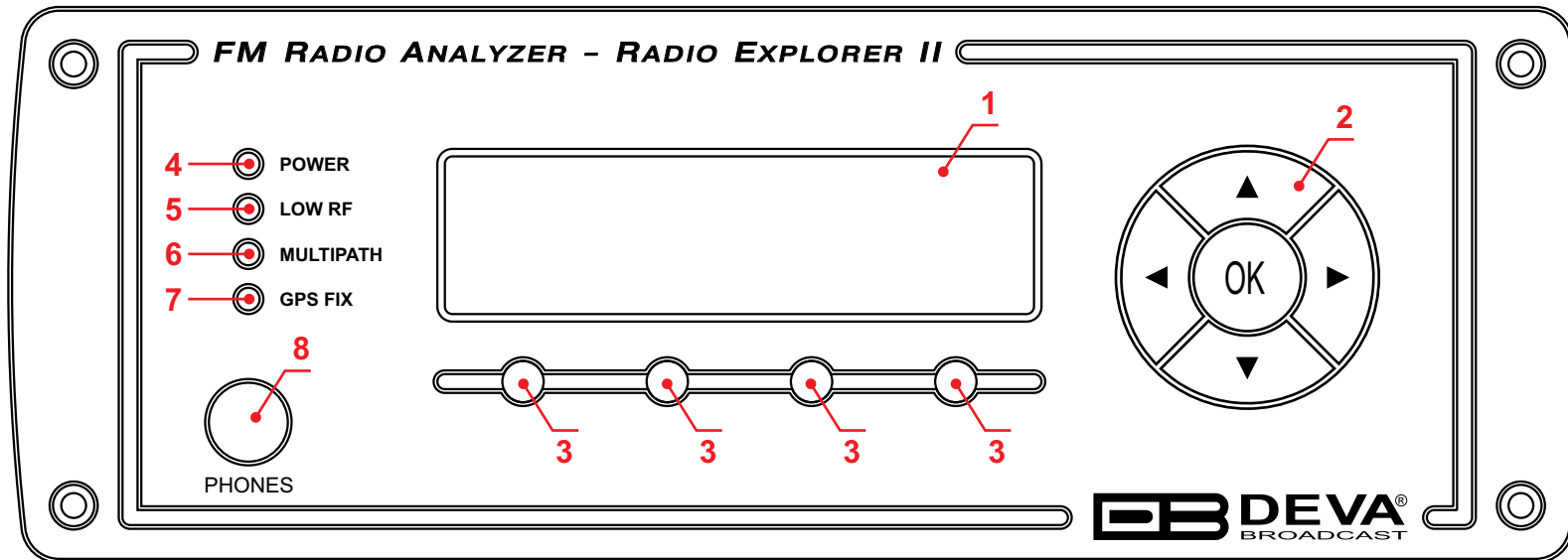

1. **High resolution OLED Graphical Display.**
2. **Navigational Buttons** – *UP* and *DOWN*, *LEFT* and *RIGHT* and *OK* buttons are used to navigate through the OLED menus selecting various functions and parameters.
3. **Soft Buttons** – will be referred to as (left-to-right) *SB1*, *SB2*, *SB3* and *SB4*.
4. **Power** indicator
5. **LOW RF** – This LED shows that the incoming RF signal of the tuned frequency is below the specified threshold.
6. **Multipath** – This LED shows that the Multipath of the tuned frequency is above the specified threshold.
7. **GPS FIX** – The LED indicator will be lit when the GPS receiver acquires a GPS fix. In case of poor GPS reception or insufficient satellites the LED will remain unlit.
8. **PHONES** – The 1/4" (6.3mm) phone jack provides the audio signal of tuned station for listening.

REAR PANEL

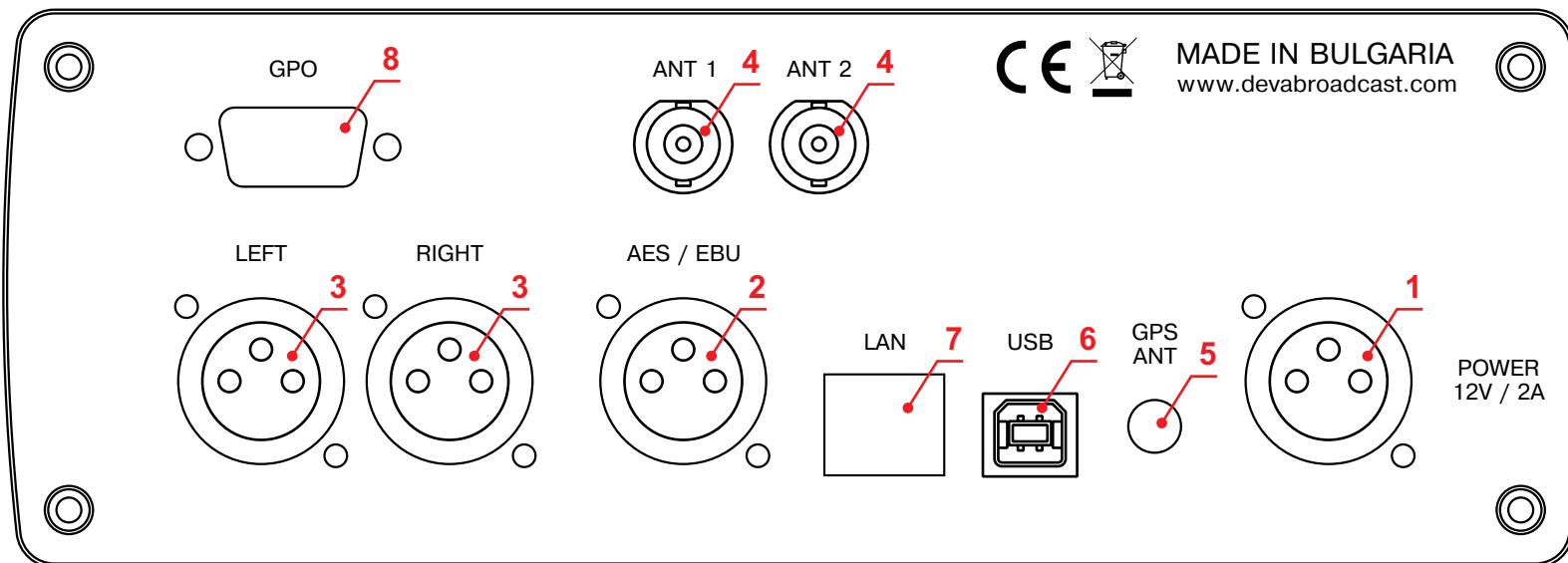

1. **POWER CONNECTOR** - DC 12V;
2. **AES/EBU OUTPUT** – XLR connector for digital audio output;
3. **PROGRAM OUTPUT** – XLR connectors for Left and Right analog audio outputs;
4. **ANTENNA INPUT** – 50 Ω BNC connector for Antenna input;
5. **GPS ANTENNA** – Consumer-standard SMA connector for GPS Antenna input;
6. **USB** – USB 2.0 Communication Port
7. **LAN** – 10/100 Mbit Ethernet port
8. **GPO** – Optoisolated, Female D-Sub 9 pins;

REAR PANEL GPO TERMINAL

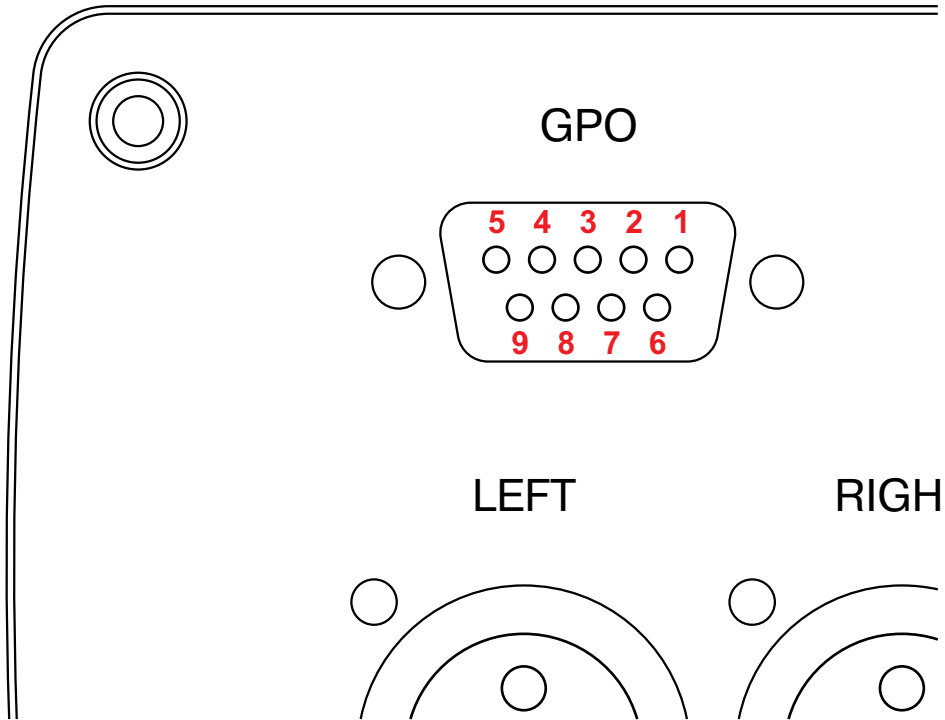

- 1 - + 12V DC
- 2 - GPO1 Collector
- 3 - GPO2 Collector
- 4 - GPO3 Collector
- 5 - GND
- 6 - GPO1 Emitter
- 7 - GPO2 Emitter
- 8 - GPO3 Emitter
- 9 - GND

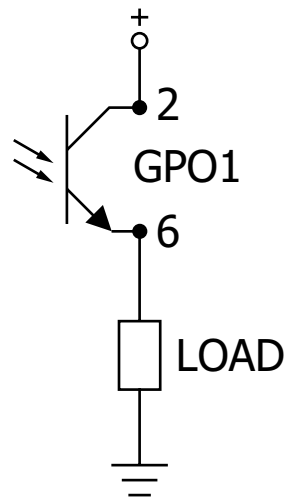
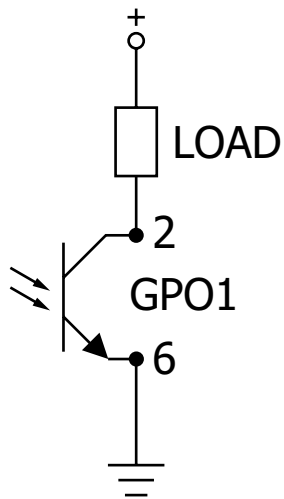

Safety Warning

ALWAYS OBSERVE THE SAFETY PRECAUTIONS.

Careful observance of the safety precautions will help prevent physical injury, damage of the equipment, and extend the equipment life.

- The servicing of electronic equipment should be performed only by qualified personnel;
- Before removing the covers the unit must be switched off and the mains cable unplugged;
- When the equipment is open, the power supply capacitors should be discharged using a suitable resistor;
- Never touch the wires or the electrical circuits;
- Use insulated tools only;
- Never touch the metal semiconductor. They might carry high voltages;
- For removing and installing electronic components, follow the recommendations for handling MOS components.
- Do not remove the factory sticker from the equipment. It contains information as regards the name, serial number and MAC address of the device.
- To join the equipment to the mains supply, use the power cord purchased with the equipment.

ATTENTION: The device has an internal Lithium battery. Do not try to re-charge this battery! In case the battery needs to be changed, please contact us for detailed instructions and information of the battery type.

Operating Recommendations

To ensure normal operation of the DEVA unit, we recommend following the instructions listed below.

- Install the unit in places with good air conditioning. The unit is designed to operate within the ambient temperature range of 10 to 50°C. The equipment rack should be ventilated in order for the device to keep its internal temperature below the maximum ambient temperatures;
- We do not recommend installation in rooms with high humidity, dusty places or other aggressive conditions;
- Although the device is intended to be installed closed to exciters or transmitters, we do recommend the device to be located away from abnormally high RF fields.
- Use only checked power supply cables. We strongly recommend the usage of shielded cables;
- Connect the DEVA unit to reliable power supply sources only. In case of unstable power supply, please use Uninterruptible Power Supply (UPS);
- Use the device only with its top cover on to avoid electromagnetic anomalies. Otherwise, this may cause problems with the normal functionality of the unit;
- To ensure normal remote operation of the unit, make sure to connect the device to a good quality Internet connection;
- For the normal operation of your DEVA device, check if the network settings past through all the required data traffic.

Unpacking and inspection

Upon receipt, the equipment should be inspected for possible shipping damages. If such are found or suspected, notify the carrier at once and contact DEVA Broadcast Ltd. The original shipping carton box and packing materials should be kept for possible reuse, in case of return for Warranty repair, for example. Shipping damages as a result of improper packing for return may invalidate the Warranty!

The packing material (plastic bags, polystyrene, nails, etc.) must never be left within reach of children, as these items are potential sources of danger.

IT IS VERY IMPORTANT that the [“Product Registration Card”](#) included in the Manual be completed accurately and returned. This will assure coverage of the terms of the Warranty and it will provide a means of trace in case of lost or stolen equipment. In addition, the user will automatically receive SERVICE OR MODIFICATION INSTRUCTIONS from DEVA Broadcast Ltd.

Mounting

RACK REQUIREMENTS 1U

The unit mounts in a standard 19-inch equipment rack and requires only 1 $\frac{3}{4}$ inches (1U) of vertical rack space. In order the painted finish around the mounting holes to be protected, the use of plastic washers is recommended.

RACK REQUIREMENTS COMPACT UNITS

Our customized 1U 19-inch rack accessory provides a professional mounting option for up to three compact size DEVA units. It is made of milled aluminum and finished in black powder coat. Two extra blanking panels and set of mounting screws are provided with each rack bracket kit.

STAND-ALONE DEVICES

DEVA's stand-alone units (Radio Explorer series, BandScanner series, DVB Explorer) do not require additional tools or installation brackets.

DEVICE CONNECTION

1. Connect the supplied FM and GPS Antennas to the BNC and SMA connector, placed on the rear panel of the device;
2. Select a suitable location for installation of the GPS antenna that would allow routing of the antenna cable to the Radio Explorer II and also would provide a clear view of the sky for a good satellite reception;
3. By using the supplied Car Cigarette Lighter adapter, connect Radio Explorer II to the Car Cigarette Lighter;
4. Configure the desired operating mode – Logger, PI/CALL Campaign or Interactive mode.

NOTE: Make sure that you have routed the cable in such a manner which would prevent pinching and/or cutting the cable by doors, windows or trunk lids, when opened or closed.

Getting Started

In order for the normal operation of the Radio Explorer II to be guaranteed, you will need fulfill the following conditions:

1. Standard Ethernet 10/100M connection;
2. Correctly assigned Network configuration and device settings.

To make sure that all the conditions are fulfilled please, follow the instructions below.

CONNECTION

1. Install the unit on its operation place;
2. Using the provided power cable, connect the unit to the power supply network;
3. Connect the antenna cable to the RF antenna input connector located on the rear panel of the device;
4. Connect the Radio Explorer II to the TCP/IP network using direct network cable;
5. **IF GSM OPTION IS SUPPORTED** - Using the connection cable provided, connect the optional GSM modem. In order for better GSM network coverage to be achieved, please select proper place for the GSM antenna.

NOTE: The GSM antenna must be installed far enough from the monitoring devices. The GSM modem radiates RF signal that may cause spurious emissions that will may interfere with the accuracy of the measurements.

NETWORK SETTINGS

After connecting the network cable the Led 'LAN' located on the rear panel must be ON or flashing. The next and most important step for configuration is the adjustment procedure of the Network Communication. The settings shown below are Default Network Settings:

DHCP	Enabled
IP	Assigned by DHCP
Mask	Assigned by DHCP
Gateway	Assigned by DHCP
DNS	Assigned by DHCP
HTTP Port	80

NETWORK DISCOVERY

This is a network setting that defines whether your computer can see (find) other computers and devices on the network and whether other computers on the network can see your computer. By default, Windows Firewall blocks network discovery but you can enable it.

1. Open Advanced sharing settings by clicking the Start button, and then on "Control Panel". In the search box, type "network", click "Network and Sharing Center", and then, in the left pane click "Change advanced sharing settings";
2. Select your current network profile;
3. Click "Turn on network discovery", and then click save changes.

NOTE: If you're prompted for an administrator password or confirmation, type the password, provide confirmation or contact your system administrator.

If you have already enabled this function on your computer Radio Explorer II will be automatically added to the Device list section. The device will be ready for usage and no additional adjustments will be required except user name and password.

NOTE: If the port is different than the default one (80), it is necessary to specify it, for example:
`http://192.168.1.2:9000`

ATTENTION: Depending on Internet Protocol Settings, the assigned IP address may not be visible outside your local network, thus the device may be accessed only within that network. Consult with your network administrator for the appropriate IP settings.

NETWORK SECURITY RECOMMENDATIONS

1. It is not recommended the Radio Explorer II to be directly connected to the Internet. This may lead to unregulated access and/or problematic operation of the device. To ensure secure connection, we recommend the device to be installed behind a router with an active firewall.
2. If remote access to the device is needed, we recommend using VPN to the router or the port of the relevant service (WEB, SNMP, Application, etc.) to be properly NAT forwarded.
3. If NAT forward is used, it is highly recommended random ports of your choice to be used. Not the standard ones (80 for WEB, 161 for SNMP, etc.).
4. Using DMZ connection is not recommended.
5. Make sure to change the standard access credentials (usernames and passwords, SNMP communities).

For detailed information as regards the recommendations listed above or need of further instructions, please contact your network administrator.

Operating Modes

The Radio Explorer II is a multifunctional, easy to use tool, designed to evaluate FM broadcast band congestion and to measure and store all important radio broadcast parameters in a Log file. This is a stand-alone solution for running surveys - no additional tools are needed. You can setup for observation up to 50 preselected channels.

The Radio Explorer II utilizes three modes of operation. We recommend choosing the proper operating mode before the observation of the signal is commenced.

LOGGER MODE

This mode is used for on-field configuration and observation. Use the front panel Navigational Menu and OLED display to configure the Radio Explorer II or to observe a specific station and GPS information. Radio Explorer II can be set to measure automatically one or multiple preselected frequencies (Up to 50).

PI/CALL CAMPAIGN MODE

Up to 10 stations can be chosen. Radio Explorer II will automatically detect the used frequency. While the campaign is running, the chosen stations will be monitored; Radio Explorer II will automatically switch over between the variable frequencies during movement - just as the car radio of your listeners.

This mode is used for running Campaign Surveys. It is necessary that the Campaign Channels and supplemental Radio Explorer II settings be pre-configured before starting a campaign. No additional adjustments or settings will be required, except for the occasion when the campaign is to be stopped.

INTERACTIVE MODE

This is the recommended operating mode for stationary FM observation which allows the user to perform a signal evaluation by changing the desired frequencies and monitoring the received data.

Apart from allowing management of Radio Explorer II via the Front panel Navigational Menu, WEB Interface and Software, this mode is perfect for Band scan campaigns.

Navigation through OLED Menu

Radio Explorer II can be operated in three methods: through the Front panel navigational menu, DEVA Device Manager Software or via a standard WEB Browser.

NAVIGATIONAL BUTTONS

UP-DOWN, *LEFT-RIGHT* and *OK* buttons, like the Soft Buttons, are used to navigate through the menus, for selecting various functions and parameters of Radio Explorer II. The Main Menu structure has an up-and-down basis, expanded with left-to-right branches.

SOFT BUTTONS

Used for navigation through the menus, quick access to the parameters, modes, functions and to alter their values. The Soft Buttons indicators are placed on the bottom side of the OLED display. Depending on the currently selected menu context, the indicators change their function. The Soft Buttons will be referred to as (left-to-right) *SB1*, *SB2*, *SB3* and *SB4*.

The purpose of all Soft Button corresponds to the selected menu page. Most pages have the same or similar functional areas. The corresponding functions as Function, Menu Page, Parameter to be changed, etc., linked with the Soft buttons will appear as labels above them.

For example:

Cancel	– Discard changes being made;
Home	– HOME PAGE will be selected;
Back	– Return to previous page;
Low ON	– Alternating low threshold button;

NOTE: On some pages, the *Header* and *Soft button* area will disappear in order to expose the content underneath.

OLED DISPLAY

Radio Explorer II has an easy to read, high-resolution OLED graphical display that visualizes all measurements of the received signal and settings. Upon switching it on, the Company Logo and model of the device will be displayed. After a few seconds the Start-up screen will disappear, replaced by the Main Screen. This is the starting point of the navigation process.

The Radio Explorer II's OLED display has three function areas: Header, Soft Buttons and Main Screen Working area.



OLED display with function areas

Header area

The Header is located on the left part of the screen. The header content is determined according to the work area context and may include the following functions:

99.90 FM – Frequency Indicator, showing the currently selected frequency, in MHz, is located in the upper left corner;

IN ANT 1 – Represents the currently selected active Antenna Input.

ANT 1 – Antenna 1 Input is selected. *ANT 2* – Antenna 2 Input is selected;

ATT -10 – Attenuator Indicator – represents the currently selected position of the active Antenna Input. Attenuator's position can be set manually or automatically by the device;

STEREO 50µ – Indicator for Stereophonic Information-contains information about the received signal and currently selected de-emphasis time constant;

RDS – Indicator for RDS presence of information contained in the received signal;

VERONIKA – Decoded PS information from RDS signal;

RF  – Indicator showing the signal level at selected antenna input;

VOL  – Indicator showing the phones audio volume;

IF BW  – Indicator showing the currently selected IF band-pass filter bandwidth.

Main Screen working area

The Main part of the OLED Screen is where the data changes dynamically, depending on the selected operating mode. The Menu Screen (shown below) appears upon pressing of the “OK” Navigational Button. The Radio Explorer II's Menu Page contains selectable icons and software buttons for selecting modes and functions. Pressing *Left* and *Right* arrow buttons will change the icon selection on the Menu Page. The current selection is shown as a rectangle focus frame around the icon. Pressing “OK” button will navigate to the corresponding page.

Operating Modes and Pages

HOME PAGE

Upon power-up and boot process the Home page will be displayed. Radio Explorer II provides you with different types of visualization of the Home page which are available at: ***Settings> Device> Home Screen***

NOTE: Transition to Home page could be made from any page where Soft Buttons with function 'Home' is available.

The default home screen contains a Header area, the most important flags and attributes of the decoded RDS signal (if present) and the currently selected frequency indicator.

BANDSCAN PAGE

Select Bandscan icon from the Menu page and press “OK” to enter it.



The last Bandscan data will be displayed.



Empty grid will be displayed if no bandscan data is available at the moment.

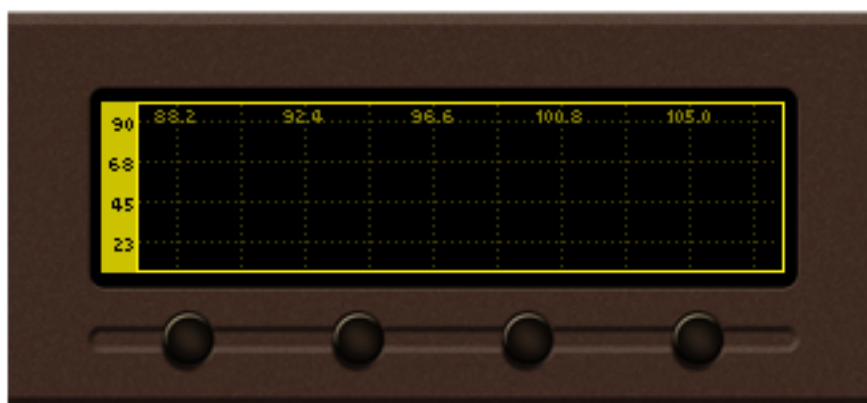

To ensure better reading of the data plot, the Header area and the Soft Buttons labels will be hidden automatically a short time after the soft button is released. Pressing a button will display the function labels again.

There are three control states in Bandscan page – Span control, Marker control and Parameter control. The states can be identified by the labels of the Soft buttons. If the labels appear as shown on the picture below, the page is in the Marker control state.

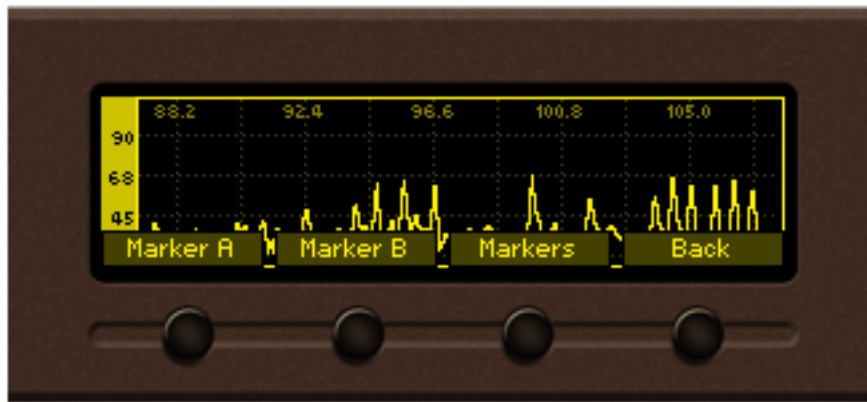

For example: When the following menu is selected pressing *SB3* will change the screen from Marker to Span control and vice-versa. All Soft button labels will change according to the sub-menu. The control state of the page will change upon every *SB3* pressing. Pressing the *OK* button either in Marker or Span control state will make the transition to Parameter control state. The screen will be visible until the *OK* button is pressed again or the timeout of 2 seconds elapses.

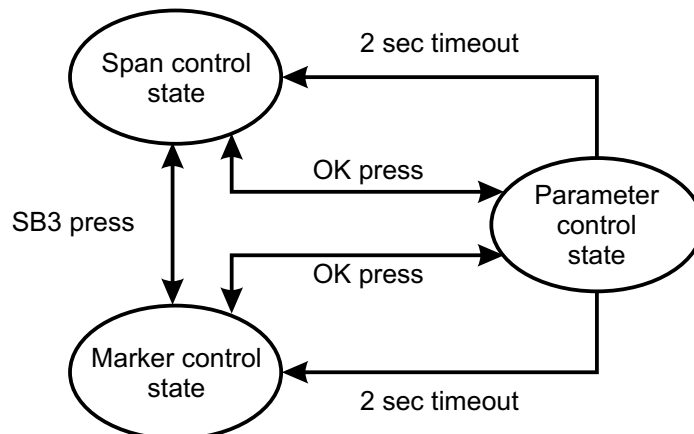

Span control state

SB1, *SB2* and *Arrow buttons* control the Span of the data plot. Depending on the Span control state the Soft buttons have different usage.

X Span – (*SB1*) cycles through available span values for the X axis of the data plot. The possible values vary between 3 and 21 MHz in 1 MHz increments. Once a key is pressed the next span value will be selected and displayed on the screen.

NOTE: Changing X span may also change the center frequency, in order to keep the data plot in bounds.

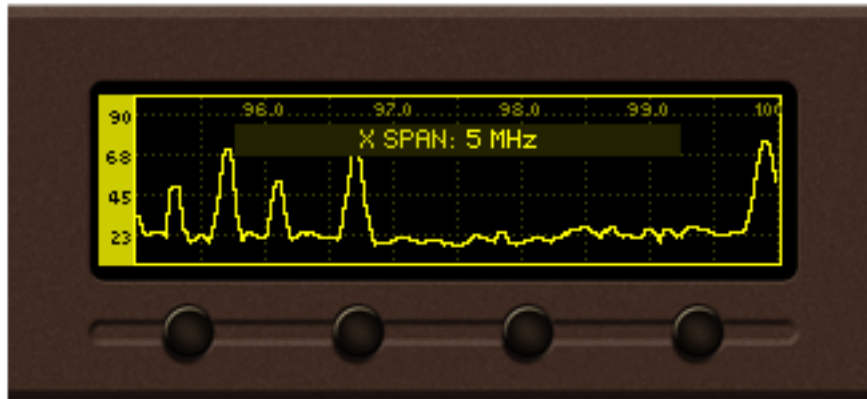

5MHz X span is selected

Y Span – (*SB1*) cycles through available span values for Y axis of the data plot. The possible values are 30, 60, 90, and 120 dB μ V. Note that in order to keep the data plot in bounds changing Y span may also change the Y reference. When the button is pressed the new value will be selected and displayed on the screen.



120 dBµV Y span is selected

Left / Right Buttons – change the center frequency of the data plot on 500 kHz increments. The center frequency permitted values depend on the currently selected X span. The selected center frequency value is briefly displayed on the screen.

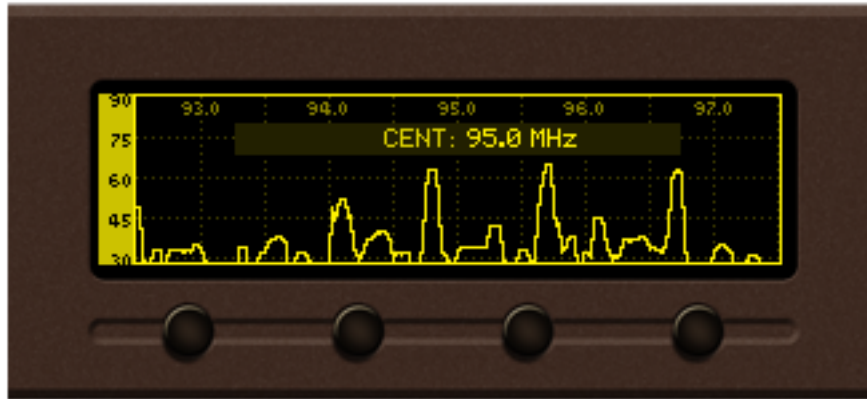

95 MHz center frequency is selected

Up / Down Buttons – changes Y axis reference (the value for the bottom of the Y scale). Permitted values vary from -20dBμV to 110dBμV in 10dBμV increments. The upper limit of the Y reference depends on the currently selected Y span. Upon selection, the Y reference is briefly displayed on the screen.

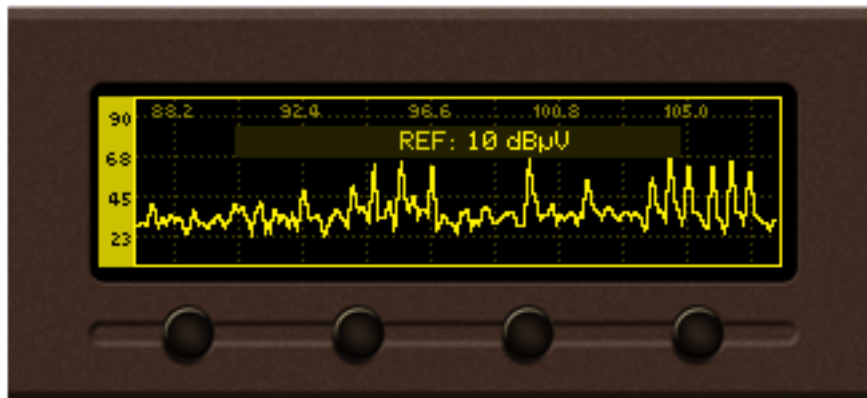

10 dBμV reference is selected

Marker control state

Two markers, named “A” and “B” are available on Bandscan page. *SB1*, *SB2*, *Left* and *Right* buttons control the visibility and position of the Markers.

Buttons *SB1* / *SB2* control Marker A / Marker B appearance. According to your needs the markers can be:

- Hidden – marker is not visible;
- Shown – marker is visible but not selected;
- Selected – marker is visible and selected.

When markers “A” and/or “B” are visible (shown or selected) a readout about X and Y axes will appear on the left side of the data plot. If both markers are visible, the differential “Marker B minus Marker A” value will be displayed at the bottom left of the screen. The selected marker is represented as highlighted, dashed line; the marker’s readout is also highlighted. Only one marker at a time can be selected. If only one of the markers is visible, it will be always selected.

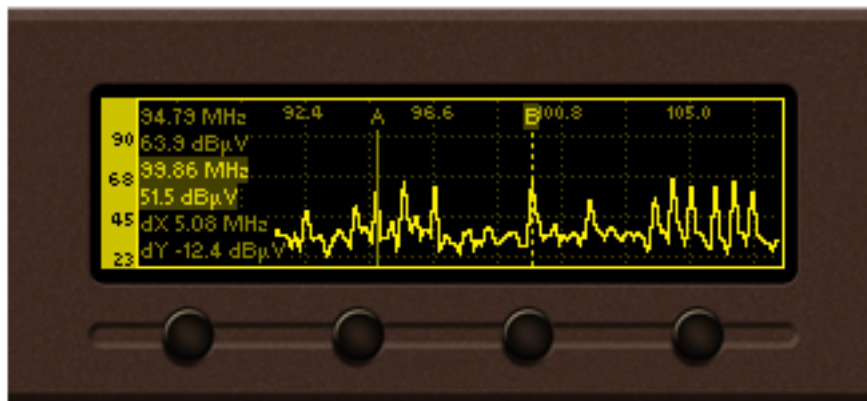

Marker A is shown, Marker B is selected

Following is a diagram explaining the transition between these states:

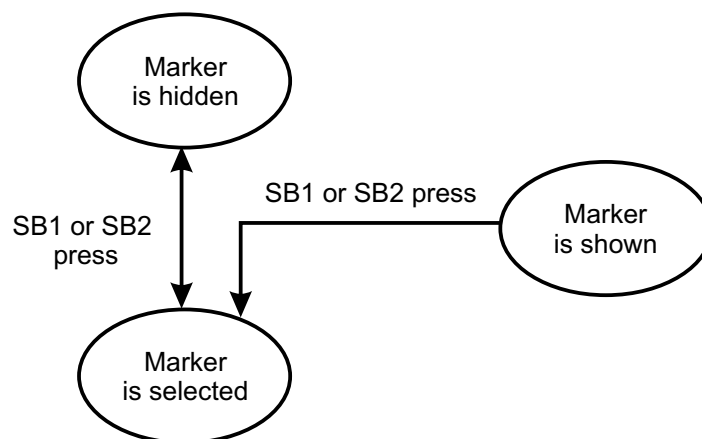

Left / Right Buttons – move the selected marker to the left or right with one screen pixel increment.

NOTE: The step resolution of marker movement depends from the selected X span.

Up / Down Buttons – are used to change the Y reference like in the Span control state.

Parameter control state

The parameter control state allows specific parameters to be set before starting the bandscan.

OK – show/hide Parameter control

Left / Right Buttons – cycle through the available parameters.

Up / Down Buttons – change the value of the selected parameter.

The name and value of the selected parameter appear briefly on the data plot.

NOTE: Parameter control state will automatically disappear from the screen if no button is pressed for 2 seconds.

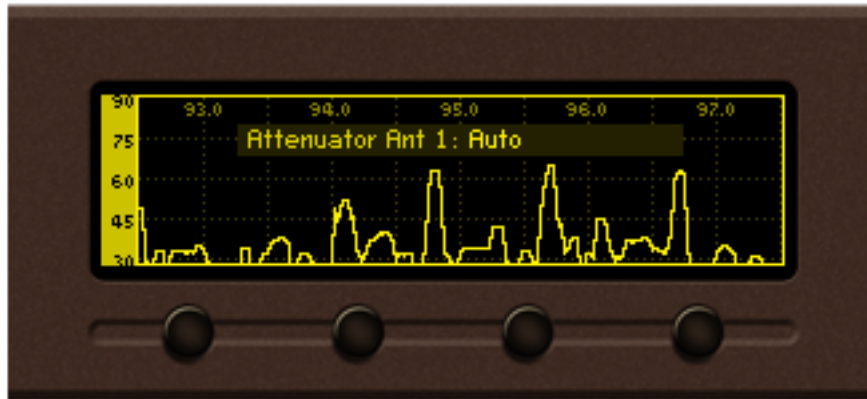

Bandscan page parameters

Bandscan: Start / Stop – Used for starting/stopping of the bandscan process. Information about the progress will be displayed on the right bottom corner of the data plot. Upon completion, the Bandscan parameter value will be automatically set to “Stop”.

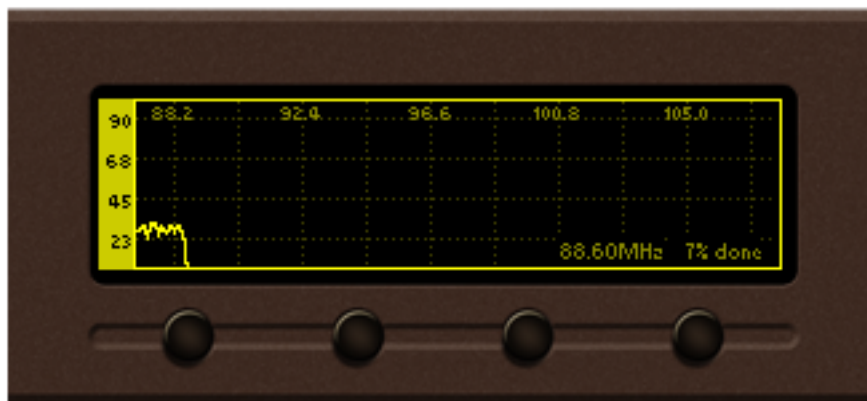

Bandscan in progress

Running bandscan can be stopped manually by setting the Bandscan parameter value to “Stop”.

Start Frequency: – set the start frequency of the bandscan.

End Frequency: – set the end frequency of the bandscan.

Step: 10, 20, 50 or 100 kHz – set the step increments of the band. Small steps lead to higher resolution but slower bandscan;

RF Input: Antenna 1/Antenna 2 – select the antenna input to be used during bandscan;

Pressing *SB4* in Bandscan page will lead back to the previous page.

NOTE: Leaving the page will not stop the bandscan process. The process will continue until it is finished or the Bandscan parameter value is set to “Stop”.

FFT PAGE

Select the Fast Fourier Transform (FFT) icon from Menu page and press the *OK* button to enter the menu. As the name indicates, spectral components of the selected signal are determined on the base of FFT.



The FFT is the Fourier Transform of a block of time data samples. It represents the frequency decomposition of the time signal.

Upon switching on the data from the last FFT source signal will be seen on the screen of Radio Explorer II.

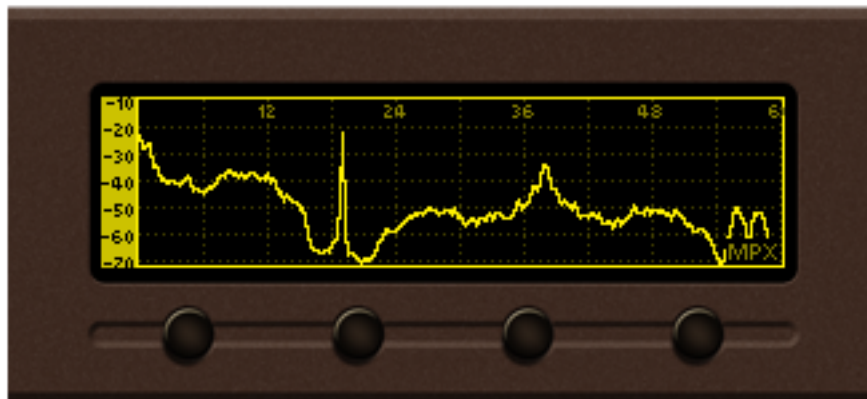

FFT with MPX selected as signal source

The control states of FFT page are identical to the control states of Bandscan page (see [“Span control state” on page 30](#), [“Marker control state” on page 32](#), [“Parameter control state” on page 33](#)). The X Span, Y Span, Center Frequency, Y Reference and Markers can be changed likewise.

Parameter Control States:

Source – The signal source to be calculated and visualized is chosen from the Signal section placed on the right bottom corner of the data plot. The sources to be chosen from are as follows - RF, MPX, Left and Right.

RF Input – Select the active antenna input.

Average – indicates buffer numbers taken included in the calculation and obtaining of the average signal. The possible values of the parameter are: 1 (no average), 5, 10, 20, 50, Infinite.

Frequency – sets/indicates the tuned frequency.

Window – sets the Window Function to be used in order for the FFT to be calculated. The FFT based measurements are subject to errors from an effect known as spectral leakage, which occurs when the FFT is computed from of uninterrupted data block. This problem could be minimized by applying the appropriate windowing function. Depending on the specific application, the appropriate window function should be applied. Errors may be introduced in the FFT amplitude, frequency or overall shape of the spectrum if the windowing is not correctly applied.

The available windows and their features are given below. This table can be used to choose the best windowing function for each application.

Window	Best type for these Signal Types	Frequency Resolution	Spectral Leakage	Amplitude Accuracy
Rectangle	Transient & Synchronous Sampling	Best	Poor	Poor
Barlett	Random	Good	Fair	Fair
Blackman	Random or mixed	Poor	Best	Good
Hamming	Random	Good	Fair	Fair
Von Hann	Random	Good	Good	Fair
Flat-top	Sinusoids	Poor	Good	Best

SCOPE PAGE

Select Scope icon from Menu page and press the *OK* button - transition to the Scope page will be made. Scope mode is used for visualizing of the most important signals, participating in the process of demodulating and stereo decoding. This mode represents the observed signal change over time. For better reading of the visualized signals, the Header and Soft button labels will be hidden.



Upon switching on the data from the last selected Scope source signal will be visualized on the screen of Radio Explorer II.



Scope with RDS selected as signal source

The appearance and control states of the Scope page are identical to the control states of the Bandscan page (see [“Span control state” on page 30](#), [“Marker control state” on page 32](#), [“Parameter control state” on page 33](#)). The X Span, Y Span, Center Frequency, Y Reference and Markers can be changed likewise.

Parameters available:

Source – Determines the source signal for the scope plot. The sources to be chosen from are as follows - RF, MPX, Left, Right, Pilot, RDS, Sub and Main. The selected signal is indicated at the right bottom corner of the data plot.

RF Input – Select the active antenna input.

Frequency – sets/indicates the tuned frequency.

STEREO PAGE

Select the Stereo icon from the Menu page and press the OK button - transition to the Measure Stereo page will be made.



The graphical representation of the phase relations between the Left and Right audio channels is illustrated below. This graphic is used to assess the mono compatibility of the audio material as well as visualizing the stereo image or balance. The Experienced users can easily detect the differences between mono signals, “pan-pot” stereo and true stereo signals. The audio levels for both left and right channels are given in kHz.



Button assignments:

OK – Leads back to the Main menu.

Left/Right – Sets the current frequency.

Up/Down – Increases/decreases the Phones audio level.

SBI-SB4 – Fast Presets.

GRAPHS PAGE

Select the Stereo icon from the Menu page and press the *OK* button to enter the menu.

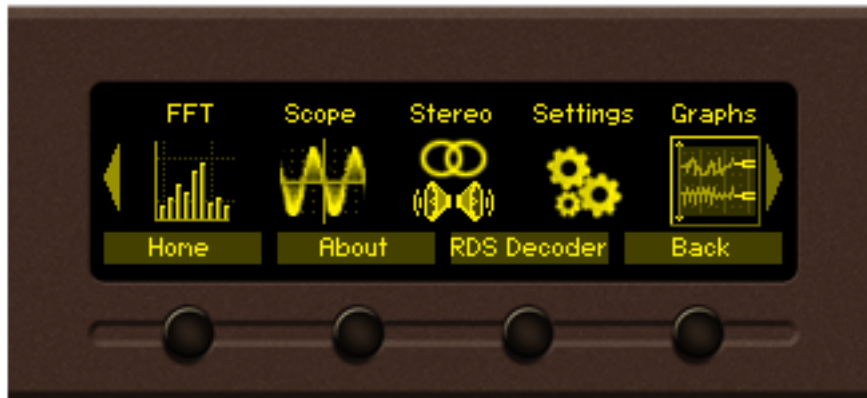

Graph page represents the value of a measured signal over time. The X axis of the data plot area represents the elapsed time in seconds. The New peak value sample is added to the data graph every 125ms (20 seconds for the MPX power). Up to 20 seconds of measurement history is available for each signal. The newest sample is on the right side of the graph. The current signal name and measurement unit are displayed in the top left corner of the data plot.

A bar graph indicator, placed on the right portion of the screen, is used to display the instantaneous value of the selected signal. The low, average and high values of the measured signal are represented in shaded color.

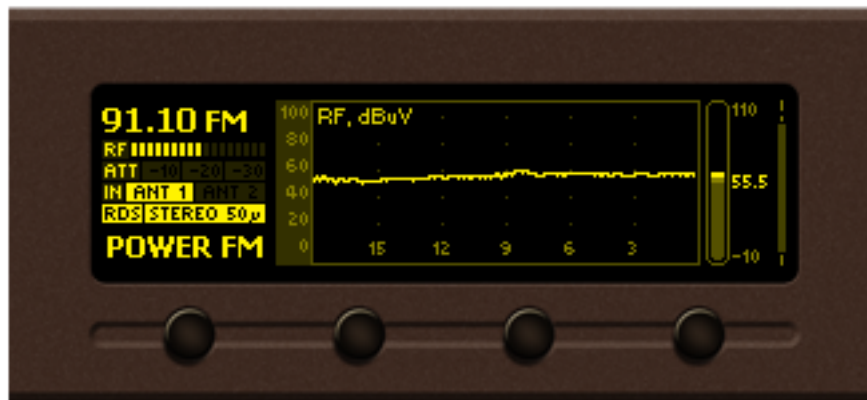

Graph history of RF level



Graph history of MPX Power – the time span is in minutes

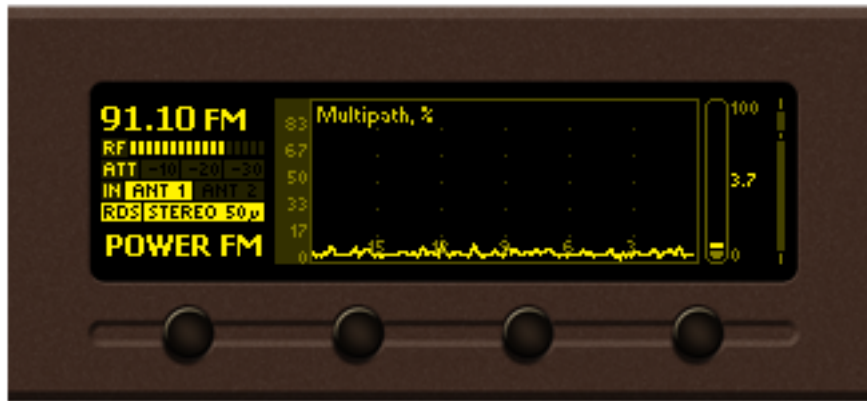

Graph History of Multipath

Button Assignment:

SB1 to *SB4* – lead to different screens of the menu

OK – leads back to Main menu page.

Up/Down – Change the currently displayed signal. The following signals can be selected:

- RF Level – from -10 to 110 in dB μ V;
- Multipath level from 0 to 50 in % (percent);
- Total MPX deviation from 0 to 125 in kHz;
- MPX power from -12 to 12 in dB. Due to the 20 second integration of the MPX power calculation the time span for MPX power graph is in minutes. Up to 48 minutes of MPX power history is available;
- Pilot level from 0 to 15 in kHz;
- RDS level from 0 to 15 in kHz;
- Left audio level from -60 to 10 in dB;
- Right audio level from -60 to 10 in dB;
- Frequency offset of the RF carrier from -50 to 50 in kHz;
- Temperature in the device from -10 to 90°C.

LEVELS PAGE

Select the Levels icon from the Menu page and press the *OK* button to enter the menu.



The Levels page shows a bar graph representation of the signals measured by Radio Explorer II. The parameters are divided into groups. Each bar graph displays the low, average and high values of the signal. The number, placed below the bar graph - in the middle, represents the average value. The shaded color number, placed on the left and right bottom edges, denotes the measurement range of the signal. Measurement units and name of the signal are written above the corresponding bar graph.



Group 1. RF carrier related parameters

The **RF level** at the selected antenna input is measured in dB μ V. The RF attenuation is included in the level calculation.

The **Frequency offset** of the RF carrier is measured in kHz. This signal measures the misalignment between the modulation and demodulation frequency. As the misalignment is expected to be small, a large offset will indicate disturbance (for example adjacent channel breakthrough).

The **Frequency offset** is measured with better accuracy if there is no modulation of the carrier. The usable range depends on the selected IF filter bandwidth. For better results, we recommend the IF filter bandwidth to be manually set to 153 kHz.

The Level of **multipath** reception is measured in percentages. The multipath detector measures the amplitude fluctuations of the signal. The FM signal is broadcast with a fixed level; therefore the level fluctuations will indicate degraded signal quality. At multipath conditions, large level fluctuations can be measured. Install the antenna at the reception point with the lowest multipath level in order to achieve better re-broadcast.

IF Bandwidth – Shows the currently IF filter bandwidth.



Group 2. Stereo multiplex related parameters

MPX Positive and MPX Negative – These bar graphs represent the positive and negative deviation component of the MPX signal. In wide-band FM, used in wireless broadcasting, the instantaneous frequency varies above and below the frequency of the carrier with no modulation. The carrier frequency shifts in one direction when the instantaneous input wave is with positive polarity and vice-versa - when the instantaneous input wave is with negative polarity, the carrier frequency shifts in the opposite direction. At every instant in time, the extent of carrier-frequency shift (the deviation) is directly proportional to the extent to which the signal amplitude is positive or negative.

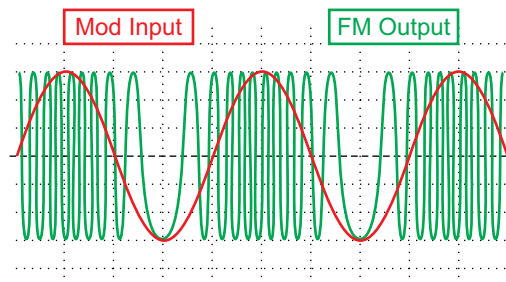

Pilot – Represents the deviation caused by Pilot tone injection. Our practice shows that the pilot deviation should be about 10% of the total deviation of the RF carrier.

RDS – Represents the deviation caused by RDS subcarrier. Our practice shows that the RDS deviation should be about 5% of the total deviation of the RF carrier.



Group 3. Audio related levels



Group 4. Reception quality related levels

Ultrasonic Noise bar graph – Indicates the MPX signal amplitude in the approximate bandwidth of 80 kHz – 150 kHz.

Stereo Blend bar graph – In stereo signals, the difference (L-R) component of the MPX signal is more susceptible to disturbances than the sum (L+R) signal. Therefore, the separation of the left and right audio channels can be decreased in order the audibility of the disturbance to be reduced. This channel separation reduction is called “stereo blending”. A value of 100% indicates that no reduction is applied. The level of stereo blending depends on the following input signals: RF Signal Level, Multipath, Ultrasonic Noise and Pilot tone deviation.

High Cut bar graph – Audio disturbance effect is generally present in the high frequencies. Therefore, a means of reducing the effect of disturbances is to filter the high frequencies. The audio bandwidth reduction is called “high cut”. A value of 100% indicates that no “high cut” is applied. The applied High Cut level depends on the following input signals: RF Signal Level, Multipath and Ultrasonic Noise.

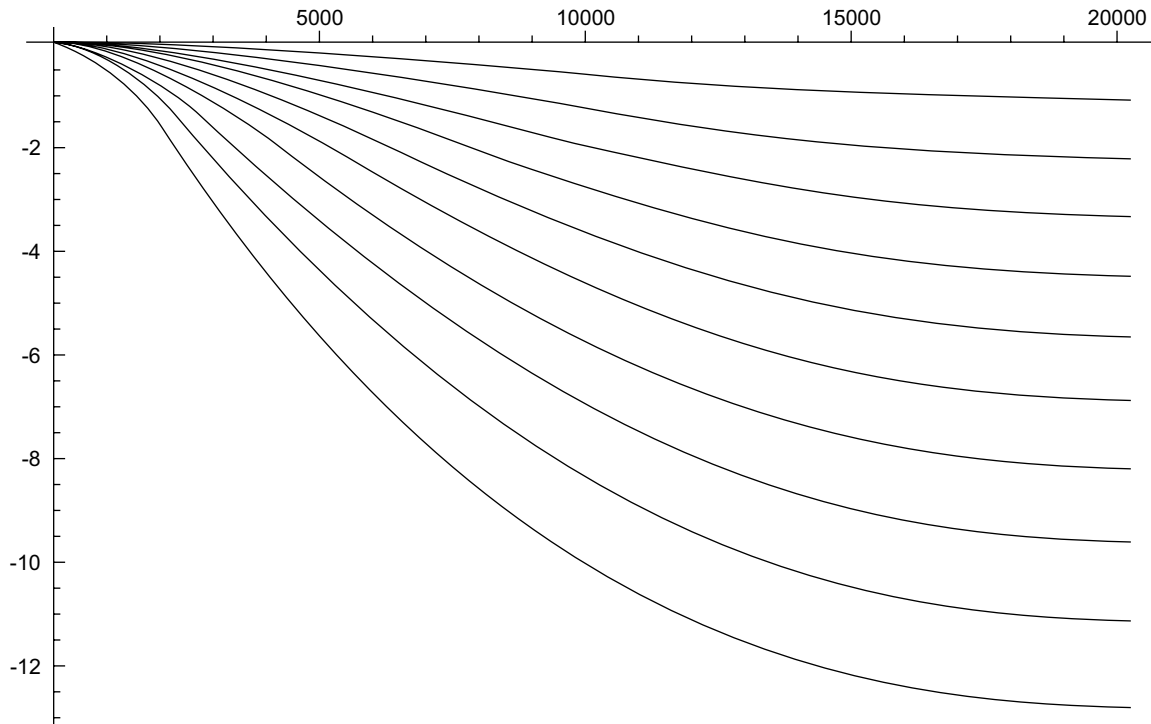

Response of the FM High Cut function for several reduction values

Soft Mute bar graph - If a disturbance is present in the received signal, the perceived effect can be reduced by attenuating the audio signal. The reduction of audio volume is called “soft mute”. A value of 0% indicates that no “soft mute” is applied. Soft Mute depends on the following input signals: RF Signal Level, Multipath and Ultrasonic Noise.

Buttons assignment:

OK – leads to Main menu page.

Up/Down – Changes the currently displayed bar graph group 1 – 4.

SBI-SB4 – lead to different screens of the menu

STATUS PAGE

Select the Status icon from the Menu page and press the *OK* button to enter the menu.

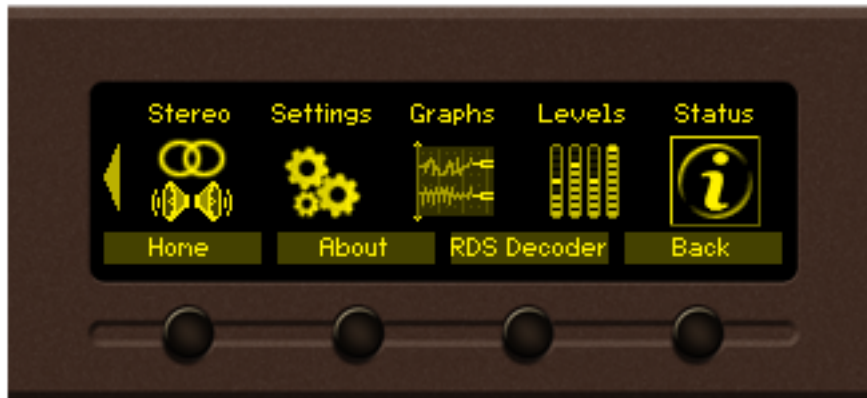

The Status Page contains all basic information regarding the device:

Status > Device

This section contains information about the Model, Serial No., Firmware version used, Calibration date and Available Storage capacity.



Status > IP Address

This Section contains information regarding the IP, Network Mask, Gateway, Primary and Secondary DNS.



Status > GPS

Contains information of the device's current location and GPS Signal in Range.



Loc: The current location of the device - Longitude and Latitude in degrees.

UTC: Current GPS date and time.

Fix: The current condition of the GPS fix and type.

Sats used: The number of satellites used out from the satellites in view.

SETTINGS PAGE

Enter the Main Menu page, select Settings Icon and press *OK*.



The Settings menu is organized into a hierarchical tree menu and all similar parameters are grouped into sections (branches). The structure of the menu is shown below.



“Tuner” section (branch) of the root Settings menu



“Frequency” parameter from “Tuner” branch

Settings Menu screen structure

Settings menu title

Settings>Tuner – shows the path to the currently selected menu. Note that the parameter should be included in the settings menu title.

For example: **Settings > Communication > Application - Port** is different from **Settings > Communication > HTTP - Port**.

Navigation area



– selection of branches / parameters is made in this area. The selected item is highlighted. All parameters are listed on the left side of the navigational area. All parameter values are displayed on the right side against the parameter name. Since branches have no values associated, tree dots are shown instead. This indicates that a transition to a sub-menu is available.

Front panel buttons usage:

OK – Depending on the selected menu element can perform different actions:

- Menu branch – transition to selected sub-menu will be made;
- Menu parameter – when a value of a parameter is highlighted pressing *OK* will switch to edit mode;
- Menu complex parameter (such as Alarm) – the parameter editor screen will be shown.

Up/Down – If edit mode is active, the value of the selected parameter will be changed. Otherwise, are used for navigation through the menu;

Left/Right – Change the selection when the parameter value is in edit mode;

SB4 – Return one level up or cancel edit mode.

There are several parameter types available. The way of editing depends of the parameter type. Every parameter type has its own editing rules.

Numerical parameter (INT). Represents numerical value.

Example: **Frequency 98.05 MHz** The value frequency can be changed in the range of 87.1-108 MHz (CCIR), 65-74 MHz (OIRT), 76-95 MHz (Japan) and step of 10, 20, 50 or 100 kHz.

INT mode, front panel buttons usage:

Up/Down – Change the value of the parameter with one step. The step value may vary depending on the selected parameter. The value always stays in permitted parameter range;

OK – Accept the changed value and exit edit mode;

SB4 will discard the value and cancel edit mode.

Enumerated parameter (ENUM, TZONE). Represent the selection of a value among set of predefined enumerated values.

Example: **Attenuator Ant 1 Auto** The value Attenuator can be selected from “Auto”, “OFF”, “-10dB”, “-20dB” and “-30dB”.

ENUM mode, front panel buttons usage:

Up/Down – Cycle through the possible values;

OK – Accept the changed value and exit edit mode;

SB4 will discard the value and cancel edit mode.

IP address (IP). Represents an IPv4 address.

Example: **Primary DNS 192.168.001.001**, **Network Mask 255.255.255.000**

IP mode, front panel buttons usage:

Left/Right – Select edit marker position;

Up/Down – Cycle through the possible values;

OK – Accept the changed value and exit edit mode;

SB4 – Discards all changes and cancels edit mode.

IP port (PORT). Represents TCP or UDP port.

Example: **Manager Port 162**

IP PORT mode, front panel buttons usage:

Refer to “IP mode, front panel buttons usage”.

RDS Program Identification (PI). Represents RDS Program Identification.

RDS PI edit mode, front panel buttons usage:

Refer to “IP mode, front panel buttons usage”.

Date (DATE). Represent date from the calendar.

Example: **Date** 15-Jun-2012

DATE mode, front panel buttons usage:

Left/Right – Selects previous/next segment from the date;

Up/Down – Cycle through the possible values;

OK – Accept the changed value and exit edit mode;

SB4 – Discards all changes and cancels edit mode.

Time (TIME). Represent time information.

Example: **Time** 02:00:00

TIME mode, front panel buttons usage:

Refer to “DATE mode, front panel buttons usage”.

Timer (TIMER). Represents relative time interval.

Example: **Screen Saver** 2 min

TIMER mode, front panel buttons usage:

Up/Down – Increments/decrements value with one step. The unit value will be changed automatically from seconds to minutes and vice-versa;

OK – Accept the changed value and exit edit mode;

SB4 – Discards all changes and cancels edit mode.

String (STR). Represents string.

Example: **User Name** user

STR mode, front panel buttons usage:

Left/Right – Select edit marker position. If *Right* button is pressed when the marker is at the last character, a space character will be added at the end of the string. When the *Left* button is pressed all trailing spaces will be removed;

Up/Down – Cycle through the possible values. Depending on the string context there is a limitation in the permitted char set. For example phone number string can contain only “1234567890+” and blank space characters;

OK – Accept the changed value and exit edit mode. Some Strings must pass a validation check. If the validation fails, a message box will appear. Press *OK* to dismiss the message. Note that edit mode will not be left. For example:



OK press



OK press



SB2 – Inserts blank space before the selected character:

User Name **us r** – before;

User Name **us|er** – after.

SB3 – Deletes the selected character:

User Name **us r** – before;

User Name **us|** – after.

SB4 – Discards all changes and cancels edit mode.

HOW TO START A PI OR LOGGER CAMPAIGN USING THE FRONT PANEL MENU?

IMPORTANT: Prior to the set-up procedure:

- You will have to note that the campaigns (PI and Logger) cannot be performed simultaneously. The PI campaign is with higher priority, thus in order for a Logger mode campaign to be performed you will have to make sure that the PI Campaign is disabled.
- If the channels that you would like to monitor in RDS PI / RBDS CALL mode do not have PI/CALL signs based on which the monitoring is made in this mode, we recommend you to use the Logger mode.

In order to set up a campaign via the front panel menu, the following steps should be completed:

1. Press the [OK] button to enter the *Main Menu*> *Settings* and again press [OK];
2. Then select *PI Campaign*> *PI Channel 1*;
3. Specify name of the PI and for 'Active' - select Antenna 1;
4. Change the Acquisition time as per your preferences. We recommend setting it to 10 seconds;
5. Steps from 2 to 4 should be applied for each of the channels to be monitored. Once all PI Channels are set you can proceed to the last step
6. Go to *Settings*> *PI Campaign*> *PI Campaign Mode* and as a value set 10 seconds. In order for a campaign to be commenced the device should be inactive for the specified time.

The settings for Logger mode are identical with the PI Campaign settings, except for the menu path which is *Main Menu*> *Settings*> *Logger*> ...

NOTE: The front panel inactivity time should expire prior the PI Campaign countdown to begin.

Restore factory defaults

In the very rare case when an emergency recovery is needed, Radio Explorer II can Restore Factory Defaults from its non-volatile memory. The Factory default settings could be applied through the Front panel Navigational Menu, the WEB Interface or DEVA Device Manager Software.

In order to apply the Factory defaults through the Front panel navigational menu go to: **Settings> Device> Factory defaults> Apply to**. Radio Explorer II utilizes three types of Factory Defaults:

1. All – all applied settings will be restored to the factory defaults;
2. Retain Comm. – all settings except for the Network settings (IP Address), the WEB Server and DEVA Device Manager Software settings will be restored to the factory defaults;
3. Channels – all settings applied to the channels of the Logger and the PI/CALL campaign will be restored to the factory defaults.

WEB Interface

Radio Explorer II is also controlled through a built-in web server. A standard web browser can be used to monitor its status or to make some adjustments.

There are two options for access to the WEB Interface of Radio Explorer II: through manual identification of the IP address of the device, and alternatively through the Network discovery option.

MANUAL IP ADDRESS IDENTIFICATION

Connect the device to a local network or to the Internet by the applied LAN cable. Through the Front panel navigational menu pressing the “OK” button you will enable you to enter the device main menu.

Using the “Right” navigational button find the “Status” section located at the end of the Menu.



Press the “OK” Button to enter the “Status Section”. Via the Front panel navigational menu press the “DOWN” button.



This operation will visualize the screen containing information about the IP Address of the device.



Open a new WEB Browser and enter the device IP address in the address field then press “Enter”.

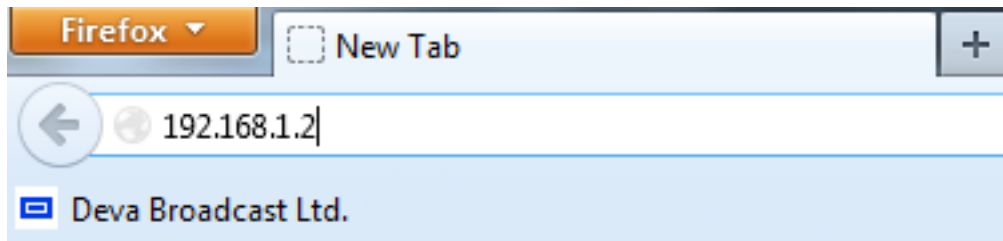

NOTE: Due to the inability of some WEB Browsers to read the IP address format displayed on the screen of the device, the numbers included in the IP Address must be written without the leading zeros. For example: 192.168.020.095 must be written as 192.168.20.95

A window that requires username and password will appear.

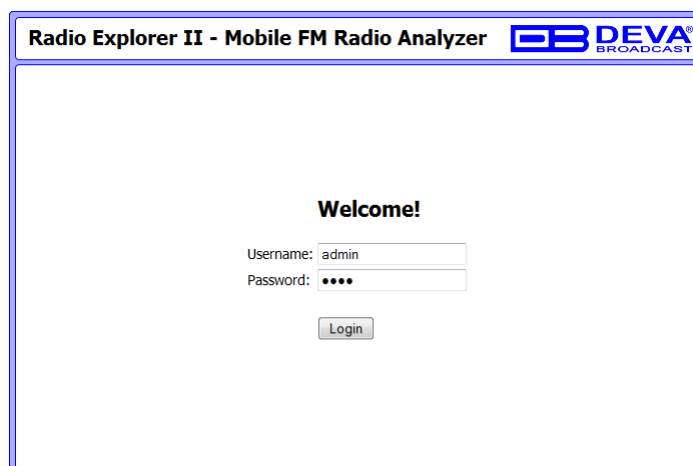

NETWORK DISCOVERY

This is a network setting that defines whether your computer can see (find) other computers and devices on the network and whether other computers on the network can see your computer. By default, Windows Firewall blocks network discovery but you can enable it.

1. Open Advanced sharing settings by clicking the Start button, and then on “Control Panel”. In the search box, type “network”, click “Network and Sharing Center”, and then, in the left pane click “Change advanced sharing settings”;
2. Select your current network profile;
3. Click Turn on network discovery, and then click save changes.

NOTE: If you’re prompted for an administrator password or confirmation, type the password, provide confirmation or contact your system administrator.

If you have already enabled this function on your computer Radio Explorer II will be automatically added to the Device list section. The device will be ready for usage and no additional adjustments will be required except *user name* and *password*.

ACCESS

Radio Explorer II provides you with a protected access to the device settings. You can choose between two types of log in:

1. As an ADMINISTRATOR – it will give you full control over the settings (username: *admin*, password: *pass*);
2. As a USER – this type of log-in will allow you to monitor the device and to choose different stations without applying settings (username: *user*, password: *pass*).

In order to make the necessary adjustments to the device, please log in as an ADMINISTRATOR.

MAIN PAGE

A successful log in the Control Window will look like this:

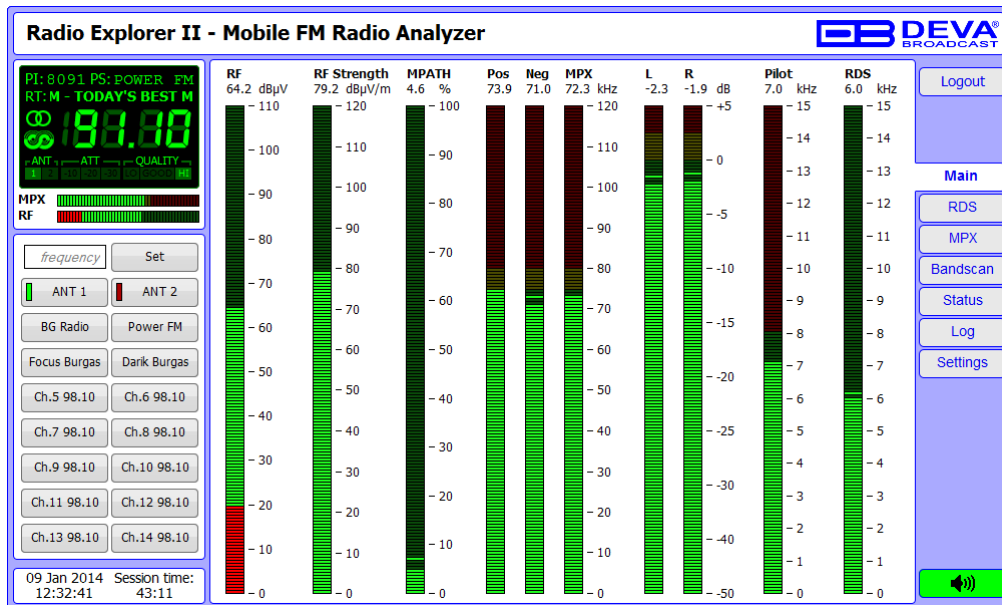

The Main Screen of the WEB Interface shows all mandatory parameters represented as LED readings.

You can choose between two antenna inputs and easily select the preferred audio frequency by using the selection buttons placed on the left part of the screen. The first 14 channels set in the Logger tab (see “Logger” on page 71) will be listed on the left section of the WEB interface and can be used as station presets. Below is a screenshot to depict the correlation between the Logger tab and station presets.

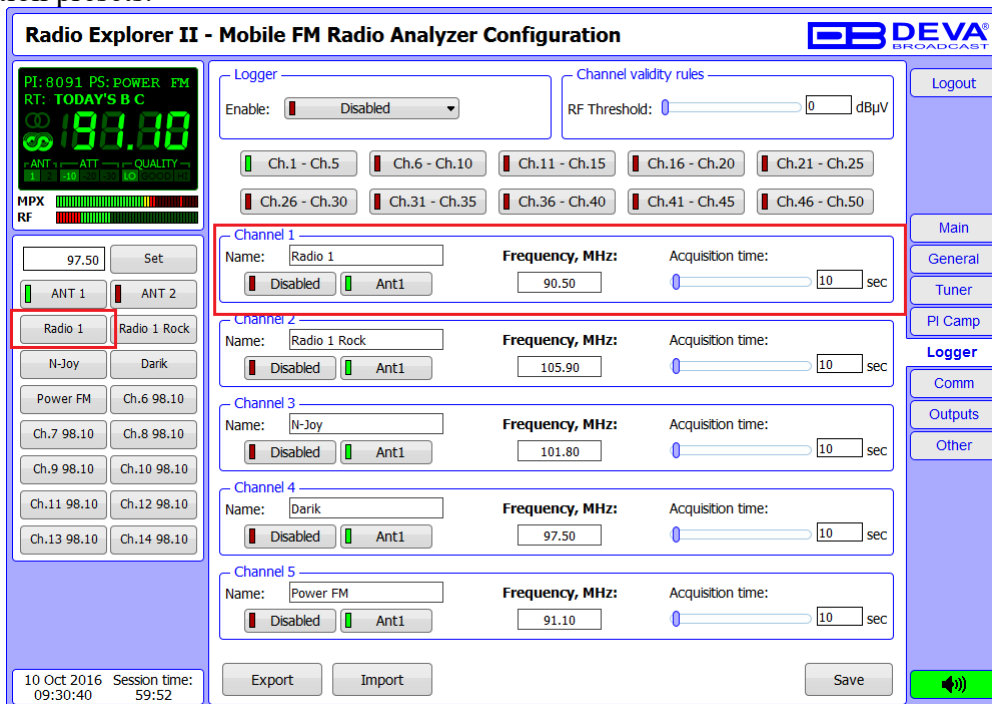

RDS/RBDS PAGE

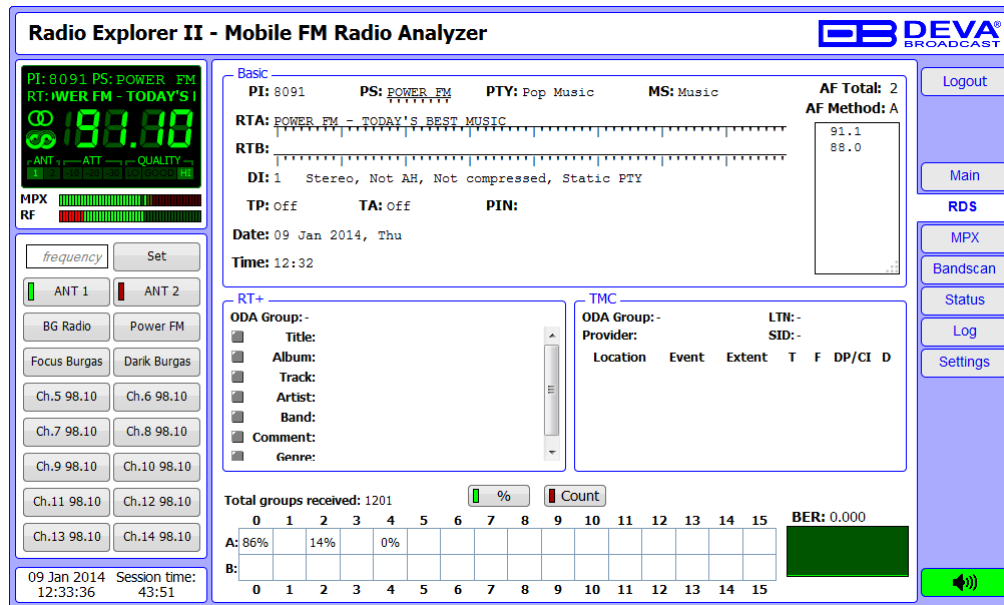

The screenshot displays the 'Radio Explorer II - Mobile FM Radio Analyzer' interface. The main window is divided into several sections:

- Basic:** Shows RDS data including PI: 8091, PS: POWER FM, PTY: Pop Music, MS: Music, AF Total: 2, AF Method: A, RTA: POWER FM - TODAY'S BEST MUSIC, RTB: (empty), DI: 1 Stereo, Not AH, Not compressed, Static PTY, TP: Off, TA: Off, PIN: (empty), Date: 09 Jan 2014, Thu, and Time: 12:32.
- RT+ (Radio Text):** Includes fields for ODA Group, Title, Album, Track, Artist, Band, Comment, and Genre.
- TMC (Traffic Message Channel):** Includes fields for ODA Group, Provider, LTN, and SID, with a table for Location, Event, Extent, T, F, DP/CI, and D.
- Total groups received:** 1201. A table shows the distribution of groups across 16 channels (0-15). Channel 2 has 14% (0% count), and Channel 3 has 0% (0% count). Channel 0 has 86%.
- BER (Bit Error Rate):** 0.000. A green bar indicates the BER history over the last 60 seconds.
- Left Panel:** Contains frequency controls, antenna selection (ANT 1, ANT 2), and a list of alternative frequencies (e.g., Ch.5 98.10, Ch.6 98.10, etc.).
- Right Panel:** Contains navigation buttons: Logout, Main, RDS, MPX, Bandscan, Status, Log, and Settings.

All basic elements of the RDS/RBDS are displayed on the screen – PI, PS, RT, TA/TP and etc. The Alternative frequencies are also available, represented as a list. The Open Data Applications are left blank for further definition, by default. Only two of these ODA Groups are defined. At your disposal are the Radio Text and the Traffic Message Channel.

If your Radio station has RT+ or TMC – Radio Explorer II will display the information from the ODA Groups.

A BER Indicator with graphics is placed at the right bottom part of the screen, showing 60 sec. history of the BER quantities.

NOTE: The bit error rate or bit error ratio (BER) is the number of bit errors divided by the total number of transferred bits during a studied time interval. Result closer or equal to 0 indicates that no bit errors are detected and vice versa result closer or equal to 1 indicates that the received transferred bits are only errors.

Total groups Indicator – all received groups are systematized into a table, representing the percentage/quantity of the groups in the received RDS/RBDS signal. The user selects how the “Total groups received” data should be displayed: as Percents (%) or Count, by selecting the corresponding button.

MPX PAGE

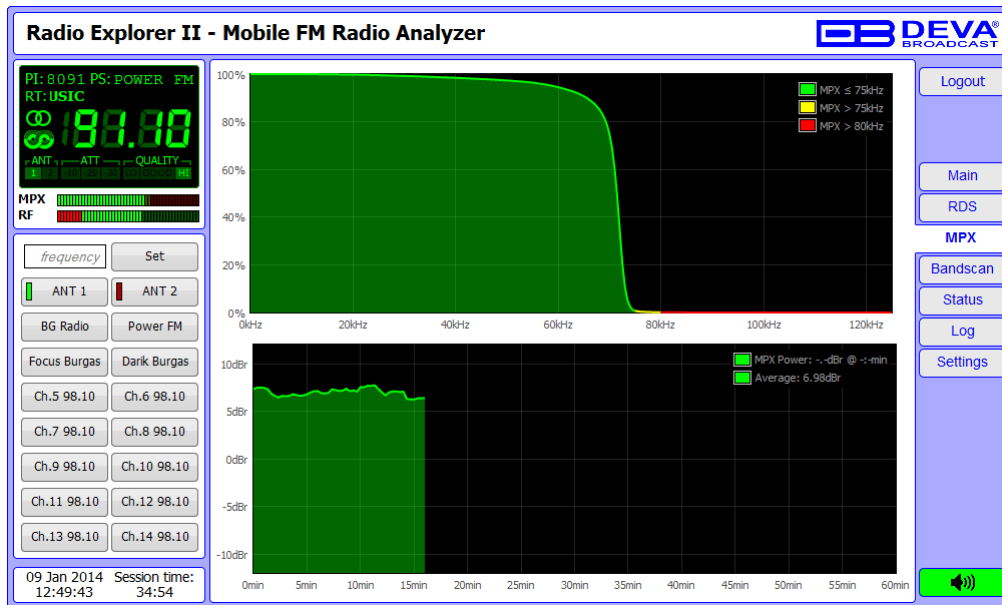

The graphic represents the MPX Deviation overshoot (in percentage) over time. Standard overshoot is measured at 75 kHz and is indicated in the top right corner of the graphic.

The graphic below the MPX Deviation represents the MPX Power over the time span of 60 min. This signal has an initial integration time of 1 min, after that a new sample will be available every 20 seconds.

The radio frequency to be observed could be easily set by using the preset buttons, placed on the left part of the screen.

BANDSCAN PAGE

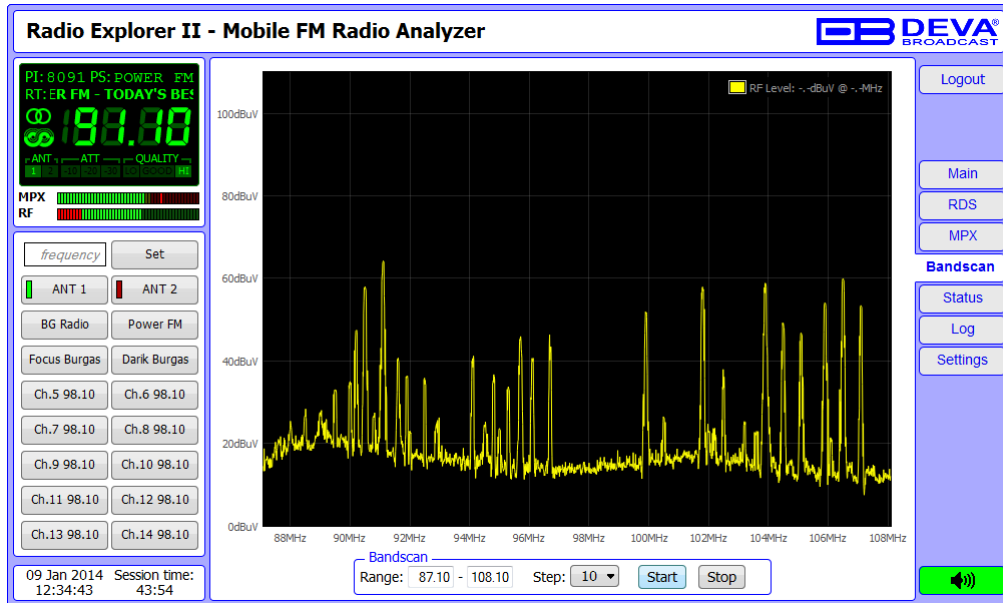

The BandScan application utilizes four different types of Band Scan, depending on the preferred signal frequency step. The bandscanning mode could be customized by setting low and high frequency of the scan. Once you have set the frequency step and low/high frequency, the start button should be pressed in order for the BandScan process to be initiated.

STATUS PAGE

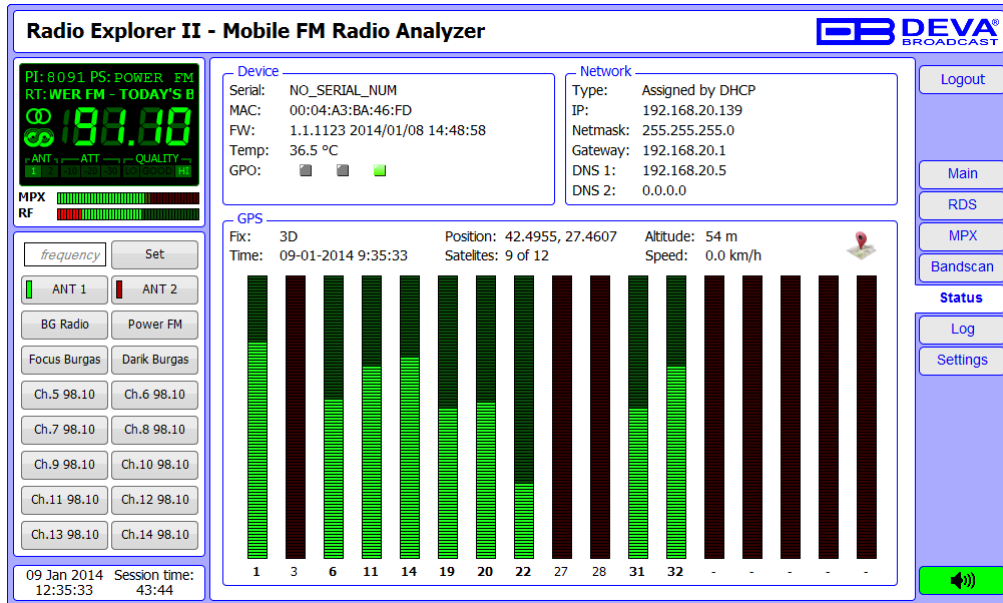

The screenshot shows the 'Radio Explorer II - Mobile FM Radio Analyzer' interface. It features a top navigation bar with the DEVA BROADCAST logo and a 'Logout' button. The main content area is divided into several sections:

- Device Information:**
 - Serial: NO_SERIAL_NUM
 - MAC: 00:04:A3:BA:46:FD
 - FW: 1.1.1123 2014/01/08 14:48:58
 - Temp: 36.5 °C
 - GPO: [Status indicators]
- Network Information:**
 - Type: Assigned by DHCP
 - IP: 192.168.20.139
 - Netmask: 255.255.255.0
 - Gateway: 192.168.20.1
 - DNS 1: 192.168.20.5
 - DNS 2: 0.0.0.0
- GPS Information:**
 - Fix: 3D
 - Time: 09-01-2014 9:35:33
 - Position: 42.4955, 27.4607
 - Altitude: 54 m
 - Satellites: 9 of 12
 - Speed: 0.0 km/h
- Visualizations:**
 - A digital display on the left shows 'PI: 8091 PS: POWER FM', 'RT: WER FM - TODAY'S B', and a large '98.10' frequency reading.
 - Below the display are 'ANT 1' and 'ANT 2' indicators, and a 'frequency' table with 'Set' buttons for various channels (Ch.5 to Ch.14).
 - A central bar chart displays signal strength for various frequencies (1, 3, 6, 11, 14, 19, 20, 22, 27, 28, 31, 32).
- Navigation and Status:**
 - Buttons for 'Main', 'RDS', 'MPX', and 'Bandscan' are located on the right side.
 - A 'Status' section includes 'Log' and 'Settings' buttons.
 - A 'Speaker' icon is at the bottom right.

Sections Device and Network contain information about the current status of the device.

Section GPS contains information about the position and visualizes signal of all Satellites in view, that Radio Explorer II can detect.

“View position in Google Maps” button will open a new tab with a map indicating your current position.

LOG PAGE

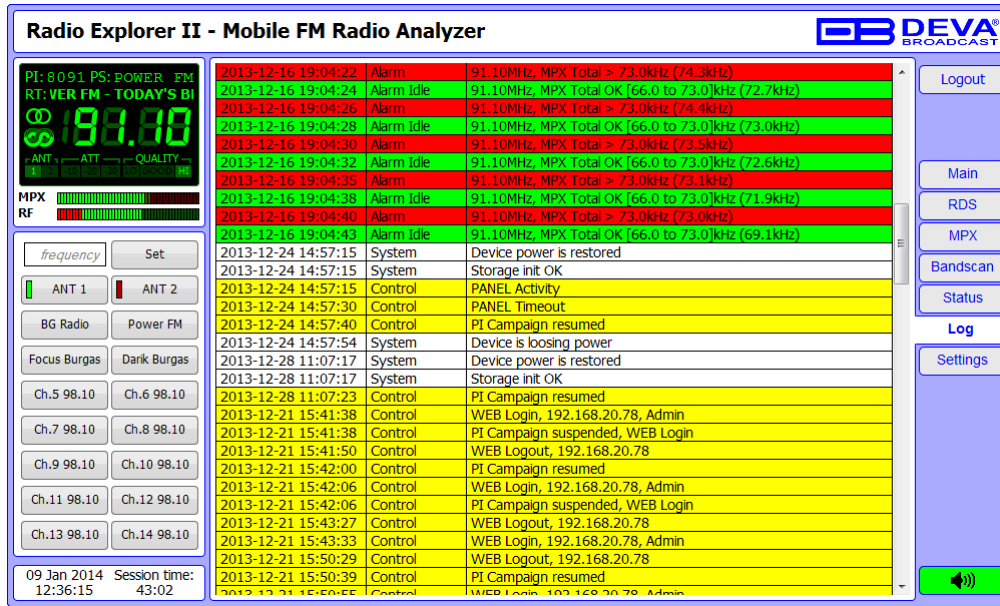

The screenshot displays the 'Radio Explorer II - Mobile FM Radio Analyzer' interface. On the left, there are control panels for frequency, antennas (ANT 1, ANT 2), radio modes (BG Radio, Power FM), and channel selection (Ch.5 to Ch.14). A central display shows 'PI: 8091 PS: POWER FM' and 'RT: VER FM - TODAY'S BI' with a large digital readout of '98.10'. Below this are MPX and RF signal strength indicators. The main area is a log table with columns for date/time, event type, and details. The log entries include 'Alarm', 'Alarm Idle', 'System', and 'Control' events with specific messages like 'MPX Total > 73.0kHz' and 'Device power is restored'. A right-hand sidebar contains navigation buttons: Logout, Main, RDS, MPX, Bandscan, Status, Log, and Settings.

Date/Time	Event Type	Details
2013-12-16 19:04:22	Alarm	91.10MHz, MPX Total > 73.0kHz (74.3kHz)
2013-12-16 19:04:24	Alarm Idle	91.10MHz, MPX Total OK [66.0 to 73.0]kHz (72.7kHz)
2013-12-16 19:04:26	Alarm	91.10MHz, MPX Total > 73.0kHz (74.4kHz)
2013-12-16 19:04:28	Alarm Idle	91.10MHz, MPX Total OK [66.0 to 73.0]kHz (73.0kHz)
2013-12-16 19:04:30	Alarm	91.10MHz, MPX Total > 73.0kHz (73.5kHz)
2013-12-16 19:04:32	Alarm Idle	91.10MHz, MPX Total OK [66.0 to 73.0]kHz (72.6kHz)
2013-12-16 19:04:35	Alarm	91.10MHz, MPX Total > 73.0kHz (73.1kHz)
2013-12-16 19:04:38	Alarm Idle	91.10MHz, MPX Total OK [66.0 to 73.0]kHz (71.9kHz)
2013-12-16 19:04:40	Alarm	91.10MHz, MPX Total > 73.0kHz (73.0kHz)
2013-12-16 19:04:43	Alarm Idle	91.10MHz, MPX Total OK [66.0 to 73.0]kHz (69.1kHz)
2013-12-24 14:57:15	System	Device power is restored
2013-12-24 14:57:15	System	Storage init OK
2013-12-24 14:57:15	Control	PANEL Activity
2013-12-24 14:57:30	Control	PANEL Timeout
2013-12-24 14:57:40	Control	PI Campaign resumed
2013-12-24 14:57:54	System	Device is losing power
2013-12-28 11:07:17	System	Device power is restored
2013-12-28 11:07:17	System	Storage init OK
2013-12-28 11:07:23	Control	PI Campaign resumed
2013-12-21 15:41:38	Control	WEB Login, 192.168.20.78, Admin
2013-12-21 15:41:38	Control	PI Campaign suspended, WEB Login
2013-12-21 15:41:50	Control	WEB Logout, 192.168.20.78
2013-12-21 15:42:00	Control	PI Campaign resumed
2013-12-21 15:42:06	Control	WEB Login, 192.168.20.78, Admin
2013-12-21 15:42:06	Control	PI Campaign suspended, WEB Login
2013-12-21 15:43:27	Control	WEB Logout, 192.168.20.78
2013-12-21 15:43:33	Control	WEB Login, 192.168.20.78, Admin
2013-12-21 15:50:29	Control	WEB Logout, 192.168.20.78
2013-12-21 15:50:39	Control	PI Campaign resumed
2013-12-21 15:50:55	Control	WEB Login, 192.168.20.78, Admin

Here are listed all Device System Events. The local measurements and logs are saved in the internal device memory. All log files can be downloaded via the built-in FTP server.

For information on how the connection between the Radio Explorer II and an FTP Client should be configured, please refer to [“Download files via FTP” on page 88.](#)

GENERAL SETTINGS PAGE

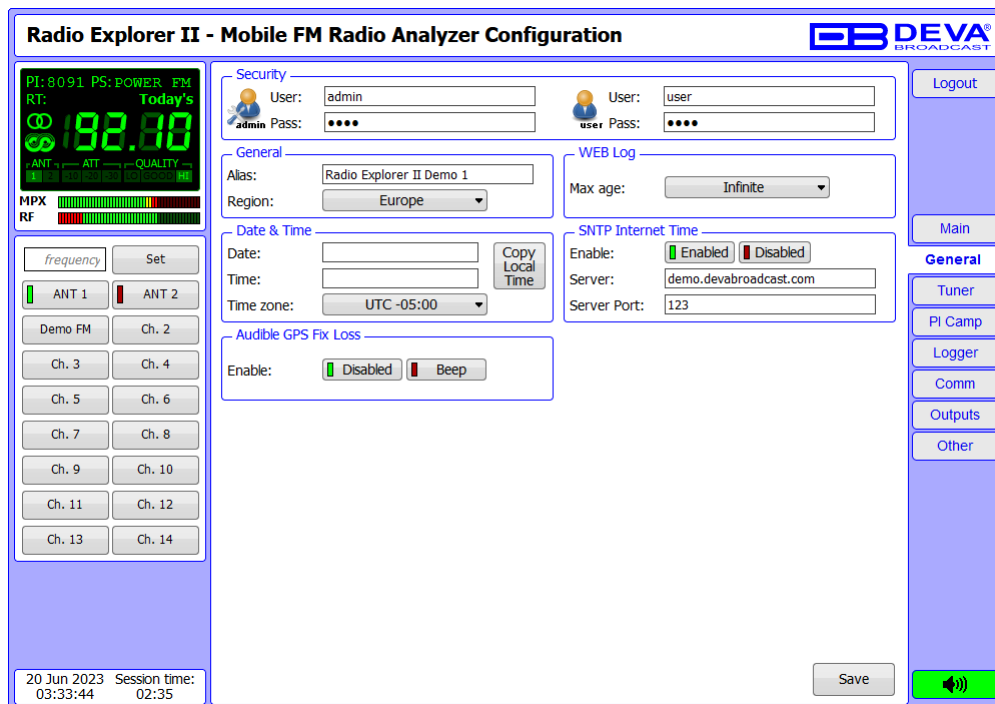

Radio Explorer II provides you with protected access to the device settings. You can choose between two types of log in.

- As an ADMINISTRATOR – It will give you full control over the device’s settings;
- As a USER – that will allow you to just monitor the device and to choose different stations, while the SETTINGS bar remains locked.

In order for the security of Radio Explorer II to be enhanced, new username and password could be set from the “Security” section.

Alias – allow the name of the device to be changed. Later on, it will be used as a title name on all WEB pages. Customizing the name will make the device more recognizable.

Region – Radio Explorer II’s tuning range is user selectable, 87.1-108 MHz (CCIR), 65-74 MHz (OIRT), 76-95 MHz (Japan). Changing/selecting the Region setting, will modify all tuner frequencies so that they could be within the FM band limits of the region chosen. This includes all Presets and Logger Channel frequencies.

WEB Log – the maximum storage time of the log files is chosen from here.

Date & Time – used for manually determining the current Date and Time. “Copy Local Time” button will set the Date and Time to correspond to that of your computer.

SNTP Internet Time – Synchronizes automatically the Radio Explorer II clock time to a millisecond with the Internet time server. Enable this function in order to use it (Specifying the server closest to your location will improve the accuracy).

Audible GPS Fix Loss – If enabled, upon loss of the GPS fix, the Radio Explorer II will generate a signal indicating GPS fix loss. The signal will be generated by the device itself and will be heard by the operator immediately as headphones or access to the WEB Interface/Software is NOT needed.

NOTE: In order the applied settings to be used press the “SAVE” button, placed on the bottom right part of the screen.

TUNER SETTINGS PAGE

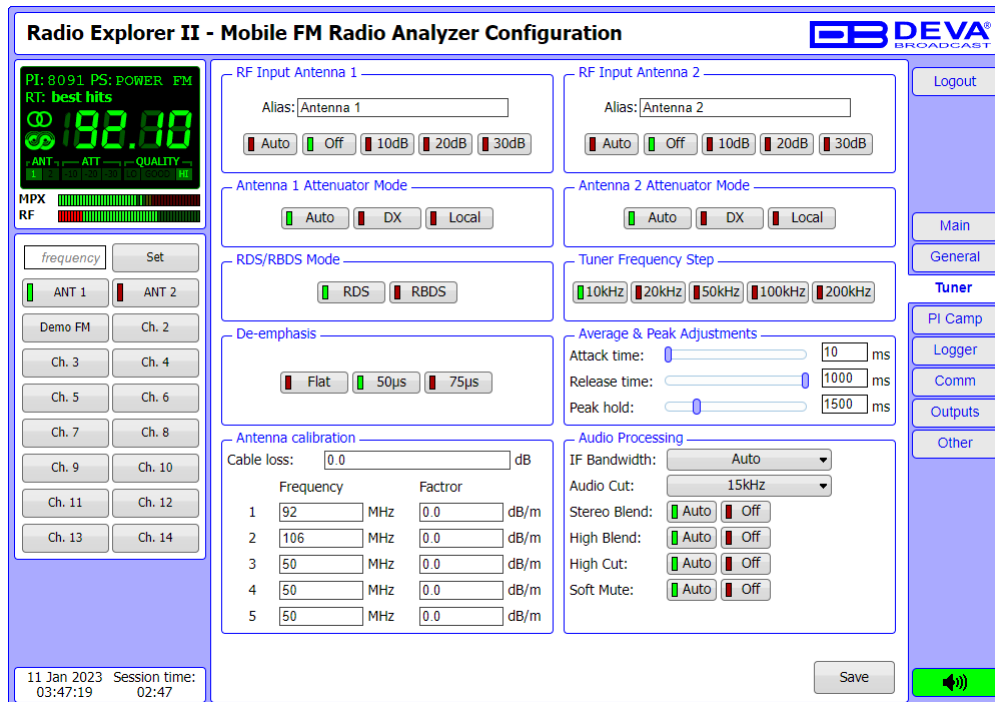

Radio Explorer II - Mobile FM Radio Analyzer Configuration

DEVA BROADCAST

Logout

RF Input Antenna 1
 Alias: Antenna 1
 Auto Off 10dB 20dB 30dB

RF Input Antenna 2
 Alias: Antenna 2
 Auto Off 10dB 20dB 30dB

Antenna 1 Attenuator Mode
 Auto DX Local

Antenna 2 Attenuator Mode
 Auto DX Local

RDS/RBDS Mode
 RDS RBDS

De-emphasis
 Flat 50µs 75µs

Antenna calibration
 Cable loss: 0.0 dB

	Frequency	Factor
1	92 MHz	0.0 dB/m
2	106 MHz	0.0 dB/m
3	50 MHz	0.0 dB/m
4	50 MHz	0.0 dB/m
5	50 MHz	0.0 dB/m

Tuner Frequency Step
 10kHz 20kHz 50kHz 100kHz 200kHz

Average & Peak Adjustments
 Attack time: 10 ms
 Release time: 1000 ms
 Peak hold: 1500 ms

Audio Processing
 IF Bandwidth: Auto
 Audio Cut: 15kHz
 Stereo Blend: Auto Off
 High Blend: Auto Off
 High Cut: Auto Off
 Soft Mute: Auto Off

frequency Set
 ANT 1 ANT 2
 Demo FM Ch. 2
 Ch. 3 Ch. 4
 Ch. 5 Ch. 6
 Ch. 7 Ch. 8
 Ch. 9 Ch. 10
 Ch. 11 Ch. 12
 Ch. 13 Ch. 14

11 Jan 2023 Session time:
 03:47:19 02:47

Save

Main
 General
Tuner
 PI Camp
 Logger
 Comm
 Outputs
 Other

The Tuner Section gives full control over the two RF Antenna Inputs, Tuner and Audio Processing settings.

These settings provide all needed adjustments to the algorithm which Radio Explorer II demodulates and manipulates the signal according your needs.

Average and Peak Adjustments this section is used for setting of the indicators response times.

Attack and Release times set the rate in which the indicators level will change in response to the signal. For most applications (including this one), the recommended attack time is shorter than the release time.

Peak hold time – Permits retaining and displaying the peak value reached by the signal for a predefined by the user period of time.

In order for the RF Field Strength to be calculated the used antenna parameters should be specified. The necessary adjustments are made in “Antenna calibration” section.

COMMUNICATION SETTINGS PAGE

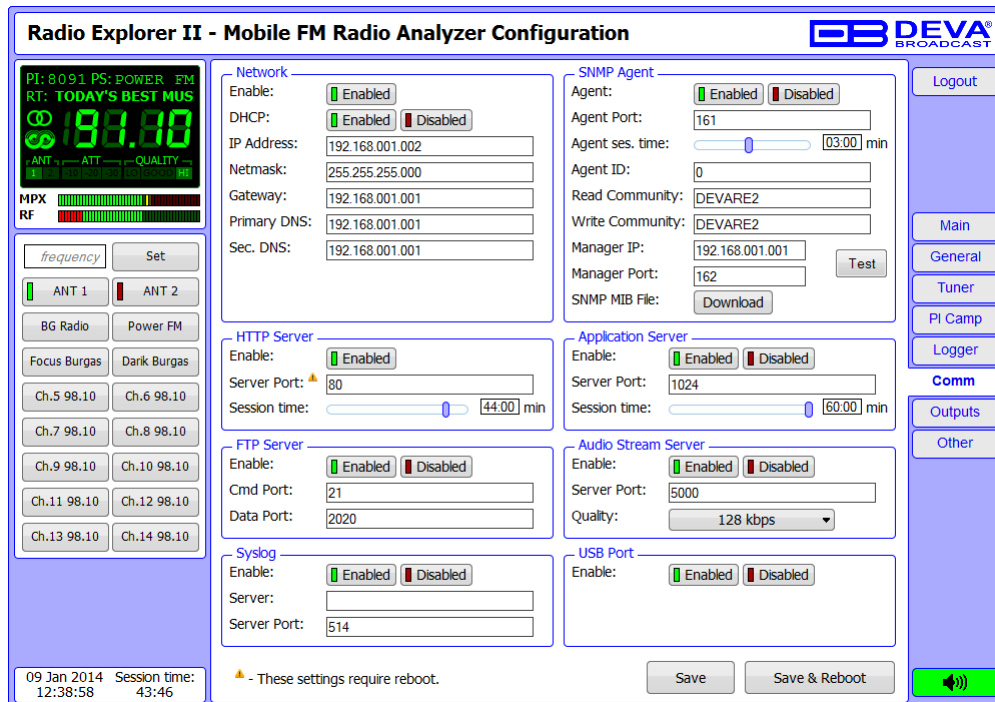

Radio Explorer II - Mobile FM Radio Analyzer Configuration

Network
 Enable: Enabled Disabled
 DHCP: Enabled Disabled
 IP Address: 192.168.001.002
 Netmask: 255.255.255.000
 Gateway: 192.168.001.001
 Primary DNS: 192.168.001.001
 Sec. DNS: 192.168.001.001

SNMP Agent
 Agent: Enabled Disabled
 Agent Port: 161
 Agent ses. time: 03.00 min
 Agent ID: 0
 Read Community: DEVARE2
 Write Community: DEVARE2
 Manager IP: 192.168.001.001
 Manager Port: 162
 SNMP MIB File: Download

HTTP Server
 Enable: Enabled Disabled
 Server Port: 80
 Session time: 44.00 min

Application Server
 Enable: Enabled Disabled
 Server Port: 1024
 Session time: 60.00 min

FTP Server
 Enable: Enabled Disabled
 Cmd Port: 21
 Data Port: 2020

Audio Stream Server
 Enable: Enabled Disabled
 Server Port: 5000
 Quality: 128 kbps

Syslog
 Enable: Enabled Disabled
 Server:
 Server Port: 514

USB Port
 Enable: Enabled Disabled

09 Jan 2014 Session time: 12:38:58 43:46

▲ - These settings require reboot.

Save Save & Reboot

From this section of the sub-menu, all general communication settings to the Network, SNMP Agent, HTTP Server, Application Server, FTP Server, Audio Stream Server, Syslog and USB Port could be applied.

The MIB file may vary from one firmware revision to another. Downloading this file from the device guarantees that you have the latest MIB file.

The WEB session timeout can be changed via HTTP server subsection. To extend the session duration set the Session time to a user defined value, then click on [Save] to save the changes. Disconnect and reconnect the device in order for the newly applied session timeout to be used.

OUTPUTS SETTINGS PAGE

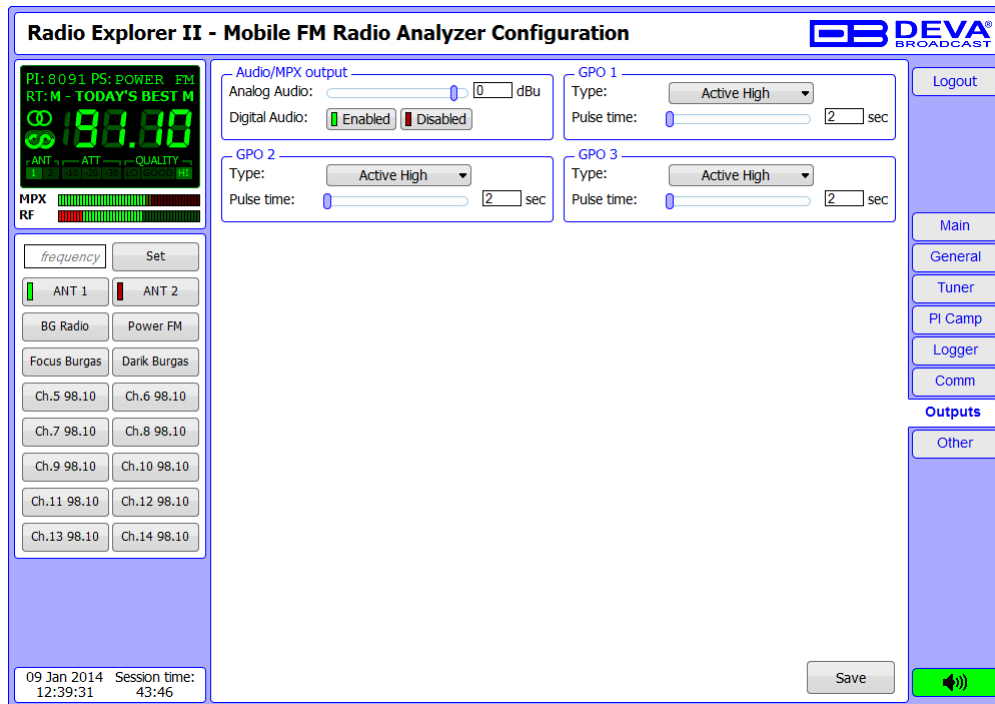

The general purpose outputs settings are applied through this page. The Audio/MPX output section allows the setting of the Audio and MPX Outputs, according to your needs.

The three General Purpose Outputs are assigned as follows:

- GPS Fix (GPO 1) – Indicates if GPS fix is available;
- Low Level RF (GPO 2) – Indicates Low RF signal level. The Low RF Level under which the output will activate should be specified.
- Multipath (GPO 3) – Indicates the presence of high disturbance in the signal (measured in %). From this page the level of disturbance which will activate the output can be specified.

OTHER SETTINGS PAGE

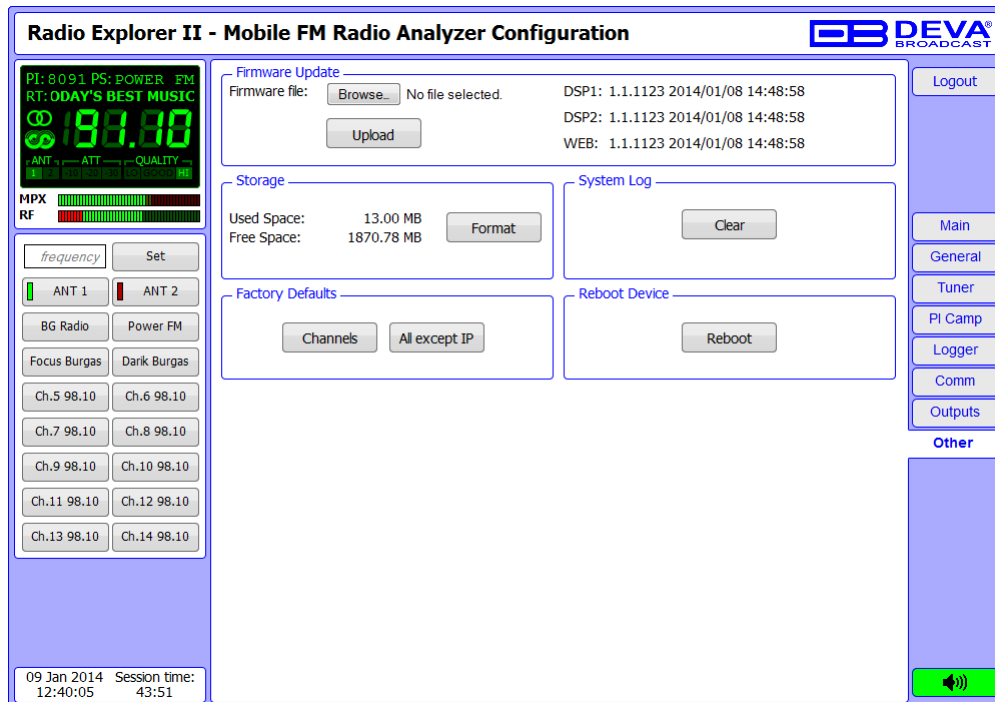

Firmware Update

To update the device firmware, select the new firmware file. After having pressed the Upload button, a dialog window will appear. Confirm the firmware update and wait for the process to complete.

Factory Defaults

Radio Explorer II utilizes two types of Factory Defaults:

- All except IP – all settings except for the Network settings (IP Address) will be deleted;
- Channels – all settings applied to the channels of the Logger and the PI/CALL campaign will be returned to the factory defaults.

To restore Radio Explorer II to its Factory Defaults you should first select the desired option and then press the relevant button. A new window will appear - confirm that you want to restore the factory defaults and wait for the process to be completed. On completion of the process, the settings should have the proper default values.

[\(see “Restore factory defaults” on page 51\)](#) [\(see “List of Settings” on page 74\)](#)

Reboot

To start Rebooting of Radio Explorer II, press the Reboot button. A dialog warning window will appear. Confirm that you want to reboot the device and wait for the process to be completed.

Storage and System Log

These sections of the menu enable the user to clear the system log and format Radio Explorer II storage.

PI CAMPAIGN AND LOGGER MODE

Differences between PI campaign and Logger Mode.

Which type of campaign should I choose?

Designed for signal surveillance on the field where the listeners are, all that is needed is a vehicle and Radio Explorer II. There are two campaign modes:

1. **Logger mode** – Through this section of the WEB Interface, up to fifty radio frequencies could be chosen and monitored, by applying the needed settings. When the desired adjustments are made, Radio Explorer II will monitor all of the selected frequencies at regular intervals. All of the collected information is accessible through the built-in FTP Server;
2. **RDS PI / RBDS CALL campaign** – Radio Explorer II can monitor up to ten stations at regular intervals. When used in this mode, Radio Explorer II will automatically detect the used frequency. While the campaign is running, the chosen stations will be monitored; Radio Explorer II will automatically switch over between the variable frequencies during movement - just as the car radio of your listeners. It is necessary that the campaign frequencies/channels and supplemental Radio Explorer II settings be pre configured before starting a campaign. No additional adjustments or settings will be required, except for the occasion when the campaign is to be stopped.

RDS PI / RBDS CALL campaign - PI campaign

- The PI campaign is suitable solution when monitoring of an entire network is made. In order for a PI/CALL campaign to be made, the channels you would like to monitor must have RDS PI / RBDS CALL signs.
- This campaign type is very convenient when it is not preliminary known which transmitters will be in the range of the survey, but the PI or CALL signs of the stations are available.
- When used to monitor an entire network, the PI campaign allows you to set-up the PI/CALL signs once and use them in campaigns for unlimited time without the need of changing them depending on the region of survey.
- Allows you to identify the zones of switch over from one transmitter to another.

Logger mode

- The Logger mode is suitable solution when monitoring of a preliminary identified frequencies should be made.
- This campaign type is very convenient when a survey for the coverage of one transmitter in a particular city or region should be made.
- Appropriate when several transmitters in a relatively small region should be monitored and all channels of interest are broadcasted at the same time/simultaneously.

Upon completion of the campaign, the data from the log measurements of the signal, will be presented as a graphic, located on a map. The graph is formed by examining points which follow a certain sequence and forming the resultant “travel path”. Using the supplied free of charge Windows software the log files could be converted into KMZ format and visualized in Google Earth. Such functionality is irreplaceable when current information of the FM broadcast band congestion and coverage is needed. As an addition, the Log file can be also exported and saved as a transitional format for future analysis.

The LOG files can be downloaded via a standard FTP client or trough the DEVA Device Manager Software. For detailed information on how to download the files via:

- FTP - For information on how the connection between the Radio Explorer II and an FTP Client should be configured, please [refer to “Download files via FTP” on page 88](#).

- DEVA Device Manager Software - please refer to the complete user manual. It is available for downloading from our website - www.devabroadcast.com/downloads

WEB Interface control options explained

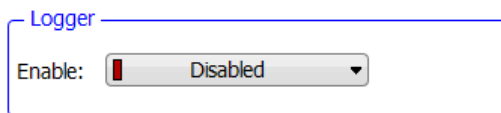

PI Campaign / Logger subsection – generally enables/disables the campaign. In order for a campaign to be performed, the setting should be enabled and set to the desired time.

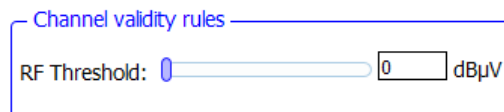

Channel validity rules – When the RF level of channel at which the Radio Explorer II is currently tuned is below the specified threshold, the data collection will be stopped and the unit will switch to the next channel. Correctly set, this parameter will filter the unneeded information if the field intensity in the analyzed point is below the specified RF threshold. The value is user defined and is set depending on the antenna used. If the Radio Explorer II is to be used with the included in the set antenna, the recommended value of the RF Threshold is 25 dBµV. If the default value is left, the analyzed points will not be filtered and there might be points with missing information on the map.



Buttons [Ch.1 - Ch,5], [Ch.6 - Ch.10] to [Ch.46 - Ch.50] are used for easy navigation through the list of all monitored stations.



[Export] and **[Import]** are options identical for both the PI Camp and Logger, and are explained in details below.

[Export] – Pressing export will export the list of the channels and the settings applied. This option is very useful when several devices in one region are used, or just to store the information for future usage. To export the list of channels and their settings, follow the instructions below:

1. Press [Export], a new dialog window will appear;
2. Choose a directory to save the (*.ssi) file;
3. Press [Save].

[Import] – Allows you to import a preliminary saved list of the channels and their settings. To import the list of channels and their settings, follow the instructions below:

1. Press [Import], a new dialog window will appear;

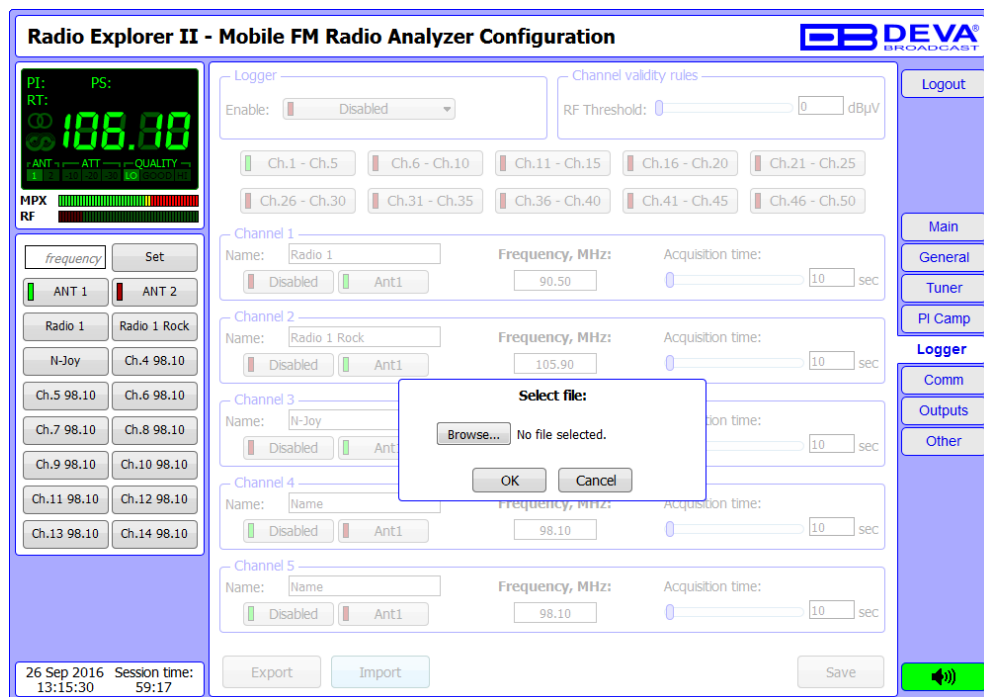

2. Choose a PI campaign (*.ssi) file to be uploaded;
3. Press [OK] and wait for the process to be completed;
4. Press [Save] to save the changes.

Important recommendations when acquisition time is set

Acquisition time defines the time between the examining points. Meaning that if the acquisition time is set to 10 seconds, the Radio Explorer II will mark a point on the map each 10th second of the campaign. Having in mind that the device will scan the channels preset after preset, the driving speed should be carefully considered.

Below is a table with the expected distance between the measurements of a particular point/frequency, depending on the speed and number of monitored channels, when the device is used in Logger Mode. Please note that the cited parameters are approximate and depend on the re-tuning time between the channels, and the overall configuration. As it can be seen from the table, the time period for two channels is more than two times bigger than the one needed for 1 channel as time for re-tuning is also added.

In PI campaign there are valid and not valid RF levels and CALL signs that have influence on the distance between the measurement points, hence approximate distance cannot be accurately presumed.

Approximate distance between the obtained measurement points of same frequency depending on the speed and number of channels monitored in Logger mode							
Number of monitored channels	Acquisition time	Speed 50km/h 31mph		Speed 90km/h 56mph		Speed 120km/h 75mph	
		m	feet	m	feet	m	feet
1	5 seconds	69	226	130	427	173	568
	10 seconds	137	449	252	827	335	1099
2	5 seconds	140	459	258	846	341	1119
	10 seconds	276	906	508	1667	701	2300
3	5 seconds	202	663	388	1273	508	1667
	10 seconds	413	1355	761	2497	1003	3291
4	5 seconds	273	896	509	1670	673	2208
	10 seconds	551	1808	1015	3330	1340	4396
5	5 seconds	345	1132	638	2093	842	2762
	10 seconds	692	2270	1265	4150	1682	5518
6	5 seconds	412	1352	760	2493	1180	3871
	10 seconds	830	2723	1512	4961	2004	6575
7	5 seconds	480	1575	890	2920	1335	4380
	10 seconds	964	3163	1765	5791	2340	7677
8	5 seconds	552	1811	1013	3323	1510	4954
	10 seconds	1105	3625	2020	6627	2675	8776
9	5 seconds	622	2041	1142	3747	1680	5512
	10 seconds	1242	4075	2270	7448	3010	9875
10	5 seconds	692	2270	1270	4167	1847	6060
	10 seconds	1395	4577	2535	8317	3342	10965

How to start a PI Campaign?

IMPORTANT: Prior to the set-up procedure, you will have to note that the campaigns (PI and Logger) cannot be performed simultaneously. The PI campaign is with higher priority, thus in order for a Logger mode campaign to be performed you will have to make sure that the PI Campaign is disabled.

Prior to applying any settings, a connection to the device via the WEB Interface should be made.

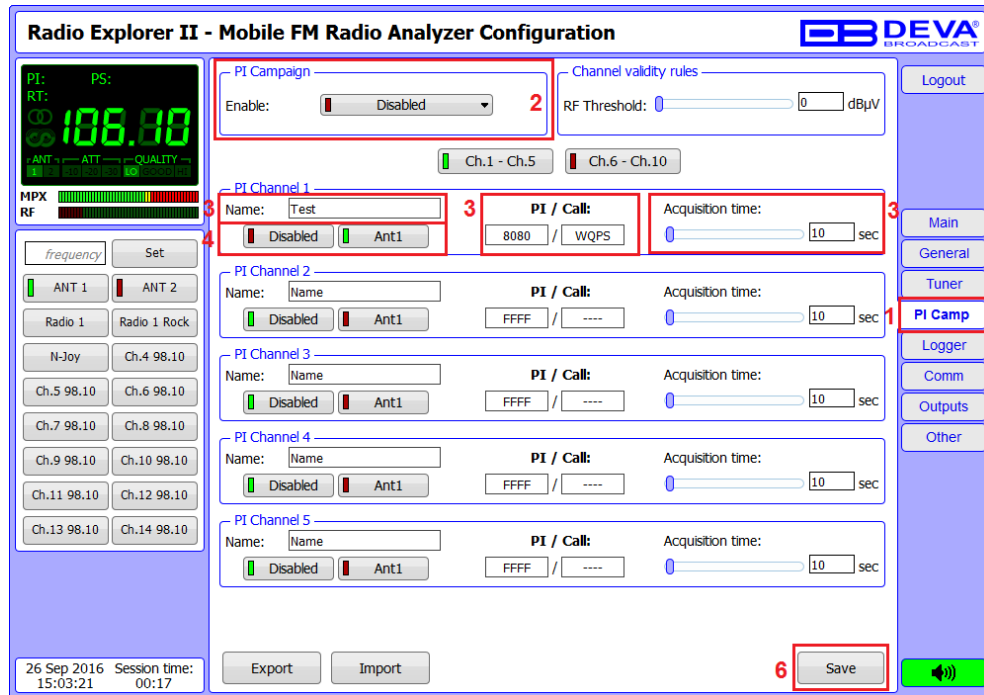

1. Open the main application window and go to **Settings> PI Camp** tab;
2. Set the Campaign's start time delay from the PI campaign box placed at the top of the window;
3. Set the following parameters for each of the stations you would like to observe – PI/CALL, Name of the station and Acquisition time (Radio Explorer II will automatically calculate the PI to CALL and vice versa);
4. In order for a station to be included in the campaign, the [Ant1] button should be selected; to exclude a station from the campaign the [Disable] button should be selected;
5. Steps from 2 to 4 should be applied for each of the channels to be monitored. Once all PI Channels are set you can proceed to the last step;
6. Press the [Save] button to save the applied changes;
7. Disconnect the device from the local network connection and wait for the campaign to be commenced.

NOTE: In order for a Campaign to be commenced the device should be inactive for the specified time. During the campaign, the device should be inactive. The front panel navigational menu, WEB Interface and Device Manager Software should not be used.

How to start a Logger campaign?

IMPORTANT: Prior to the set-up procedure, you will have to note that the campaigns (PI and Logger) cannot be performed simultaneously. The PI campaign is with higher priority, thus in order for a Logger mode campaign to be performed you will have to make sure that the PI Campaign is disabled.

NOTE: The first 14 channels set in the Logger tab will appear as station presets on the left section of the WEB interface.

Prior to applying any settings, a connection to the device via the WEB Interface should be made.

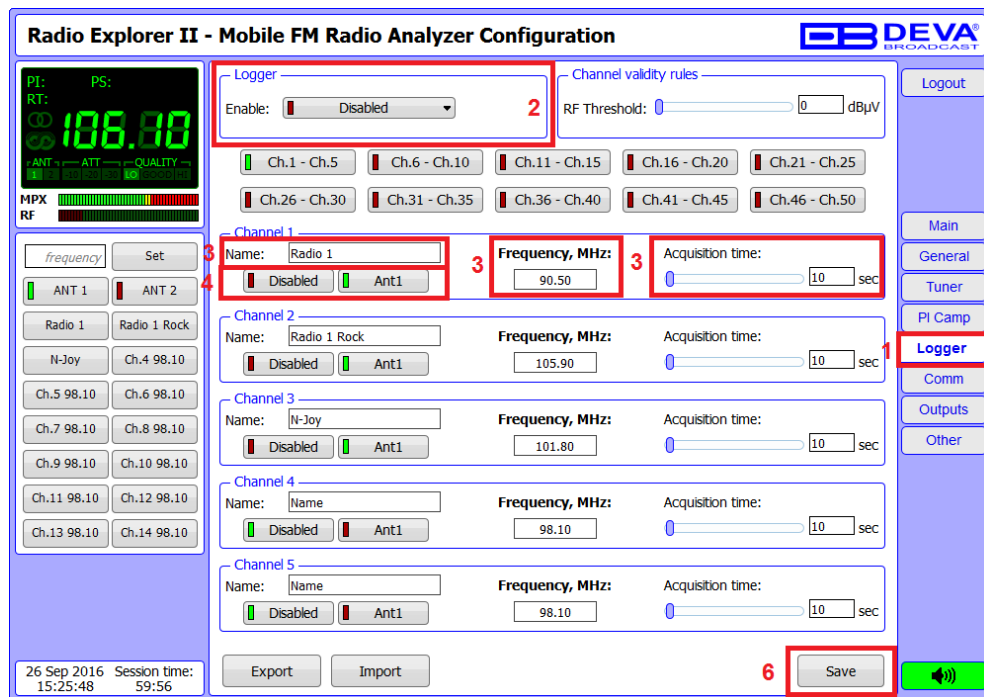

1. Open the main application window and go to **Settings > Logger** tab;
2. Set the Campaign's start time delay from the "Logger" box placed at the top of the window;
3. Set the Name, Frequency and Acquisition time parameters for each of the channels;
4. In order for a station to be included in the campaign, the [Ant1] button should be selected; to exclude a station from the campaign the [Disable] button should be selected;
5. Steps from 2 to 4 should be applied for each of the channels to be monitored. Once all channels are set you can proceed to the last step;
6. Press the [Save] button to save the applied changes;
7. Disconnect the device from the local network connection and wait for the campaign to be commenced

NOTE: In order for a Campaign to be commenced the device should be inactive for the specified time. During the campaign, the device should be inactive. The front panel navigational menu, WEB Interface and Device Manager Software should not be used.

Google Earth Visualization

Radio Explorer II is a Google Earth compatible tool for visualization of the collected FM Radio Measurements. Once a campaign is finalized, using the supplied DEVA Device Manager the collected files could be converted into KMZ format automatically and the results visualized in Google Earth.

Aimed at facilitating the use of our products, DEVA Device Manager Software is free of charge. The latest release can be found on our website www.devabroadcast.com

In order to avail yourself of all provided by the software advantages, please refer to DEVA Device Manager Software's user manual which could also be found on our website.

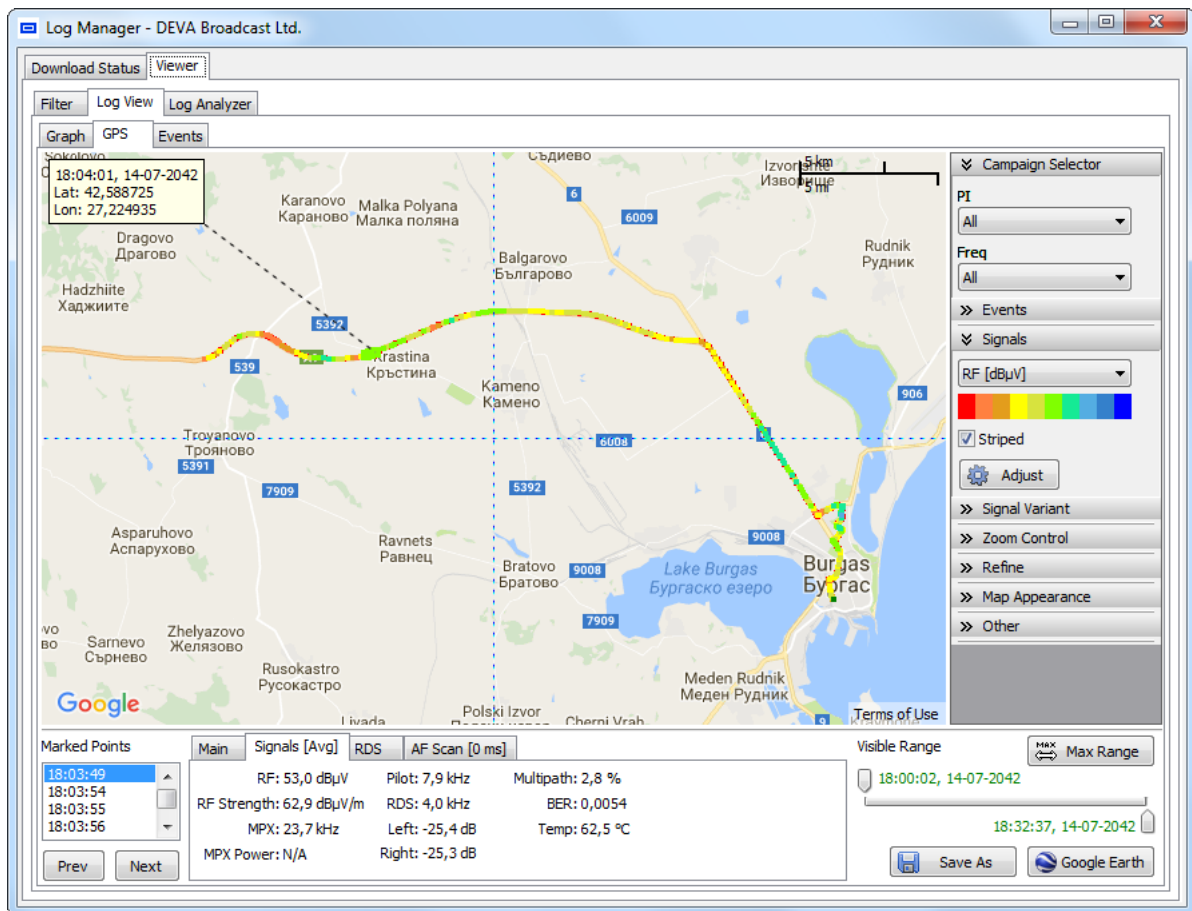

DEVA Device Manager Software visualization

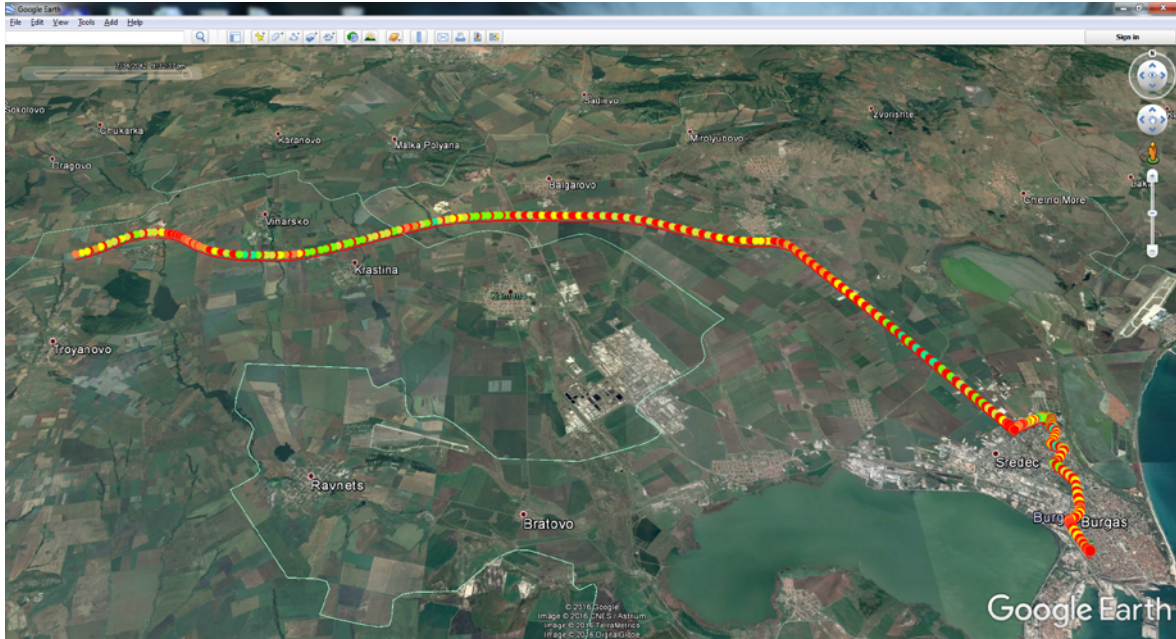

Google Earth Visualization

List of Radio Explorer II Settings

Parameter	Type	Possible values	Default value [,Unit]	Short description
Tuner				Tuner related submenu
Frequency	INT	87.1-108 MHz (CCIR), 65-74 MHz (OIRT), 76-95 MHz (Japan)	98.1	Currently set frequency
RF Input	ENUM	Antenna 1, Antenna 2	Antenna 1	Active RF antenna input
Attenuator Ant 1	ENUM	Auto, OFF, -10, -20, -30	Auto, dB	Attenuator setting for antenna input 1
Attenuator Ant 2	ENUM	Auto, OFF, -10, -20, -30	Auto,dB	Attenuator setting for antenna input 2
Frequency Step	ENUM	10, 20, 50, 100, 200	50, kHz	Step for frequency tuning
IF Bandwidth	ENUM	27, 36, 45, 53, 62, 71, 79, 88, 97, 105, 114, 123, 131, 140, 149, 157, Auto	Auto, kHz	IF filter bandwidth
Stereo Blend	ENUM	Auto, Off	Auto	Stereo blend level
High Cut	ENUM	Auto, Off	Auto	High cut level
High Blend	ENUM	Auto, Off	Auto	High blend level
Soft Mute	ENUM	Auto, Off	Auto	Soft mute level
Audio Cut	ENUM	5, 10, 15, Off	Off, kHz	Audio cut level
Deemphasis	ENUM	FLAT, 50, 75	50, μ s	De-emphasis settings
RDS Mode	ENUM	RDS, RBDS	RDS	RDS decoder mode
RF Loss Threshold	INT	0 ... 110, step 1	40, dB μ V	RF threshold level
RF Loss Timeout	TIMER	1 ... 60, step 1	1	RF timeout
Antenna factor				Antenna factor related submenu
Frequency 1	INT	50 ... 200, step 1	50, MHz	Frequency of Antenna factor 1
Factor 1	INT	0 ... 120, step 0.1	0	Antenna factor 1
Frequency 2	INT	50 ... 200, step 1	50, MHz	Frequency of Antenna factor 2
Factor 2	INT	0 ... 120, step 0.1	0	Antenna factor 2
Frequency 3	INT	50 ... 200, step 1	50, MHz	Frequency of Antenna factor 3
Factor 3	INT	0 ... 120, step 0.1	0	Antenna factor 3
Frequency 4	INT	50 ... 200, step 1	50, MHz	Frequency of Antenna factor 4
Factor 4	INT	0 ... 120, step 0.1	0	Antenna factor 4
Frequency 5	INT	50 ... 200, step 1	50, MHz	Frequency of Antenna factor 5

Parameter	Type	Possible values	Default value [,Unit]	Short description
Factor 5	INT	0 ... 120, step 0.1	0	Antenna factor 5
Cable Loss	INT	0 ... 20, step 0.1	0, MHz	Cable losses value
Average and Peak				Signal averaging related submenu
Attack Time	INT	0 ... 500, step 10	50, ms	Attack time for signal measuring
Release Time	INT	50 ... 1000, step 10	500, ms	Release time for signal measuring
Peak Hold	INT	500 ... 5000, step 500	1500, ms	Peak hold time
Communication				Communication related submenu
General Setup				General communication settings
Ethernet	ENUM	Enable, Disable	Enable	Ethernet port (general)
SNMP	ENUM	Enable, Disable	Enable	SNMP protocol
Application	ENUM	Enable, Disable	Enable	Application proprietary protocol
HTTP	ENUM	Enable, Disable	Enable	HTTP protocol (WEB server)
FTP	ENUM	Enable, Disable	Enable	FTP protocol
SNTP	ENUM	Enable, Disable	Enable	SNTP protocol (Internet time)
Audio Stream	ENUM	Enable, Disable	Enable	Audio streaming
Syslog	ENUM	Enable, Disable	Enable	SYSLOG protocol
UECP Server	ENUM	Enable, Disable	Enable	UECP TCP Server
UECP Relayer	ENUM	Enable, Disable	Enable	UECP UDP Relay
USB	ENUM	Enable, Disable	Enable	USB port
UPnP	ENUM	Enable, Disable	Enable	UPnP protocol
Ethernet				Ethernet related submenu
DHCP	ENUM	Enable, Disable	Enable	DHCP Client
IP	IP		192.168.1.2	IP address (static)
Network Mask	NETMASK		255.255.255.0	Network mask (static)
Gateway	IP		192.168.1.1	Gateway address (static)
Primary DNS	IP		192.168.1.1	Primary DNS IP address (static)
Secondary DNS	IP		192.168.1.1	Secondary DNS IP address (static)
WAN IP	IP		192.168.1.1	IP address used for FTP behind NAT
SNMP				SNMP related submenu
Manager IP	IP		192.168.1.1	Manager IP address

Parameter	Type	Possible values	Default value [,Unit]	Short description
Manager Port	PORT	1 ... 65535, step 1	162	Manager port
Agent Port	PORT	1 ... 65535, step 1	161	Agent port
Agent ID	INT	0 ... 255, step 1	0	Agent ID for the device
Read Community	STR		DEVARE2	Read community password
Write Community	STR		DEVARE2	Write community password
Session Timeout	TIMER	10 ... 3600, step 10	180	Inactivity timeout - for SNMP write only
Application				Application related submenu
Port	PORT	1 ... 65535, step 1	1024	Application port
Session Timeout	TIMER	10 ... 3600, step 10	180	Application inactivity timeout
HTTP				HTTP related submenu
Port	PORT	1 ... 65535, step 1	80	WEB server port
Session Timeout	TIMER	0 ... 3600, step 10	180	WEB session timeout
FTP				FTP related submenu
Data Port	PORT	1 ... 65535, step 1	2020	FTP data port
Command Port	PORT	1 ... 65535, step 1	21	FTP command port
SNTP				SNTP related submenu
Time Server	HOST		pool.ntp.org	Time server host name
Server Port	PORT	1 ... 65535, step 1	123	Time server port
Streamer				Audio streamer related submenu
Server Port	PORT	1 ... 65535, step 1	5000	Audio streamer server port
Bitrate	INT	64 ... 256, step 32	128, kbps	Audio bitrate
Syslog				SYSLOG related submenu
Server	HOST			Server host name
Port	PORT	1 ... 65535, step 1	514	Server port
Security				Security related submenu
Panel				Panel security settings
Access Control	ENUM	Enable, Disable	Disable	Front panel access control
Access Code	PORT	0 ... 9999, step 1	1234	Front panel access code
Access Timeout	TIMER	60 ... 3600, step 1	300	Access is granted timeout

Parameter	Type	Possible values	Default value [,Unit]	Short description
Remote Access				Remote control security settings
Admin Name	STR		admin	Admin access level name
Admin Password	STR		pass	Admin access level password
User Name	STR		user	User access level name
User Password	STR		pass	User access level password
Logger				Logger related submenu
Logger Mode	ENUM	Disable, 1, 2, 5, 10	Disable, min	Logger mode start time delay
Channel 1	CHANNEL	(see "Note 1" on page 79)		Settings for logger channel 1
...
Channel 50	CHANNEL	(see "Note 1" on page 79)		Settings for logger channel 50
PI Campaign				PI Campaign related submenu
PI Campaign Mode	ENUM	Disable, 1, 2, 5, 10	Disable, min	PI Campaign mode start time delay
PI Channel 1	PICHANNEL	(see "Note 2" on page 79)		Settings for PI Campaign channel 1
...
PI Channel 10	PICHANNEL	(see "Note 2" on page 79)		Settings for PI Campaign channel 10
GP Outputs				GPO pins related submenu
GPO1 Function	ENUM	GPS Fix	GPS Fix	GPO pin 1 function
GPO1 Type	ENUM	Level High, Level Low, Pulse High, Pulse Low	Level High	GPO pin 1 active level
GPO1 Pulse Time	TIMER	1 ... 120, step 1	2	GPO pin 1 pulse duration
GPO2 Function	ENUM	RF low	RF Low	GPO pin 2 function
GPO2 Type	ENUM	Level High, Level Low, Pulse High, Pulse Low	Level High	GPO pin 2 active level
GPO2 Pulse Time	TIMER	1 ... 120, step 1	2	GPO pin 2 pulse duration
GPO3 Function	ENUM	Mutipath	Multipath	GPO pin 3 function
GPO3 Type	ENUM	Level High, Level Low, Pulse High, Pulse Low	Level High	GPO pin 3 active level
GPO3 Pulse Time	TIMER	1 ... 120, step 1	2	GPO pin 3 pulse duration
Audio / MPX Outputs				Audio / MPX output related submenu
Phones Volume	INT	-60 ... 0, step 1	-12, dB	Head phones audio level
Audio Volume	INT	-60 ... 6, step 1	0, dBu	Audio output level
MPX Volume	INT	-60 ... 4, step 1	0, dBu	MPX output level
GSM Volume	INT	-60 ... 0, step 1	0, dB	GSM audio level

Parameter	Type	Possible values	Default value [,Unit]	Short description
Digital Out	ENUM	Enable, Disable	Disable	Digital audio output control
Device				Device related submenu
Alias	STR		Radio Explorer II	Alias name for device
Date / Time				Date / Time settings
Date	DATE	01-Jan-2012 ... 31-Dec-2100	dd-mm-yyyy	Manual set Date
Time	TIME	0:0:0 ... 23:59:59, step 1	hh:mm:ss	Manual set Time
Timezone	TZONE	-12:00 ... 14:00, step 30 min	hh:mm	Time zone
Front Panel				Front panel settings
Display Contrast	INT	0 ... 100, step 10	100, %	Display contrast
Display Brightness	INT	0 ... 100, step 10	50, %	Display brightness
LED Brightness	INT	0 ... 100, step 10	60, %	LED bars brightness
Screen Saver	ENUM	Disable, 1, 2, 5, 10	2, min	Screen saver control
Panel Timeout	TIMER	10 ... 600, step 10	10	Panel inactivity timeout
Loss				Loss LED settings
Audio Threshold	INT	-100 ... 0, step 1	-50, dB	Audio threshold level
Audio Timeout	TIMER	1 ... 60, step 1	1	Audio timeout
Multipath Threshold	INT	0 ... 100, step 1	15, %	Multipath threshold level
Multipath Timeout	TIMER	1 ... 60, step 1	1	Multipath timeout
RDS Timeout	TIMER	1 ... 60, step 1	1	RDS timeout
Home Screen	INT	0 ... 3, step 1	1	Select Device's home screen
Fan Control	ENUM	Auto, 25, 50, 75, 100	Auto, %	Fan speed control
Weblog Max Days	ENUM	Infinite, 5, 10, 15, 20, 25, 30	Infinite, day	Maximum age of WEB system log
Factory Defaults				Factory defaults settings
Apply to	ENUM	None, Channels, Retain Comm, All	None	Selects parameter group to apply defaults
Execute	ENUM	Done, Proceed	Done	Revert defaults to selected parameter group

NOTE 1: Default values for complex Channel parameters are as follows:

PARAMETER	TYPE	POSSIBLE VALUES	DEFAULT VALUE [,UNIT]	SHORT DESCRIPTION
CHANNEL 1 ... 50				
Name	STR		Name	Channel name
Frequency	INT	87.1-108 MHz (CCIR), 65-74 MHz (OIRT), 76-95 MHz (Japan)	98, MHz	Channel frequency
Active	ENUM	Disable, Antenna 1	Disable	Channel activity control
Acquisition Time	TIMER	5 ... 120, step 1	10, sec	Channel acquisition time

NOTE 2: Default values for complex PI Channel parameters are as follows:

PARAMETER	TYPE	POSSIBLE VALUES	DEFAULT VALUE [,UNIT]	SHORT DESCRIPTION
PI CHANNEL 1 ... 10				
Name	STR		Name	Channel name
PI / CALL	PI	0000 ... FFFF	FFFF	Channel PI / CALL
Active	ENUM	Disable, Antenna 1	Disable	Channel activity control
Acquisition Time	TIMER	5 ... 120, step 1	10, sec	Channel acquisition time

Troubleshooting

If you experience trouble with Radio Explorer II, try the following solutions. If the problem occurs again, contact your local dealer or DEVA Broadcast Ltd.

Situation	Solution
<ul style="list-style-type: none"> – Cannot turn on Radio Explorer II; – The power turns off suddenly. 	<ol style="list-style-type: none"> 1. Check whether the device is connected to the Power supply or the Car cigarette lighter; 2. Check whether the cables are properly connected; 3. Check whether the cable is not pinched/sheared by doors, windows or trunk lids.
<ul style="list-style-type: none"> – Nothing is displayed on the OLED display when the power is turned on. 	<ol style="list-style-type: none"> 1. Check whether the device is connected to the Power supply or the Car cigarette lighter; 2. Restart the device.
<ul style="list-style-type: none"> – The Power LED Indicator is turned on but nothing is displayed on the OLED screen. 	Restart the device.
<ul style="list-style-type: none"> – Cannot record on the internal memory. 	Check whether the internal memory is full. If so download all campaigns using the FTP server.
<ul style="list-style-type: none"> – You have formatted the internal memory by mistake. 	All the data on the memory card is deleted by formatting. You cannot restore it.
<ul style="list-style-type: none"> – I am having trouble installing DEVA Device Manager. 	Delete all installed files and start over the installation process.
<ul style="list-style-type: none"> – I have waited for 10 minutes, but Radio Explorer II still does not receive GPS Signal. 	<ol style="list-style-type: none"> 1. Check whether a suitable location for installation of the GPS antenna that provides a clear view of the sky for a good satellite reception is chosen; 2. Check whether the cables are properly connected; 3. Check whether the cable is not pinched/sheared by doors, windows or trunk lids; 4. Restart the device.
<ul style="list-style-type: none"> – Radio Explorer II does not receive signal from the Antenna Input/s, and I am sure that there are several stations in range. 	<ol style="list-style-type: none"> 1. Check whether the antenna is properly connected; 2. Select the other antenna input; 3. Restart the device.
<ul style="list-style-type: none"> – I have trouble entering the WEB Interface. 	<ol style="list-style-type: none"> 1. Due to the inability of some WEB Browsers to read the IP address format displayed on the screen of the device, the numbers included in the IP Address must be written without the leading zeros. For example: 192.168.020.068 must be written as 192.168.20.68; 2. Check whether the IP address is written correctly; 3. Use other WEB browser; 4. Restart your PC.

APPENDIX A

RDS: EUROPE VS AMERICA

The European Broadcasting Union (EBU) and its member countries originated the concept of “Radio Data” transmission. The European RDS specification, CENELEC Standard EN50067, was first published in 1984. It was revised in 1986, 1990, 1991 and 1992.

European RDS has grown in use following initial adoption of the Standard. RDS is nearly universal throughout Europe; it is almost impossible to find a European FM broadcasting station that does not carry a radio data subcarrier.

The popularity of RDS in Europe is very much in contrast with initial reluctance on the part of US broadcasters to embrace this technology. This can be ascribed to material differences in broadcasting practices.

Almost without exception, FM broadcasting in the United States is ‘detached’ and independent - each station originates its own programming. America’s National Public Radio might be considered as an exception, though for most of the broadcast day even NPR stations originate, or at least schedule, their own programs.

Most of European broadcasting is similar to the concept of network radio that was common in the US prior to the 1950s. In Europe, a central program originator may have many transmitting facilities of modest power situated throughout the country, at several different frequencies to blanket a designated service area. The European disposition, toward lower-power transmitters can be found on the “local radio” level, as well.

The European concept of a service area equates to the US broadcaster’s market. The subtle difference between these designations further characterizes broadcasting practices and ethics. RDS benefits the European broadcaster through almost an altruistic endeavor to be of service to his listeners. The US broadcaster is marketing his programming and is primarily interested in how he can create additional revenue from RDS.

THE RDS SYSTEM

RDS is a digital data channel, transmitted as a low-level subcarrier above the range of the composite stereo program signal in the FM baseband. The data transmission (baud) rate is comparatively low, yet it is quite robust because of data redundancy and effective error correction.

It is not within the scope of this Manual to cover the details of RDS subcarrier coding and modulation. For this, the reader is directed to the Specification appropriate to his location either the CENELEC EN50067 Specification for Europe or the United States NRSC Specification. Since the Manual will deal with specific implication of RDS implemented with the Radio Explorer II, it is assumed that the user is familiar with the RDS concept.

APPENDIX B.1

PTY Code Description Used in RBDS Mode – North America

PTY	Short Name	Description
1	News	News reports, either local or network in origin.
2	Information	Programming that is intended to impart advice.
3	Sports	Sports reporting, commentary, and/or live event coverage, either local or network in origin.
4	Talk	Call-in and/or interview talk shows either local or national in origin.
5	Rock	Album cuts.
6	Classic Rock	Rock oriented oldies, often mixed with hit oldies, from a decade or more ago.
7	Adult Hits	An up-tempo contemporary hits format with no hard rock and no rap.
8	Soft Rock	Album cuts with a generally soft tempo.
9	Top 40	Current hits, often encompassing a variety of rock styles.
10	Country	Country music, including contemporary and traditional styles.
11	Oldies	Popular music, usually rock, with 80% or greater non-current music.
12	Soft	A cross between adult hits and classical, primarily non-current softrock originals.
13	Nostalgia	Big-band music.
14	Jazz	Mostly instrumental, includes both traditional jazz and more modern “smooth jazz.”
15	Classical	Mostly instrumentals, usually orchestral or symphonic music.
16	Rhythm and Blues	A wide range of musical styles, often called “urban contemporary.”
17	Soft R and B	Rhythm and blues with a generally soft tempo.
18	Foreign Language	Any programming format in a language other than English.
19	Religious Music	Music programming with religious lyrics.
20	Religious Talk	Call-in shows, interview programs, etc. with a religious theme.
21	Personality	A radio show where the on-air personality is the main attraction.
22	Public	Programming that is supported by listeners and/or corporate sponsors instead of advertising.
23	College	Programming produced by a college or university radio station.
24	Spanish Talk	Call-in shows, interview programs, etc. in the Spanish language
25	Spanish Music	Music programming in the Spanish language
26	Hip-Hop	Popular music incorporating elements of rap, rhythm-and-blues, funk, and soul
27-28	Unassigned	
29	Weather	Weather forecasts or bulletins that are non-emergency in nature.
30	Emergency Test	Broadcast when testing emergency broadcast equipment or receivers. Not intended for searching or dynamic switching for consumer receivers. Receivers may, if desired, display “TEST” or “Emergency Test”.
31	Emergency	Emergency announcement made under exceptional circumstances to give warning of events causing danger of a general nature. Not to be used for searching - only used in a receiver for dynamic switching.

NOTE: These definitions can differ slightly between various language versions.

APPENDIX B.2

PTY Code Description Used in RDS Mode – Europe, Asia

PTY	Short Name	Description
1	News	Short accounts of facts, events and publicly expressed views, reportage and actuality.
2	Current affairs	Topical program expanding or enlarging upon the news, generally in different presentation style or concept, including debate, or analysis.
3	Information	Program the purpose of which is to impart advice in the widest sense.
4	Sport	Program concerned with any aspect of sport.
5	Education	Program intended primarily to educate, of which the formal element is fundamental.
6	Drama	All radio plays and serials.
7	Culture	Programs concerned with any aspect of national or regional culture.
8	Science	Programs about the natural sciences and technology.
9	Varied	Used for mainly speech-based programs usually of light-entertainment nature, not covered by other categories. Examples include: quizzes, games, personality interviews.
10	Pop	Commercial music, which would generally be considered to be of current popular appeal, often featuring in current or recent record sales charts.
11	Rock	Contemporary modern music, usually written and performed by young musicians.
12	Easy Listening	Current contemporary music considered to be “easy-listening”, as opposed to Pop, Rock or Classical, or one of the specialized music styles, Jazz, Folk or Country. Music in this category is often but not always, vocal, and usually of short duration.
13	Light classics	Classical Musical for general, rather than specialist appreciation. Examples of music in this category are instrumental music, and vocal or choral works.
14	Serious classics	Performances of major orchestral works, symphonies, chamber music etc., and including Grand Opera.
15	Other music	Musical styles not fitting into any of the other categories. Particularly used for specialist music of which Rhythm & Blues and Reggae are examples.
16	Weather	Weather reports and forecasts and Meteorological information.
17	Finance	Stock Market reports, commerce, trading etc.
18	Children’s programs	For programs targeted at a young audience, primarily for entertainment and interest, rather than where the objective is to educate.
19	Social Affairs	Programs about people and things that influence them individually or in groups. Includes: sociology, history, geography, psychology and society.
20	Religion	Any aspect of beliefs and faiths, involving a God or Gods, the nature of existence and ethics.
21	Phone In	Involving members of the public expressing their views either by phone or at a public forum.
22	Travel	Features and programs concerned with travel to near and far destinations, package tours and travel ideas and opportunities. Not for use for Announcements about problems, delays, or roadworks affecting immediate travel where TP/TA should be used.
23	Leisure	Programs concerned with recreational activities in which the listener might participate. Examples include, Gardening, Fishing, Antique collecting, Cooking, Food & Wine etc.
24	Jazz Music	Polyphonic, syncopated music characterized by improvisation.
25	Country Music	Songs which originate from, or continue the musical tradition of the American Southern States. Characterized by a straightforward melody and narrative story line.
26	National Music	Current Popular Music of the Nation or Region in that country’s language, as opposed to International ‘Pop’ which is usually US or UK inspired and in English.
27	Oldies Music	Music from the so-called “golden age” of popular music.
28	Folk Music	Music which has its roots in the musical culture of a particular nation, usually played on acoustic instruments. The narrative or story may be based on historical events or people.
29	Documentary	Program concerned with factual matters, presented in an investigative style.
30	Alarm Test	Broadcast when testing emergency broadcast equipment or receivers. Not intended for searching or dynamic switching for consumer receivers.. Receivers may, if desired, display “TEST” or “Alarm Test”.
31	Alarm	Emergency announcement made under exceptional circumstances to give warning of events causing danger of a general nature. Not to be used for searching - only used in a receiver for dynamic switching.

APPENDIX C

RDS APPLICATIONS SUPPORTED

Following is an alphabetical list of the RDS applications supported by Radio Explorer II. The standardized RDS application abbreviation is followed by an expansion of the application name and a short explanation of the function.

NOTE: Depending of the currently selected User interface the following RDS Applications are supported:

- Via WEB Interface: AF, CT, DI, M/S, PI, PIN, PS, PTY, RT, RT+, TA, TMC and TP
- Via Logger: PI, PTY, TA, TP, M/S, DI, PS, AF, RT
- Via DEVA Device Manager Software: All RDS Applications

AF

List of Alternative Frequencies: In order holes in the coverage area to be filled, list of all frequencies where identical program could be heard simultaneously can be included by the network broadcaster or one with low-power rebroadcast transmitters (translators). The RDS receiver (particularly the upscale car radio) constantly searches for the best signal that carries the same program. The radio will re-tune without noticeable interruption, when a better signal is found. The principal utility of this RDS function is with European radio networks and US stations with ‘translators.’

CT

Clock Time and date: Time and date codes should use Coordinated Universal Time (UTC) and Modified Julian Day (MJD). If $MJD = 0$, the receiver should not be updated. The listener, however, will not use this information directly and the conversion to local time and date will be made in the receiver’s circuitry. CT is used as time stamp by various RDS applications and thus it must be accurate.

DI

Decoder Information: This is one of several ‘flags’ that convey yes/no or other very basic data. This flag helps the receiver to indicate whether the broadcast is monaural or is transmitted in any of several methods of stereo or binaural broadcasting. As many as 16 encoding options may be accommodated! This is a rather esoteric function and, thus far, remains unused both in Europe and in the US.

ECC

Extended Country Code: RDS uses its own country codes. The first most significant bits of the PI code carry the RDS country code. The four bit coding structure only permits the definition of 15 different codes, 1 to F (hex). Since there are much more countries to be identified, some countries have to share the same code which does not permit unique identification. Hence there is the need to use the Extended Country Code which is transmitted in Variant 0 of Block 3 in type 1A groups and together with the country identification in bits b15 to b12 of the PI code render a unique combination. The ECC consists of eight bits.

EON

Enhanced Other Networks information: This feature can be used to update the information stored in a receiver about program services other than the one received. The alternative frequencies-PS name, Traffic Program and Traffic Announcement identification as well as Program Type and Program Item Number information can be transmitted for each other service. The relation to the corresponding program is established by means of the relevant Program Identification. Linkage information, consisting of four data elements, provides the means by which several program services may be treated by the receiver as a single service during times a common program is carried. Linkage information also provides a mechanism to signal an extended set of related services.

EWS

Emergency Warning System: The EWS is intended to provide coding for warning messages. These messages will be broadcasted only in case of emergency and will be evaluated by special receivers.

FFG

Free Format Groups: A provision has been included in the Radio Explorer II to transmit proprietary data directly within a legitimate RDS group. This is a special use of the encoder for non-standard applications.

IH

In House application: This refers to data to be decoded only by the operator. Some examples noted are identification of transmission origin, remote switching of networks and paging of staff. The applications of coding may be decided by each operator itself.

M/S

Music / Speech Switch: This flag simply indicates whether music or speech is the primary broadcast programming. The purpose of this function is not well explained in the respective Standards; hence it comes as no surprise that it is not widely used.

ODA

Open Data Applications: The Open Data Applications feature allows data applications, not previously specified in EN 50067, to be conveyed in a number of allocated groups in an RDS transmission. The allocated groups are indicated by using type 3A group which is used to identify to a receiver the data application in use in accordance with the registration details in the EBU/RDS Forum - Open Data Applications Directory and the NRSC Open Data Applications Directory.

PI

Program Identification: This block of data identifies the broadcast station with a hexadecimal numerical code, which becomes the “digital signature” of the station. The code is assigned by the broadcasting authorities in most countries, but in the US it is calculated from a numerical encoding of station call letters. The receiver processes the PI code to assist automatic tuning features (station memories), and to prevent false switching to alternative frequencies that might be shared by broadcasters in nearby regions.

PIN

Program Item Number: The code enables the designed to use this feature receivers and recorders to respond to the preselected by the user program item(s). This feature is used via scheduled program time, to which in order to avoid ambiguity is added the day of the month.

PS

Program Service Name: This is the station's "street name" that will appear on the receiver faceplate display. The PS can be up to eight characters in length (including spaces) and can be as simple as the station's call letters: KWOW or KWOW FM, or a slogan: NEWSTALK or LIVE 95. The Program Service Name is automatically displayed, even on the automobile receivers. Because of driving safety considerations broadcasters are generally discouraged from scrolling messages in this field. As a matter of fact, it is a violation of both the CENELEC and the NRSC standards to scroll the PS display, although the practice has become universally common.

PTY

Program Type: The PTY data flag identifies the station format from a collection of pre-defined categories. Many RDS receivers are able to seek the listener's preferred format automatically. This means that a car radio can switch from a fading station to a stronger one that carries the same variety of music, though not the very same program, as provided by AF switching. The PTY function of RDS helps a broadcaster catch 'transient audience' share. A listing of the PTY categories is given in ["PTY Code Description Used in RBDS Mode – North America" on page 82](#) and ["PTY Code Description Used in RDS Mode – Europe, Asia" on page 83](#).

Under some programming circumstances, the PTY identifier may be made 'dynamic,' changing between categories for a station that "dayparts" (changes its format for specific time periods). The PTY code is not meant to change from song to song or to accommodate a top-of-the-hour newscast, however.

PTYN

Program TYpe Name: The PTYN feature allows the predefined by the RDS/RBDS Standard PTY to be further described using user-defined text (e.g. PTY=4: Sport and PTY=8: Football). The PTYN is not intended to change the default eight characters of PTY which will be used during search or wait modes. Its purpose is to show in details the program type once tuned to a program. If the broadcaster is satisfied with the default PTY name, it is not necessary to use additional data capacity for PTYN. The Program Type Name is not intended to be used for automatic PTY selection and must not be used for giving sequential information.

RT

RadioText: This is a 64-character block of plain text that the listener can select for visual display on the faceplate of the radio by pressing an INFO button on the receiver. This function is not available on many automobile radios for safety reasons, which has precipitated the frowned-upon practice of scrolling the PS field instead.

Most radios have limited alphanumeric display capability, so the 64 characters of RadioText march across the front panel, much akin those annoying LED advertising signs found in airport buses or fast food emporia. Like the scrolling-PS implementation, RadioText can announce song titles and performers, run special promotions or contests, or broadcast sponsors' messages.

RT+

RadioText Plus is “semantic analogue radio”. It allows the RDS feature RadioText (RT) to be read by the FM RDS receiving terminals. Based on the RDS RT messages, RT+ is completely backwards compatible with RT. The usage of RT+ allows the listener/user to derive additional benefits from the RDS Radio Text service. It enables FM RDS receivers to “read” Radio Text (to recognize designated objects and make them manageable) by user’s direct access to specific elements of the Radio Text messages. For example, that element could be programme associated metadata like Title and Artist of the currently playing song or a news headlines. This provides the listener with an “mp3-player feeling” while listening to analogue FM radio. The elements can also carry additional service messages or information about the Radio Station such as the telephone number or the web address of the Radio Station’s hotline. These objects, or more accurately RT+ information elements carried in the RDS RadioText (RT) messages, are identified by their location within the RT messages and by the class code of their content type. Once an information element is received and understood, a receiver is able to, for example, store the different RT+ information elements and the listener may then select and request a specific content type from the radio’s memory at an instant in time that suits the listener’s needs. Thus the listener is no longer forced to watch the RT information passing (scrolling) by. Moreover, RT+ offers selected RT message elements to car drivers on a static display, without risk of distracting the attention of the driver. Furthermore, RT+ is well suited for mobile phones with built-in FM receivers: telephone numbers can be directly used to initiate calls, and web addresses can be used to start browsing the web content offered by the radio programme provider. Last but not least, RT+ is also used for satellite radio broadcasting via DVB-S. It may be adopted by DRM and DAB in the future, too.

TA

Traffic Announcement: This is a temporary flag added to the RDS data stream only as a traffic bulletin is being aired. Some RDS car radios can be set to search for traffic bulletins among various TP stations (see TP below) while tuned to a listener’s preferred program, or even while playing a tape or CD. As soon as any TP station broadcasts a traffic bulletin, the receiver temporarily switches-over to receive it. When the bulletin is finished, the receiver switches back to the original program, tape or CD.

TDC

Transparent Data Channels: The transparent data channels consist of 32 channels, which may be used to send any type of data.

TMC

Traffic Message Channel: This feature is intended to be used for the coded transmission of traffic information.

TP

Traffic Program Identification: The TP flag identifies the station as one that routinely broadcasts traffic bulletins for motorists as part of its normal, everyday programming. When the TP flag is displayed on the receiver faceplate, the radio is searching for traffic announcements. The radio keeps track of TP stations offering this service to speed up the search-and-switch process.

APPENDIX D

HOW SHOULD I CONFIGURE THE CONNECTION BETWEEN MY DEVA DEVICE AND AN FTP CLIENT?

In order for a connection to be established the following setting should be applied:

1. FTP Server Settings

The built-in FTP Server has four important parameters that should be configured: Command Port, Data Port, User name and Password. These parameters are to be used in the FTP client's connection configuration. Further information on how to change the FTP Server's settings and their respective default values can be found in the device's User manual.

WE RECOMMEND the usage of FileZilla (<https://filezilla-project.org>). This is a widespread open source software distributed free of charge, hence available for downloading from the Internet.

NOTE: The FTP Server can manage only one connection at a time. The FTP Server works in Passive mode. Hence, the FTP Client should also be set in passive mode.

2. IP Router and Port Translation Settings

If the connection to the device is made through a Network address translation (NAT) router or firewall, the port forwarding feature of the router should be configured. The port forwarding is usually set in the firewall section of the router's menu. As each router has different port forwarding procedure, we recommend you to refer to its complete manual. To allow proper data flow through the router, the FTP Command and FTP Data ports should be open.

NOTE: The FTP port numbers to be used in the port forwarding feature configuration can be found in the device.

3. Example of FTP Client (FileZilla) Settings

In some cases, FileZilla's "Quick connect" feature is not able to connect with the DEVA unit. That is why we recommend the device to be assigned in the program manually.

Enter the FTP Client and go to: **File > Site manager > New Site**. A dialog box requiring obligatory information about the device will appear. Fill in the needed information and press "OK".

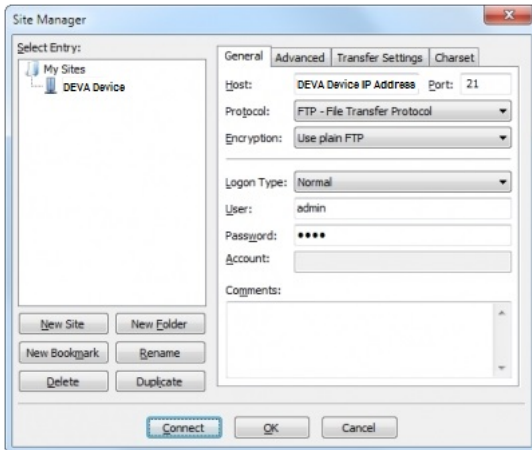

Select "Transfer Settings" sub-menu and apply the settings as shown below:

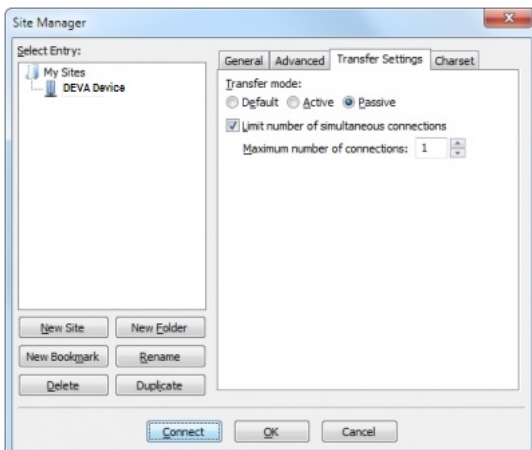

WARRANTY TERMS AND CONDITIONS

I. TERMS OF SALE: DEVA Broadcast Ltd. products are sold with an understanding of “full satisfaction”; that is, full credit or refund will be issued for products sold as new if returned to the point of purchase within 30 days following their receipt, provided that they are returned complete and in an “as received” condition.

II. CONDITIONS OF WARRANTY: The following terms apply unless amended in writing by DEVA Broadcast Ltd.

A. The Warranty Registration Card must be completed and returned to DEVA Broadcast Ltd. within 10 days of delivery. Product registration can also be done digitally at <https://www.devabroadcast.com/members/product-registration>, after registering on our website, within 10 days of delivery.

B. This Warranty applies only to products sold “as new.” It is extended only to the original end-user and may not be transferred or assigned without prior written approval by DEVA Broadcast Ltd.

C. This Warranty does not apply to damage caused by improper mains settings and/or power supply.

D. This Warranty does not apply to damage caused by misuse, abuse, accident or neglect. This Warranty is voided by unauthorized attempts at repair or modification, or if the serial identification label has been removed or altered.

III. TERMS OF WARRANTY: DEVA Broadcast Ltd. products are warranted to be free from defects in materials and workmanship.

A. Any discrepancies noted within TWO YEARS of the date of purchase will be repaired free of charge, or the equipment will be replaced with a new or remanufactured product at DEVA Broadcast Ltd. option.

B. Parts and labor for factory repair required after the two-year Warranty period will be billed at prevailing prices and rates.

IV. RETURNING GOODS FOR FACTORY REPAIR:

A. Equipment will not be accepted for Warranty or other repair without a Return Material Authorization (RMA) number issued by DEVA Broadcast Ltd. prior to its return. An RMA number may be obtained by placing an RMA request at <https://www.devabroadcast.com/rma>. The number should be prominently marked on the outside of the shipping carton.

B. Equipment must be shipped prepaid to DEVA Broadcast Ltd. Damage sustained as a result of improper packing for return to the factory is not covered under terms of the Warranty and may occasion additional charges.

V. UPDATES TO THE TERMS OF SERVICE:

For the most up-to-date, valid, and accurate terms, conditions, and product documentation, please visit the official DEVA Broadcast Ltd. website downloads section at <https://www.devabroadcast.com/downloads/deva-documents>. Printed documents may not reflect recent amendments. Reviewing the current online versions ensures you have the latest information.



PRODUCT REGISTRATION CARD

- All fields are required, or warranty registration is invalid and void

Your Company Name _____

Contact _____

Address Line 1 _____

Address Line 2 _____

City _____

State/Province _____ ZIP/Postal Code _____

Country _____

E-mail _____ Phone _____ Fax _____

Which DEVA Broadcast Ltd. product did you purchase? _____

Product Serial # _____

Purchase date ____ / ____ / ____

Installation date ____ / ____ / ____

Your signature*

*Signing this warranty registration form you are stating that all the information provided to DEVA Broadcast Ltd. are truth and correct. DEVA Broadcast Ltd. declines any responsibility for the provided information that could result in an immediate loss of warranty for the above specified product(s).

Privacy statement: DEVA Broadcast Ltd. will not share the personal information you provide on this card with any other parties.