

MAINTENANCE AND OPERATION
INSTRUCTION MANUAL

RF2IP

Digital RF Power Monitoring Probe
with LAN Connectivity



Contents

Introduction	5
Typographic conventions	6
General Information	7
Product Features	8
<i>Technical Specifications</i>	9
<i>Block Diagram</i>	10
Factory Default Settings	11
<i>How to reset the RF2IP to its factory defaults without having access to the WEB interface?</i>	11
Unpacking and inspection	12
Mounting	12
<i>Rack Requirements 1U</i>	12
<i>Rack Requirements Compact Units</i>	12
<i>Stand-Alone Devices</i>	12
Safety Warning	13
Operating Recommendations	14
Getting Started	15
<i>Connection</i>	15
<i>Network Settings</i>	16
<i>Network Discovery</i>	16
<i>Network Security Recommendations</i>	17
Panel Indicators and Appointments	18
<i>Front Panel</i>	18
<i>Rear Panel</i>	18
<i>Front Panel Alarm Terminal</i>	19
<i>Device Connection</i>	20
Typical Applications	21
<i>Application Example - Radio, using RF2IP Hub</i>	21
<i>Application Example - Radio, using Compact RF2IP Hub</i>	22
<i>Application Example - Television, using RF2IP Hub</i>	23
<i>Application Example - Television, using Compact RF2IP Hub</i>	24
How to configure a connection between the RF2IP Hub and RF2IP Probe	25
<i>WAN Port</i>	25
<i>LAN Port</i>	25
<i>Network Separation Requirement</i>	26
<i>Alternative Setup</i>	26
WEB interface	27
<i>Main</i>	27
<i>Graph</i>	28
<i>Log</i>	29
<i>Status</i>	30
<i>General Settings</i>	31
<i>Alarms</i>	32
<i>Calibration</i>	33
<i>Communication</i>	34
<i>Outputs</i>	36
<i>Other</i>	37

APPENDIX A 38
 Alarm Triggers 38
 Alarm Notifications 40
WARRANTY TERMS AND CONDITIONS..... 41
Product Registration Card..... 42

THIS PAGE
IS INTENTIONALLY
LEFT BLANK

Introduction

DEVA Broadcast Ltd. is an international communications and high-technology manufacturing organization, its corporate headquarters and facility located in Burgas, Bulgaria. The company serves the broadcast and corporate markets worldwide – from consumers and small businesses to the largest global organizations. It is dedicated to the research, design, development and provision of advanced products, systems and services. DEVA launched its own brand back in 1997 and has nowadays evolved to become known as a market leader and internationally reputed manufacturer of user-friendly, cost-effective and innovative broadcast products.

Creativity and innovation are deeply woven into DEVA corporate culture. Through successful engineering, marketing and management our team of dedicated professionals creates future-oriented solutions to improve customers' performance. You may rely that all issues communicated to our crew would be addressed accordingly. We pride ourselves on our pre and post-sales support and purchase services, which along with the outstanding quality of our radio gear have won us due respect and the market authority position.

DEVA best-of-breed solutions have become the best sellers for our partners. The strategic partnerships which have been formed with industry leaders during all these years that we have been operating on the broadcasting market, have proved us a reliable business partner and a valuable asset, as our dealers worldwide would confirm. In constant pursuit of precision and long-term satisfaction, DEVA enhances the reputation of our partners and clients alike. Furthermore, we have already a proven merit as a credible partner provider.

Our portfolio offers complete line of high quality and competitive products for FM and Digital Radio, Radio Networks, Telecommunication Operators and regulation authorities. For almost two decades of intensive software and hardware development, we have achieved a unique price-performance and endurance of our product lines. Our company's multitude of equipment and services is in line with the latest technologies and key trends. The most recognizable characteristics attributed to DEVA products are their clear-cut, streamlined design, easiness of use and cost-effectiveness: simplicity of forms but multiplicity of functions.

For us there is no stage when we deem that we have reached the most satisfactory level in our work. Our engineers are in constant pursuit of new ideas and technologies to be captured in DEVA solutions. Simultaneously, a strict control is being exercised at each step of any new development. Experience and hard work are our fundament but the continuous improving process is what we never leave aside. DEVA participates on a regular basis in all landmark broadcasting events, not only to promote its products, but to exchange valuable know-how and experience. We are also engaged in international large-scale projects involving radio and audio solutions which makes us even more competitive on the global market.

All DEVA products are developed and produced in accordance with the latest ISO 9001 quality control standards.

Typographic conventions

The following table describes important conventions used in the manual.

Convention and Style	Description	Examples
<i>Menu > Sub Menu > Menu Command</i>	A menu item(s) and menu command that you need to click in sequence	Click <i>Settings > General</i>
[Button]	Interface Interactive buttons	Press [OK] to save the changes
NOTE	Important notes and recommendations	NOTE: The notification will appear only once
<u>“Reference Name” on Page XXX</u>	References and links	refer to <u>“New Connection”</u> (see <u>“Monitoring” on page 56</u>)
Example	Used when example text is cited	Example for E-mail Notification: Date: 04 Nov 2013, 07:31:11

General Information

The RF2IP Digital Power Probe is the most cost effective solution on the market for easy monitoring of Forward and Reflected RF Power in a typical directional coupler and combiners installation.

The very high measurement precision and a dynamic range of more than 50dB make this probe the best choice for remote transmission systems measurements. It has been developed for a precise measurement of analog and True Average power for digitally modulated signals.

Top product performance is achieved thanks to the LAN port for full TCP/IP remote control and monitoring, advanced SNMP Ver.2C management and the extremely intuitive embedded WEB server for interactive supervision. It is powered through the LAN cable via PoE (Power over Ethernet) and all calibrations and additional adjustments are performed remotely.

The RF2IP Digital Power Probe comes with easy and flexible real-time monitoring and many other additional features, such as the Factory Parameters Restore option, FTP Server for downloading the measurements log, SNTP for automatic synchronization of the built-in clock, as well as date and time settings in various formats. It supports a variety of transmitter configurations and offers adjustable alarm thresholds for all important parameters. Alarms can be dispatched via E-mail, SNMP Ver.2C and Optically isolated GPO.

Combined with a compact and robust aluminum case, this powerful product delivers dependable round-the-clock operation with guaranteed quality.

RF2IP Digital Power Probe is an SNMP V.2 enabled telemetry tool all in a class of its own.

Product Features

- Dual RF Power ports with built-in precise power sensors
- Adjustable MIN/MAX alarms for FWD Power, RFL Power and VSWR
- Adjustable MIN/MAX alarms for Return-Loss and Crest Factor
- IP-based broadcast control for exceptional scalability
- LAN port for full TCP/IP remote control and monitoring
- Very Intuitive Embedded WEB server for interactive supervision
- Advanced monitoring and full control by SNMP Ver.2C
- Alarm dispatch via E-mail, SNMP and GPO
- Fully DSP based core for a detailed signal analysis
- Attractive price and very good price-performance ratio
- Proved and reliable hardware for 24/7/365 operating
- SNTP for automatic synchronization of the built-in clock
- Compact and Robust Aluminum Case for high RF immunity
- Easy Installation and Setup

TECHNICAL SPECIFICATIONS

USER INTERFACE	
WEB interface	Full monitoring and control; Interactive and easy to use
Indicators	2 LEDs
COMMUNICATION INTERFACES	
Ethernet	10/100 Base-T; RJ45 connector
Protocols	HTTP, SNMP, SMTP, DHCP
NETWORK	
Connector	RJ-45
Type	Ethernet
Device discovery	UPnP support
OTHER	
GPO	3 outputs, Open Collector type
MEASUREMENT STORAGE	
Storage	in Memory
METERING ACCURACY	
RF Level	±2%
FWD POWER INPUT	
Connector	SMA on rear panel
Impedance	50 Ω
Frequency Ranges	FM (87 - 108MHz); DAB/DAB+ (170 - 242MHz); UHF/DVB/DVB-T2 (470 - 860MHz)
Sensitivity	-50dBm to +10dBm
Readings units	dBm, W
REFELCTED POWER INPUT	
Connector	SMA on rear panel
Impedance	50 Ω
Frequency Ranges	FM (87 - 108MHz); DAB/DAB+ (170 - 242MHz); UHF/DVB/DVB-T2 (470 - 860MHz)
Sensitivity	-50dBm to +10dBm
Readings units	dBm, W
OPERATING CONDITIONS	
Temperature	-15°C to 55°C
Humidity	< 95%, non-condensing
Altitude	0 to 5000m above sea level
EMC immunity	6V/m
POWER REQUIREMENT	
Power supply	48V/0.3A PoE via PoE Switch or via PoE power injector (Not Included)
Power consumption	10W
Connector	RJ45/LAN
SIZE AND WEIGHT	
Dimensions (W;H;D)	86 x 25 x 125 mm
Shipping Weight	230 x 70 x 172 mm / 0.533 kg

BLOCK DIAGRAM

A simplified block diagram of RF2IP is shown below

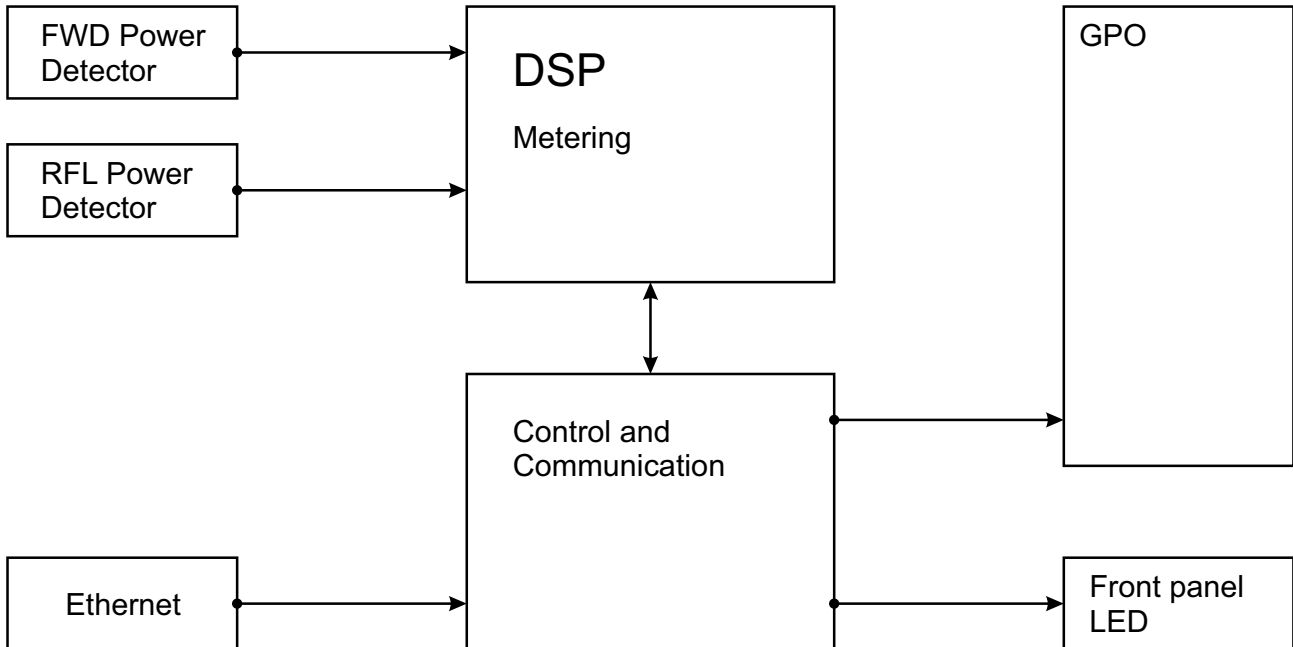

Because of the all-digital, minimalist-discrete-component nature of device circuitry, we have not provided schematic diagrams of the RF2IP in this Manual. Please, note that:

**NO USER-SERVICEABLE COMPONENTS INSIDE.
REFER ALL SERVICING TO
QUALIFIED TECHNICAL PERSONNEL.**

Factory Default Settings

HOW TO RESET THE RF2IP TO ITS FACTORY DEFAULTS WITHOUT HAVING ACCESS TO THE WEB INTERFACE?

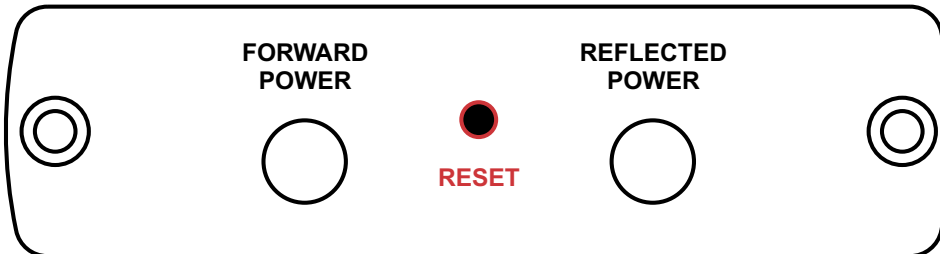

1. Disconnect the power supply cable from the unit.
2. Find the RESET button on Rear panel (labeled in red on the picture), press and hold it.
3. While pressing the RESET button, connect the power supply cable to the unit and wait until the POWER led starts blinking.
4. Release the RESET button and wait for the RF2IP to reboot.
5. Once the reboot is complete, the RF2IP will be returned to its factory default settings.

Unpacking and inspection

Upon receipt, the equipment should be inspected for possible shipping damages. If such are found or suspected, notify the carrier at once and contact DEVA Broadcast Ltd. The original shipping carton box and packing materials should be kept for possible reuse, in case of return for Warranty repair, for example. Shipping damages as a result of improper packing for return may invalidate the Warranty!

The packing material (plastic bags, polystyrene, nails, etc.) must never be left within reach of children, as these items are potential sources of danger.

IT IS VERY IMPORTANT that the [“Product Registration Card”](#) included in the Manual be completed accurately and returned. This will assure coverage of the terms of the Warranty and it will provide a means of trace in case of lost or stolen equipment. In addition, the user will automatically receive SERVICE OR MODIFICATION INSTRUCTIONS from DEVA Broadcast Ltd.

Mounting

RACK REQUIREMENTS 1U

The unit mounts in a standard 19-inch equipment rack and requires only 1 $\frac{3}{4}$ inches (1U) of vertical rack space. In order the painted finish around the mounting holes to be protected, the use of plastic washers is recommended.

RACK REQUIREMENTS COMPACT UNITS

Our customized 1U 19-inch rack accessory provides a professional mounting option for up to three compact size DEVA units. It is made of milled aluminum and finished in black powder coat. Two extra blanking panels and set of mounting screws are provided with each rack bracket kit.

STAND-ALONE DEVICES

DEVA's stand-alone units (Radio Explorer series, BandScanner series, DVB Explorer) do not require additional tools or installation brackets.

Safety Warning

ALWAYS OBSERVE THE SAFETY PRECAUTIONS.

Careful observance of the safety precautions will help prevent physical injury, damage of the equipment, and extend the equipment life.

- The servicing of electronic equipment should be performed only by qualified personnel;
- Before removing the covers the unit must be switched off and the mains cable unplugged;
- When the equipment is open, the power supply capacitors should be discharged using a suitable resistor;
- Never touch the wires or the electrical circuits;
- Use insulated tools only;
- Never touch the metal semiconductor. They might carry high voltages;
- For removing and installing electronic components, follow the recommendations for handling MOS components.
- Do not remove the factory sticker from the equipment. It contains information as regards the name, serial number and MAC address of the device.
- To join the equipment to the mains supply, use the power cord purchased with the equipment.

Operating Recommendations

To ensure normal operation of the DEVA unit, we recommend following the instructions listed below.

- Install the unit in places with good air conditioning. The unit is designed to operate within the ambient temperature range of 10 to 50°C. The equipment rack should be ventilated in order for the device to keep its internal temperature below the maximum ambient temperatures;
- We do not recommend installation in rooms with high humidity, dusty places or other aggressive conditions;
- Although the device is intended to be installed closed to exciters or transmitters, we do recommend the device to be located away from abnormally high RF fields.
- Use only checked power supply cables. We strongly recommend the usage of shielded cables;
- Connect the DEVA unit to reliable power supply sources only. In case of unstable power supply, please use Uninterruptible Power Supply (UPS);
- Use the device only with its top cover on to avoid electromagnetic anomalies. Otherwise, this may cause problems with the normal functionality of the unit;
- To ensure normal remote operation of the unit, make sure to connect the device to a good quality Internet connection;
- For the normal operation of your DEVA device, check if the network settings past through all the required data traffic.

Getting Started

In order for the normal operation of the RF2IP to be guaranteed, you will need fulfill the following conditions:

1. Standard Ethernet 10/100M connection;
2. Correctly assigned Network configuration and device settings.

To make sure that all the conditions are fulfilled please, follow the instructions below.

CONNECTION

1. Install the unit on its operation place;
2. Using the provided power cable, connect the unit to the power supply network;
3. Connect the antenna cable to the RF antenna input connector located on the rear panel of the device;
4. Connect the RF2IP to the TCP/IP network using direct network cable;
5. **IF GSM OPTION IS SUPPORTED** - Using the connection cable provided, connect the optional GSM modem. In order for better GSM network coverage to be achieved, please select proper place for the GSM antenna.

NOTE: The GSM antenna must be installed far enough from the monitoring devices. The GSM modem radiates RF signal that may cause spurious emissions that will may interfere with the accuracy of the measurements.

NETWORK SETTINGS

After connecting the network cable the Led 'LAN' located on the rear panel must be ON or flashing. The next and most important step for configuration is the adjustment procedure of the Network Communication. The settings shown below are Default Network Settings:

DHCP	Enabled
IP	Assigned by DHCP
Mask	Assigned by DHCP
Gateway	Assigned by DHCP
DNS	Assigned by DHCP
HTTP Port	80

NETWORK DISCOVERY

This is a network setting that defines whether your computer can see (find) other computers and devices on the network and whether other computers on the network can see your computer. By default, Windows Firewall blocks network discovery but you can enable it.

1. Open Advanced sharing settings by clicking the Start button, and then on "Control Panel". In the search box, type "network", click "Network and Sharing Center", and then, in the left pane click "Change advanced sharing settings";
2. Select your current network profile;
3. Click "Turn on network discovery", and then click save changes.

NOTE: If you're prompted for an administrator password or confirmation, type the password, provide confirmation or contact your system administrator.

If you have already enabled this function on your computer RF2IP will be automatically added to the Device list section. The device will be ready for usage and no additional adjustments will be required except user name and password.

NOTE: If the port is different than the default one (80), it is necessary to specify it, for example:
`http://192.168.1.2:9000`

ATTENTION: Depending on Internet Protocol Settings, the assigned IP address may not be visible outside your local network, thus the device may be accessed only within that network. Consult with your network administrator for the appropriate IP settings.

NETWORK SECURITY RECOMMENDATIONS

1. It is not recommended the RF2IP to be directly connected to the Internet. This may lead to unregulated access and/or problematic operation of the device. To ensure secure connection, we recommend the device to be installed behind a router with an active firewall.
2. If remote access to the device is needed, we recommend using VPN to the router or the port of the relevant service (WEB, SNMP, Application, etc.) to be properly NAT forwarded.
3. If NAT forward is used, it is highly recommended random ports of your choice to be used. Not the standard ones (80 for WEB, 161 for SNMP, etc.).
4. Using DMZ connection is not recommended.
5. Make sure to change the standard access credentials (usernames and passwords, SNMP communities).

For detailed information as regards the recommendations listed above or need of further instructions, please contact your network administrator.

Panel Indicators and Appointments

FRONT PANEL



GPO – 3 General Purpose Outputs, Open Collector Type

PWR – Power LED Indicator

LAN – LAN LED Indicator. This LED can be in one of the following states:

Off - No User Connected;

Blinking – User is connected;

LAN Port / Internet Input – standard RJ-45 port

REAR PANEL

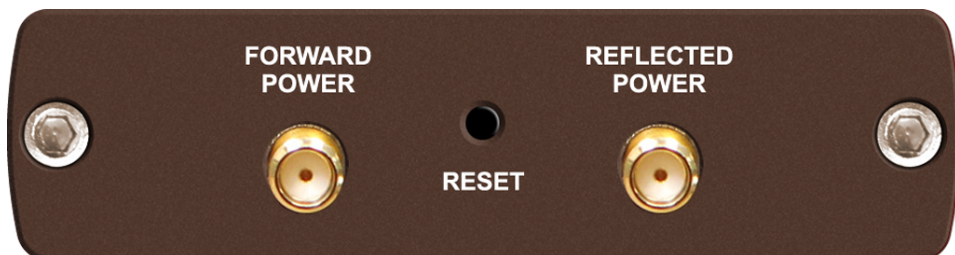

FORWARD POWER – SMA connector for Forward Power

RESET – Factory Defaults reset button

REFLECTED POWER – SMA connector for Reflected Power

FRONT PANEL ALARM TERMINAL

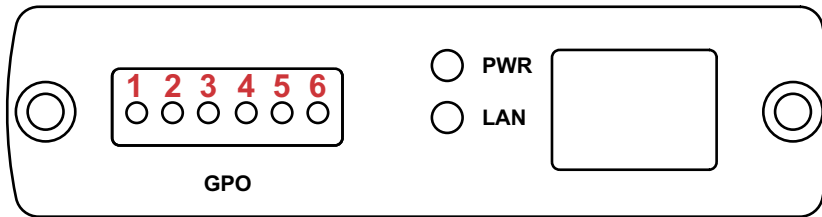

- 1 - GPO1 Emitter
- 2 - GPO1 Collector
- 3 - GPO2 Emitter
- 4 - GPO2 Collector
- 5 - GPO3 Emitter
- 6 - GPO3 Collector

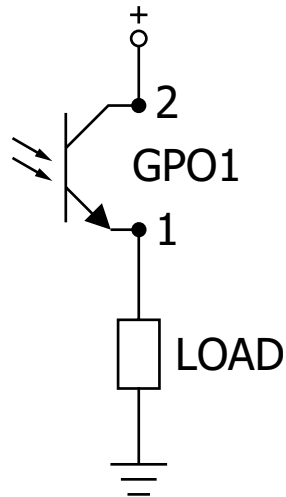
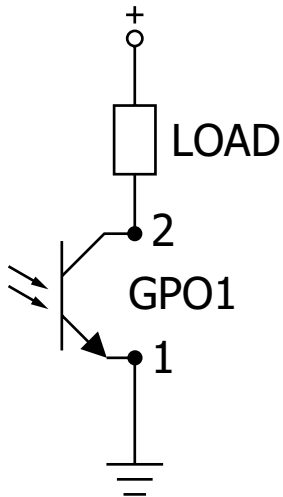

DEVICE CONNECTION

The RF2IP unit is powered by POE over the LAN Cable. It is very important, when the initial connection is made, the POE 802.3 AF standard to be observed. Having that in mind, make sure that the POE supplies 48 volts.

Typical Applications

APPLICATION EXAMPLE - RADIO, USING RF2IP HUB

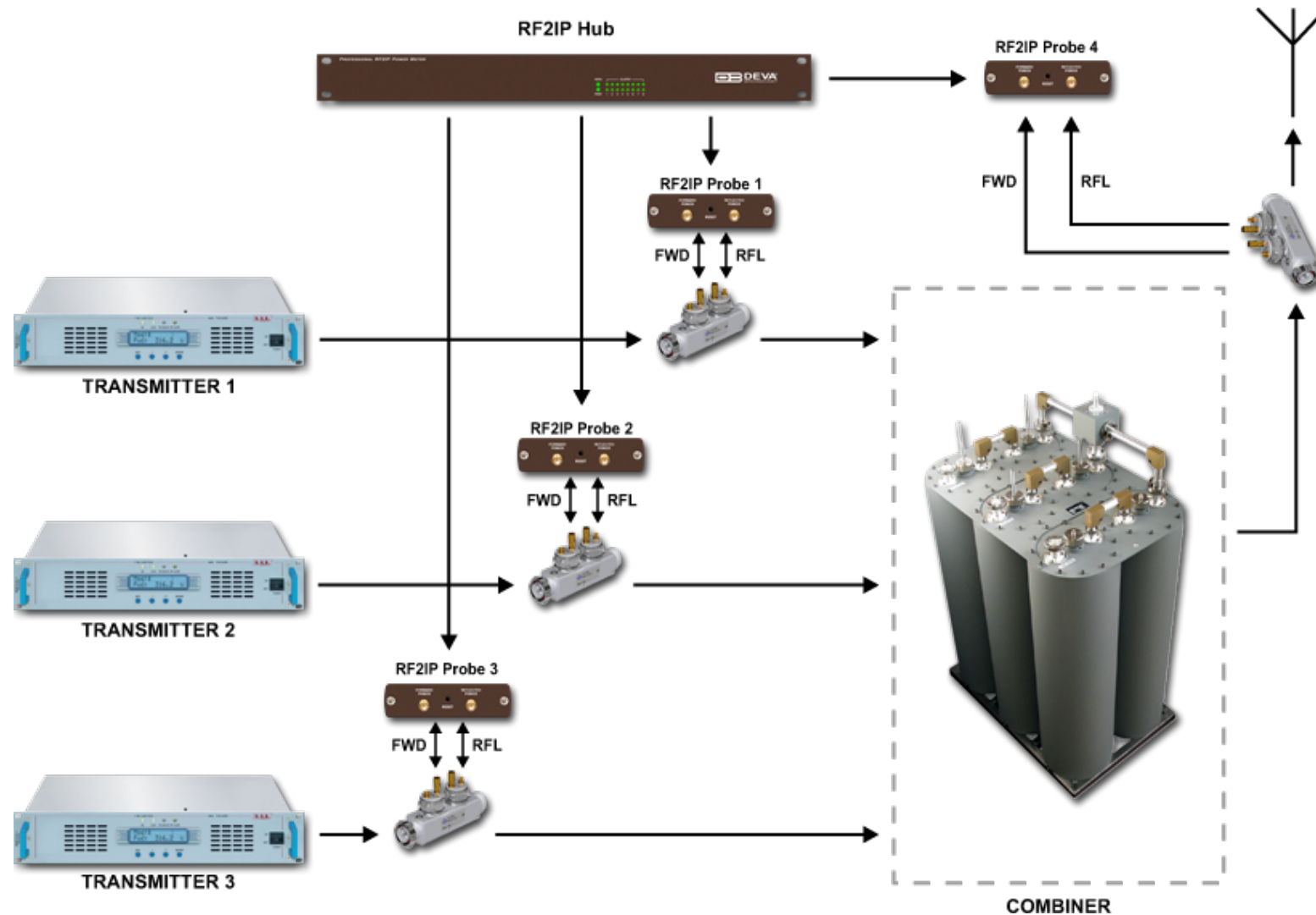

APPLICATION EXAMPLE - RADIO, USING COMPACT RF2IP HUB

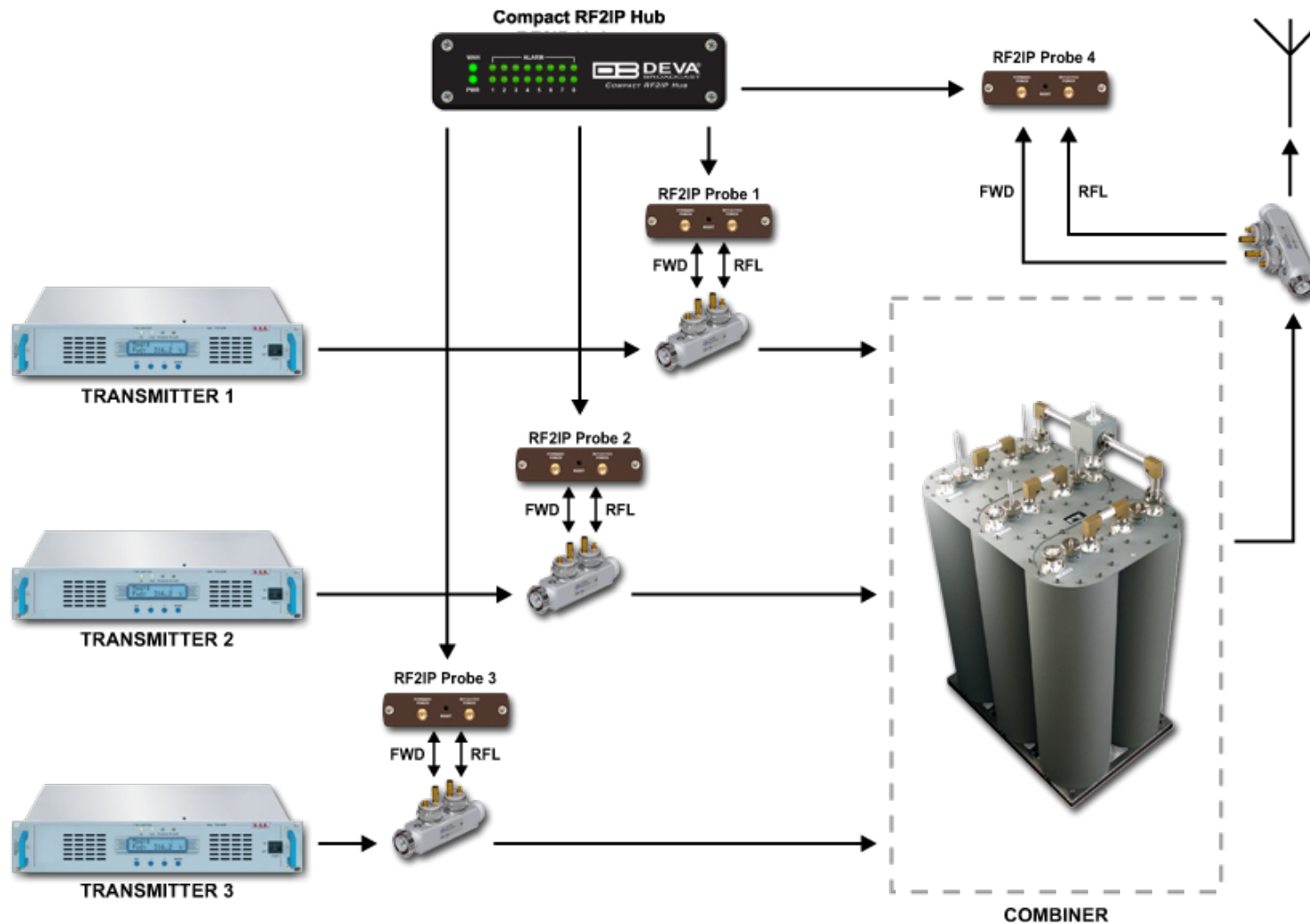

APPLICATION EXAMPLE - TELEVISION, USING RF2IP HUB

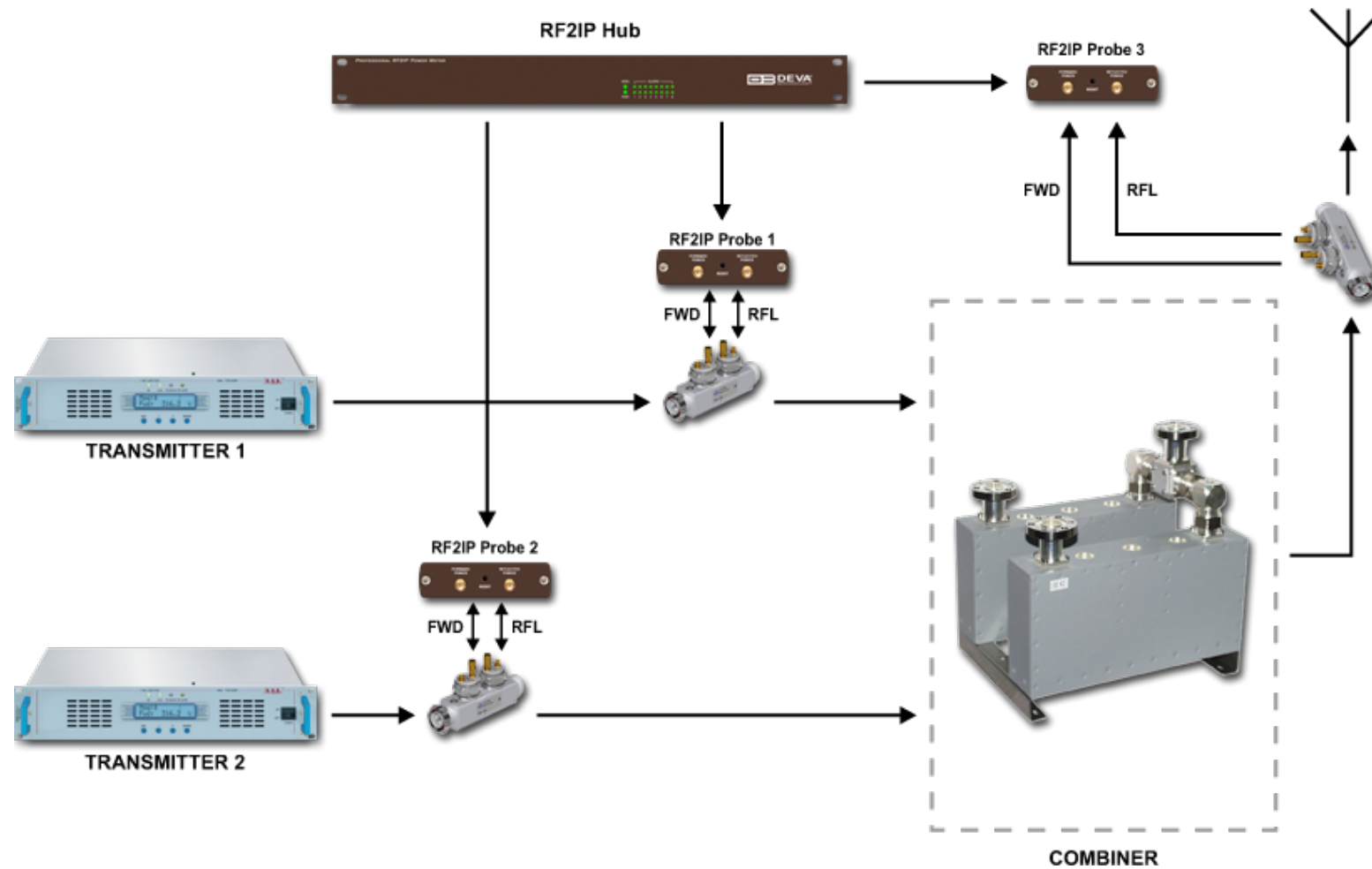

APPLICATION EXAMPLE - TELEVISION, USING COMPACT RF2IP HUB

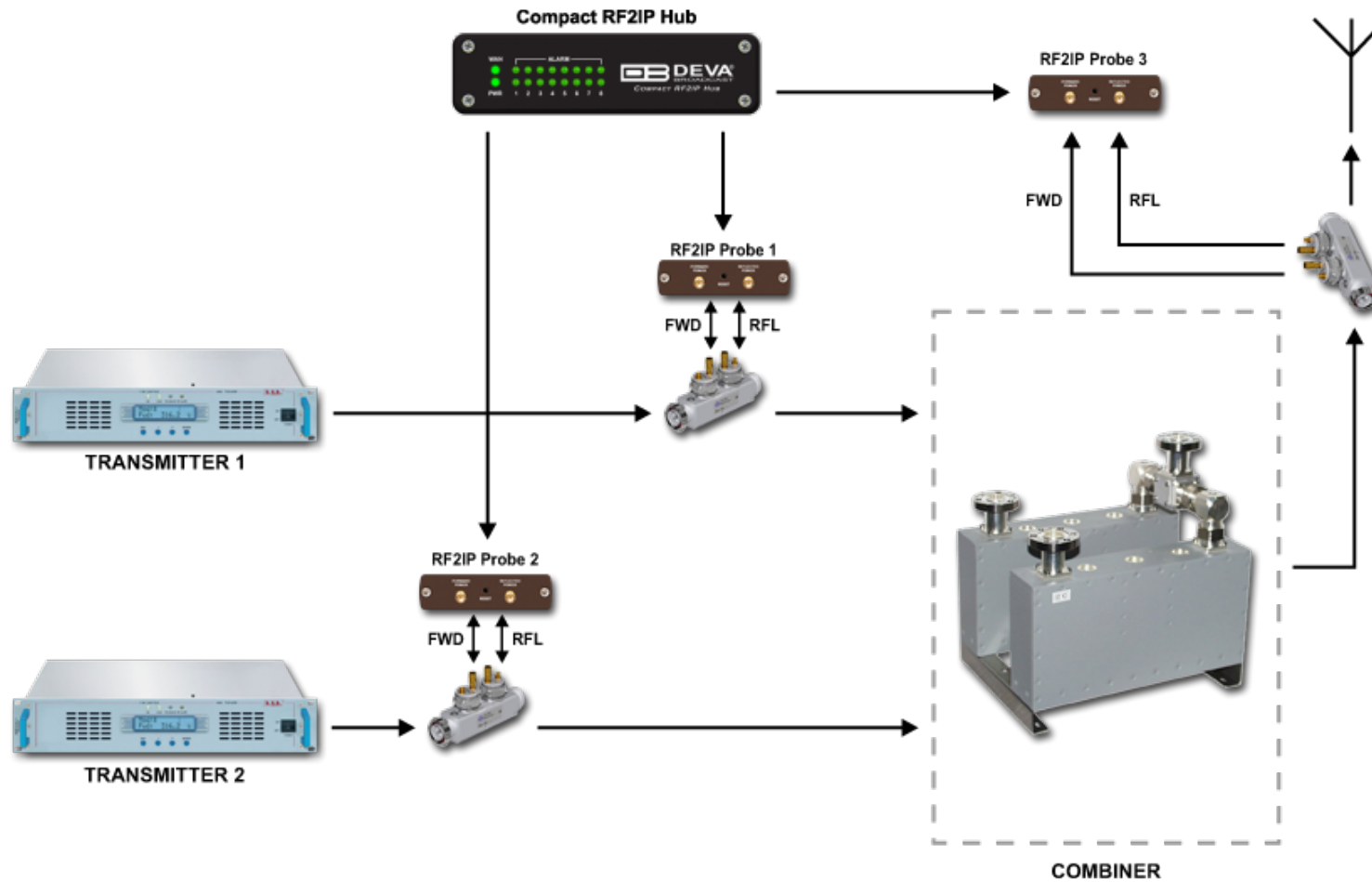

How to configure a connection between the RF2IP Hub and RF2IP Probe

To ensure proper communication between the RF2IP Hub and the connected probes, it is important to configure the network settings correctly. The device features two network interfaces: a WAN port for hub access and control, and a LAN port for managing probes. Each port serves a distinct purpose and must be set up according to the recommendations below to guarantee stable and reliable operation.

A detailed description of each port and its configuration is provided below:

WAN PORT

By default, the WAN port has a **DHCP client enabled** and can be connected to the internet or a local network.

It is used to **access and control the RF2IP Hub**. The WAN port **must be connected to a network with an active DHCP server**, which will automatically assign an IP address to the device.

This IP address can be discovered using the **UPnP (Universal Plug and Play)** functionality available in Windows.

LAN PORT

The LAN port is used to **manage the probes**. By default, it has a **static IP address** (192.168.12.x / 255.255.255.0) and runs a **basic DHCP server**.

However, this DHCP server assigns **new (random) IP addresses** to probes after every device restart, which can lead to communication issues.

For reliable operation, we **strongly recommend assigning static IP addresses** to all probes within the **same subnet as the LAN port**.

IMPORTANT NOTE: All RF2IP probes must be connected to the LAN port via a **dedicated PoE switch** that serves only the LAN network – specifically, the **LAN port of the RF2IP Hub and the RF2IP probes**.

Example:

```
Probe 1 IP: 192.168.12.10 Mask: 255.255.255.0
Probe 2 IP: 192.168.12.11 Mask: 255.255.255.0
Probe 3 IP: 192.168.12.12 Mask: 255.255.255.0
Probe 4 IP: 192.168.12.13 Mask: 255.255.255.0
Probe 5 IP: 192.168.12.14 Mask: 255.255.255.0
Probe 6 IP: 192.168.12.15 Mask: 255.255.255.0
Probe 7 IP: 192.168.12.16 Mask: 255.255.255.0
Probe 8 IP: 192.168.12.17 Mask: 255.255.255.0
```

NETWORK SEPARATION REQUIREMENT

It is crucial that the **WAN and LAN ports are configured in separate networks**. If both ports are assigned IP addresses in the same subnet, the device may become inaccessible, requiring a **hardware or factory reset** to restore connectivity.

ALTERNATIVE SETUP

Probes can also be connected to the **same network as the WAN port**. In this setup, they will be **accessible from outside the local network**, but **cannot be managed directly by the HUB**.

You will still be able to access each probe individually via its **IP address using a web browser**.

WEB interface

MAIN

The RF2IP provides you with a protected access to the device settings. The device serves only one user at a time, thus username and password will be requested when login. Default values are *admin* and *pass*. Upon successful log-in, the Main window will look as follows:

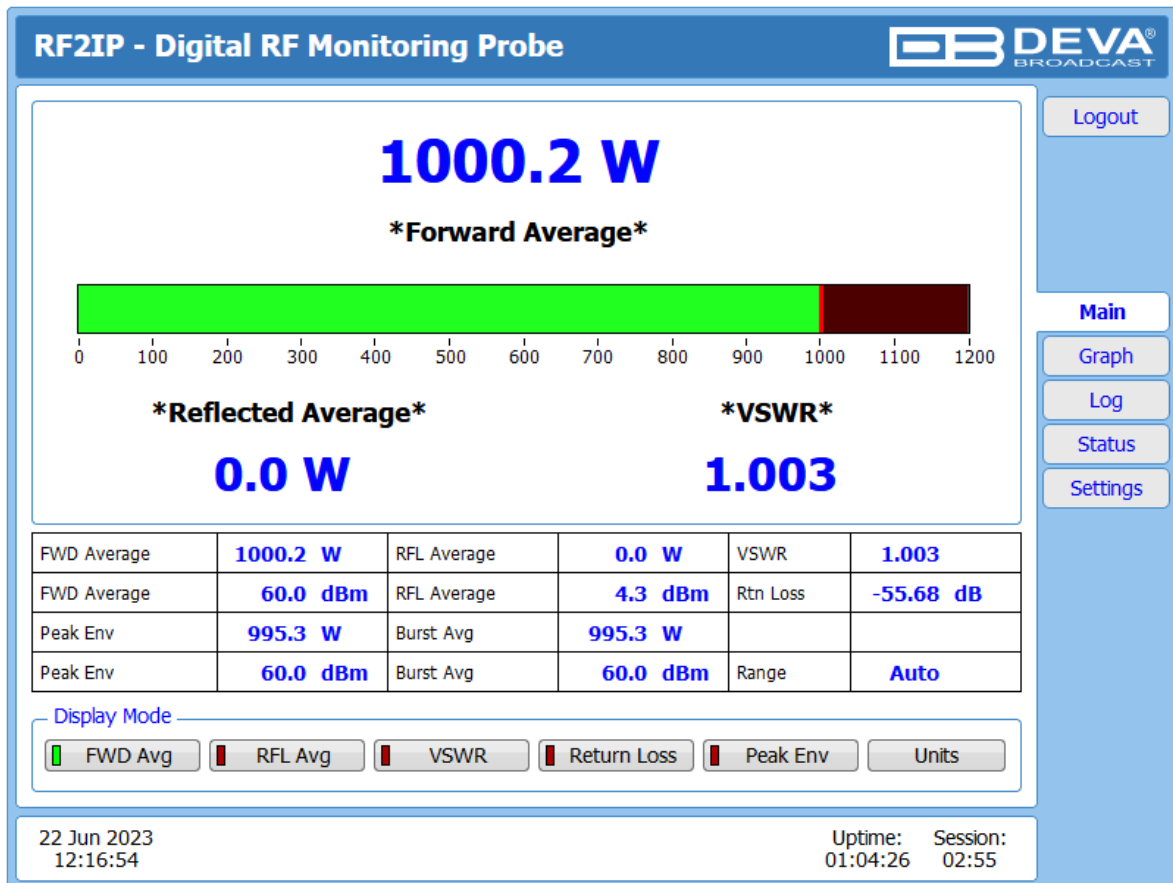

The RF2IP has two inputs and measures both the forward and the reflected power.

1. Forward – measures the power fed to the antenna system;
2. Reflected – measures the reflected (returned) power from the antenna system.

Depending on the selected Display Mode, the Main Screen of the WEB Interface can show the Forward Average, Reflected Average, VSWR, Return Loss or Peak Env parameters represented as bargraph readings. The units to be used are easily changed via the [Units] interactive button.

Following the easy to read manner of presentation, a table containing all the needed information in both W and dBm units is also available.

GRAPH

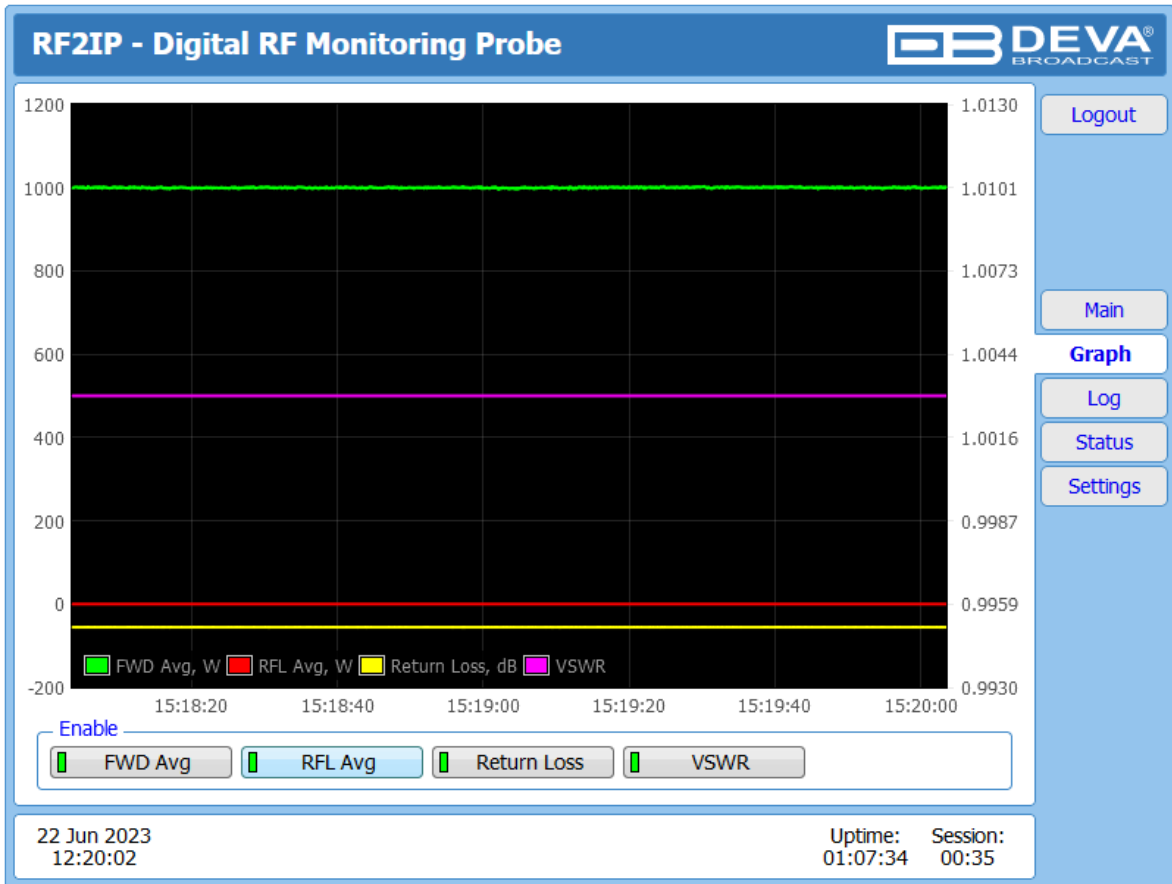

The Graphs page represents the value deviation of measured parameters in time. All the parameters are color coded and can be enabled or disabled depending on the preferences.

LOG

RF2IP - Digital RF Monitoring Probe

Clear System Log

Reload

2023-06-22 11:12:23	System	System Reboot Request (if available)
2023-06-22 11:12:31	System	Device is powered up (reboot)
2023-06-22 11:12:41	Alarm	98.00MHz, Forward Average < 18.0kW (0.4kW)
2023-06-22 11:12:49	Control	WEB Login, 192.168.20.192, Admin
2023-06-22 11:13:23	Alarm Idle	98.00MHz, Forward Average OK [600.0 to 1100.0]W (2995.4W)
2023-06-22 11:13:34	Alarm	98.00MHz, Forward Average < 600.0W (365.7W)
2023-06-22 11:14:13	Alarm Idle	98.00MHz, Forward Average OK [1.80 to 3.30]kW (4.84kW)
2023-06-22 11:14:24	Alarm	98.00MHz, Forward Average > 3.30kW (4.83kW)
2023-06-22 11:14:47	Alarm Idle	98.00MHz, Forward Average OK [600.0 to 1100.0]W (1000.1W)
2023-06-22 11:23:00	Control	WEB Logout, 192.168.20.192
2023-06-22 11:23:02	Control	WEB Login, 192.168.20.192, Admin
2023-06-22 11:26:02	Control	WEB Logout, 192.168.20.192
2023-06-22 11:26:03	Control	WEB Login, 192.168.20.192, Admin
2023-06-22 11:32:36	Control	WEB Logout, 192.168.20.192
2023-06-22 11:32:38	Control	WEB Login, 192.168.20.192, Admin
2023-06-22 11:35:40	Control	WEB Logout, 192.168.20.192
2023-06-22 11:35:41	Control	WEB Login, 192.168.20.192, Admin
2023-06-22 11:38:52	Control	WEB Logout, 192.168.20.192
2023-06-22 11:38:55	Control	WEB Login, 192.168.20.192, Admin
2023-06-22 11:40:39	Control	WEB Logout, 192.168.20.192
2023-06-22 11:47:46	Control	SNMP Activity, 192.168.20.133:162
2023-06-22 11:50:49	Control	SNMP Activity, 192.168.20.133:162
2023-06-22 12:16:50	Control	WEB Login, 192.168.20.153, Admin

22 Jun 2023
12:20:26

Uptime: 01:07:57 Session: 02:57

Here are listed all the Device System Events. The local measurements and logs are saved in RF2IP's volatile memory and are automatically deleted upon power loss.

[Clear] – will delete all the gathered data.

[Reload] – will refresh the data.

STATUS

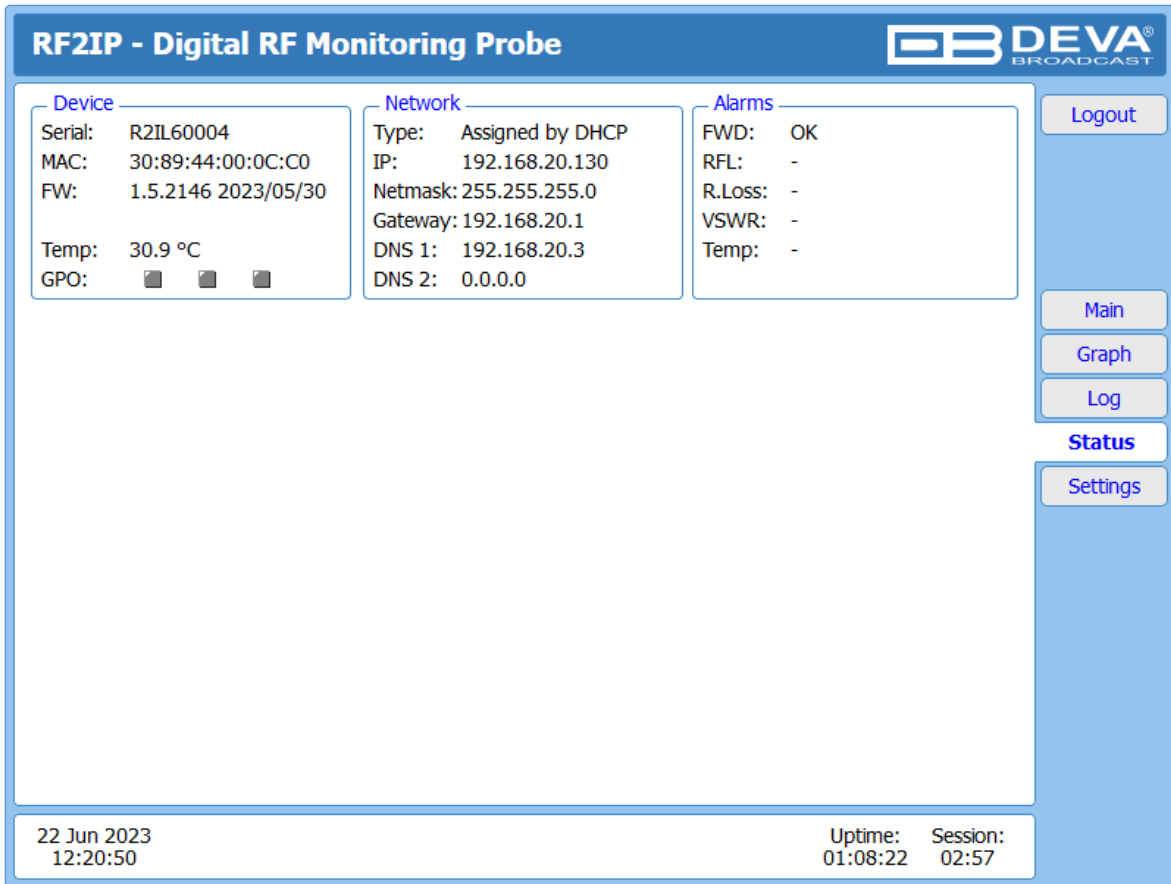

RF2IP - Digital RF Monitoring Probe

Device

Serial:	R2IL60004
MAC:	30:89:44:00:0C:C0
FW:	1.5.2146 2023/05/30
Temp:	30.9 °C
GPO:	<input type="checkbox"/> <input type="checkbox"/> <input type="checkbox"/>

Network

Type:	Assigned by DHCP
IP:	192.168.20.130
Netmask:	255.255.255.0
Gateway:	192.168.20.1
DNS 1:	192.168.20.3
DNS 2:	0.0.0.0

Alarms

FWD:	OK
RFL:	-
R.Loss:	-
VSWR:	-
Temp:	-

Logout

Main

Graph

Log

Status

Settings

22 Jun 2023 12:20:50

Uptime: 01:08:22 Session: 02:57

The status tab shows the alarm status of the RF2IP, along with the basic device and network status (IP address, MAC, etc.).

GENERAL SETTINGS

RF2IP - Digital RF Monitoring Probe Configuration

Security

User: admin User: user
Pass: ●●●● Pass: ●●●●

General

Alias: RF2IP

Date & Time

Date: [] Time: [] Copy Local Time
Time zone: UTC DST: Not Used

SNTP Internet Time

Enable: Enabled Disabled
Server: pool.ntp.org Server Port: 123

Temperature Alarm

Range: 0 °C 80
Thresholds: Low 20 High 70
Trigger time: 05:00 min Release time: 05:00 min
Email SNMP GPO

Save

22 Jun 2023 12:21:16 Uptime: 01:08:47 Session: 02:56

RF2IP provides you with protected access to the device settings. You can choose between two types of log in.

- As an Administrator – It will give you full control over the settings of the device;
- As a User – that will allow you to just monitor the device and to choose different stations, while the Settings bar remains locked.

In order for the security of RF2IP to be enhanced, a new username and password could be set from the Security section. By choice, you can change the name of the device (General section). Later on, it will be used as a title name for all WEB pages. Customizing the name will make the device more recognizable.

Date & Time – used for manually set the current Date and Time. [Copy Local Time] button will set the Date and Time to correspond to that of your computer. Time zone and DST can also be set.

SNTP Internet Time – Synchronizes automatically the RF2IP clock to a millisecond with the Internet time server. Enable this function in order to use it. (Specifying the server closest to your location will improve the accuracy).

Temperature Alarm - Detects abnormal temperature of the equipment. Define the parameters under which a temperature alarm should be generated. The following notification options are available - Email, SNMP or GPO.

NOTE: In order for the applied settings to be used press the [Save] button, placed on the bottom right part of the screen.

ALARMS

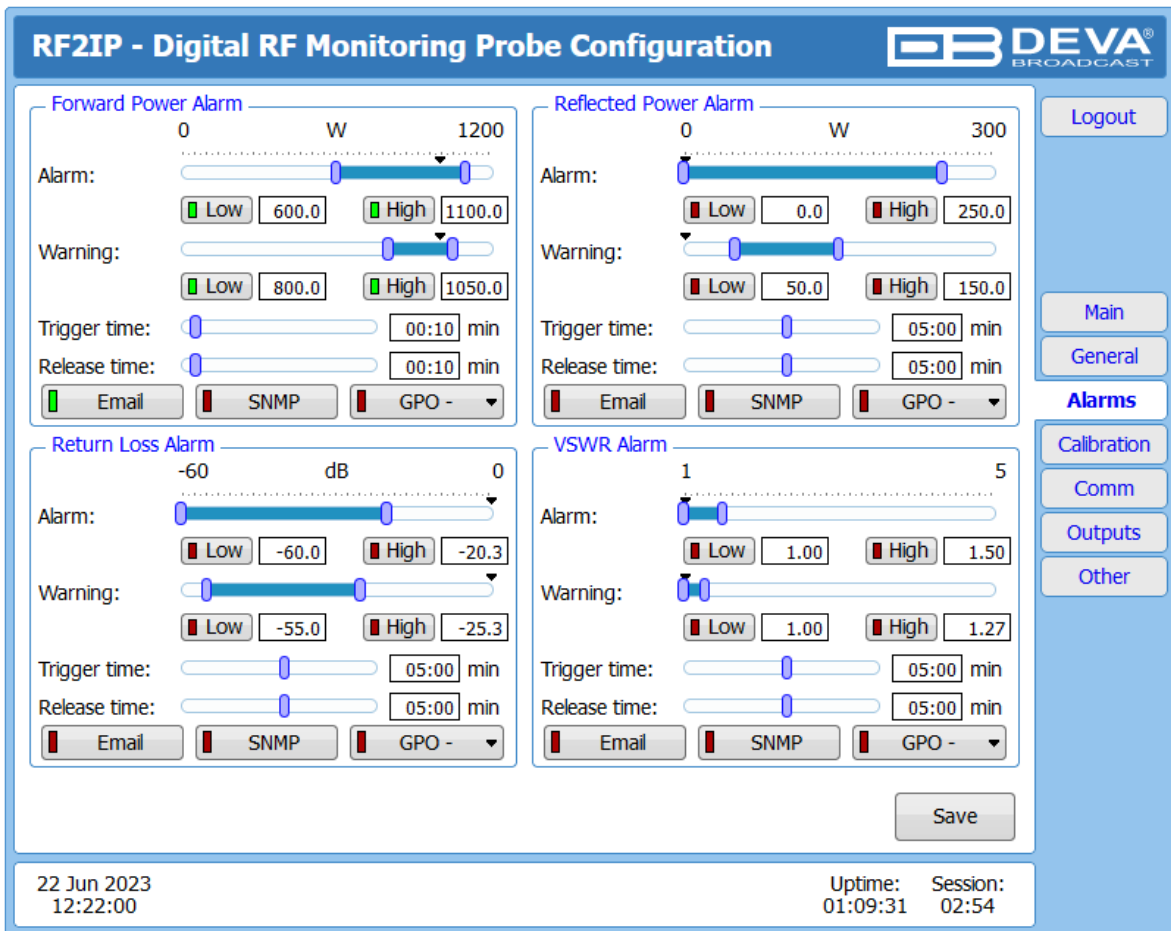

RF2IP has a set of the 4 parameters that can be monitored: Forward Power, Reflected Power, Return Loss and VSWR. Trigger and alarm release times can be set for each alarm. The notification means (Email, SNMP and GPO) is set for each parameter individually. To enable the notification, press on the relevant button so that it could be illuminated in green.

- **Alarm Range** – interactive slider used to adjust the Low & High thresholds at which an alarm will be generated;
- **Warning Range** – interactive slider used to adjust the Low & High thresholds at which a warning will be generated;
- **Trigger Time** – waiting time before Active Alarm/Warning is generated;
- **Release Time** – waiting time before Idle Alarm/Warning is generated;

Trigger and **Release times** define the time, which should elapse in order for the received signal to be defined as low/high/lost or restored/OK. What we recommend is the **Release time** to be bigger than the **Trigger time**.

HAVE IN MIND that the Low and High range is relative to the set expected power in section Calibration.

NOTE: When setting **Trigger** and **Release times**, have in mind that 01:00 means 1 minute, and 00:01 means 1 second.

NOTE: In order for the applied settings to be used press the [Save] button, placed on the bottom right part of the screen.

CALIBRATION

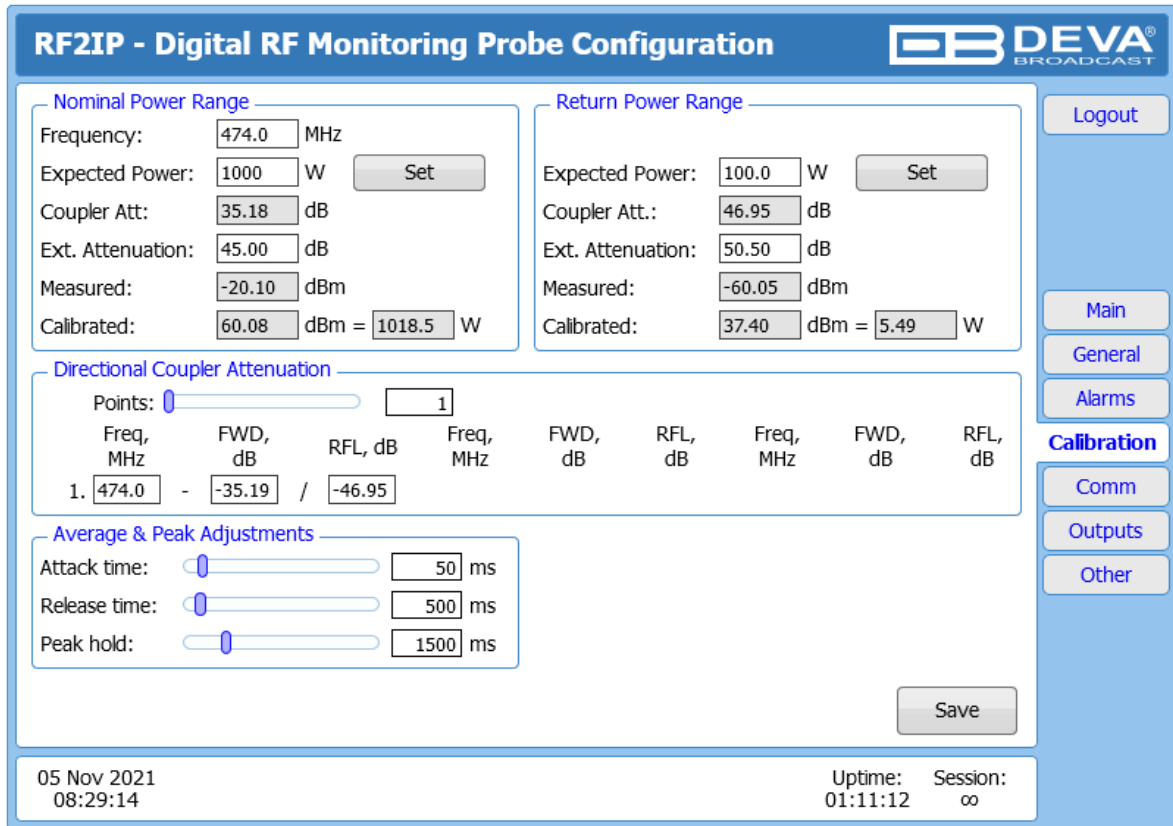

All the needed calibration settings to be applied are available here.

Nominal Power Range

Frequency – sets the frequency of the measured signal, in MHz

Expected Power – sets the expected power, in W

Calibrated – the final (calibrated) measurement is a sum of input measurement (Measured), External Attenuation (the sum of cables' and connectors' losses, and any additional attenuators) and directional coupler attenuation.

External Attenuation – usually the value is not exactly known. Once the signal is connected, set the Expected Power and press the [Set] button. The actual external attenuator will be automatically calculated and filled in the field.

Return Power Range

The same rules as in section **Nominal Power Range** (except for **Frequency**) are applicable.

Directional Coupler Attenuator

This is the setting that specifies the **Coupler Attenuation** field in reference with the set frequency. Specify the number of points and fill the fields with the respective information that can be found in the test sheet or passport of the **Directional Coupler**.

IMPORTANT NOTE: If the details of the **Directional Coupler** are not known, set the number of points to zero and refer to the External Attenuator setting described above.

NOTE: In order for the applied settings to be used press the [Save] button, placed on the bottom right part of the screen.

COMMUNICATION

RF2IP - Digital RF Monitoring Probe Configuration

Network

Enable: Enabled

DHCP: Enabled Disabled

IP Address:

Netmask:

Gateway:

Primary DNS:

Sec. DNS:

Network Status

MAC: 30:89:44:00:0C:C0

IP Type: Assigned by DHCP

IP: 192.168.020.130

Netmask: 255.255.255.000

Gateway: 192.168.020.001

DNS 1: 192.168.020.003

DNS 2: 000.000.000.000

SNMP Agent

Agent: Enabled Disabled

Agent Port:

Agent ses. time: min

Agent ID:

Read Community:

Write Community:

Manager IP:

Manager Port:

SNMP MIB File:

E-mail

Enable: SMTP DEVA Disabled

E-mail 1:

E-mail 2:

Sender:

Username:

Password:

Host name:

Connection:

Server:

Server Port:

HTTP Server

Enable: Enabled

Server Port:

Session time: min

▲ - These settings require reboot.

22 Jun 2023
12:25:59

Uptime: 01:13:31
Session: 02:58

Network

The network addresses could be set manually (static IP) or automatically via a DHCP server. To set static IP, MASK, GATEWAY and DNS addresses, the DHCP should be disabled. In order for the built-in DHCP client to be activated, the function should be enabled. When the DHCP client is activated, all assigned values will be shown in the relevant fields on the Status Screen. If due to any reason, the DHCP procedure cannot be completed, RF2IP will use AutoIP and will generate an IP Address.

Network Status

Information on the current Network Status can be found here.

HTTP Server

[Enabled] the HTTP Server. Specify the Server Port and session timeout. If the [Enabled] button is not illuminated in green, the option is disabled.

SNMP Agent

Agent – [Enabled]/[Disabled] the SNMP Agent.

Specify Agent ID, Agent Port, Read/Write Communities, Manager IP, Manager Port and session timeout. Agent ID is used for identification of the device among others, when an SNMP notification is being sent.

Once all needed settings are applied, use the [Test] button to generate a test notification, which upon success will be received by the SNMP Manager.

Press the [Download] button to download the latest available RF2IP SNMP MIB file.

NOTE: The MIB file may vary from one firmware revision to another. Downloading this file from the device, guarantees that you have the proper MIB file.

E-mail

To use the email notification option, please make sure it is [Enabled] by pressing the relevant button. Then follow the instructions below:

1. Enter the desired alarm recipients in E-mail 1 and/or E-mail 2 fields.
2. Fill in your E-mail account settings: Sender, Username and Password, Server, SNMP port and connection type.
3. It is mandatory the type of connection with the server to be specified from Connection - Regular, Encrypted.
4. The Server port will be changed accordingly. Please note that the most commonly used port will be entered in the field. If the port that is to be used is different, change it manually to the correct value.
5. We recommend you to use the [Test] button and generate a test e-mail, which upon success will be delivered to the specified E-mail 1 and/or E-mail 2. Example of Test E-mail Message:

```
RF2IP Test Message.  
Please do not reply to this e-mail.
```

If you experience difficulties in the set-up, or would like to use DEVA account for sending of alarm email notifications, press the [DEVA] button option, and:

1. Complete the recipient emails (E-mail 1 and E-mail 2) only.
2. The other fields must be left blank, otherwise the email notification option will not be working.
3. We recommend you to use the [Test] button and generate a test e-mail, which upon success will be delivered to the specified E-mail 1 and/or E-mail 2. Example of Test E-mail Message:

```
RF2IP Test Message.  
Please do not reply to this e-mail.
```

Even though using the DEVA account eases the set-up process, we recommend user account to be used for sending of email notifications, and the DEVA account for test purposes. When using DEVA account, please note that the stable 24/7 connection depends on the mail service provider and cannot be guaranteed.

NOTE: In order for the applied settings to be used press the [Save] button, placed on the bottom right part of the screen.

OUTPUTS

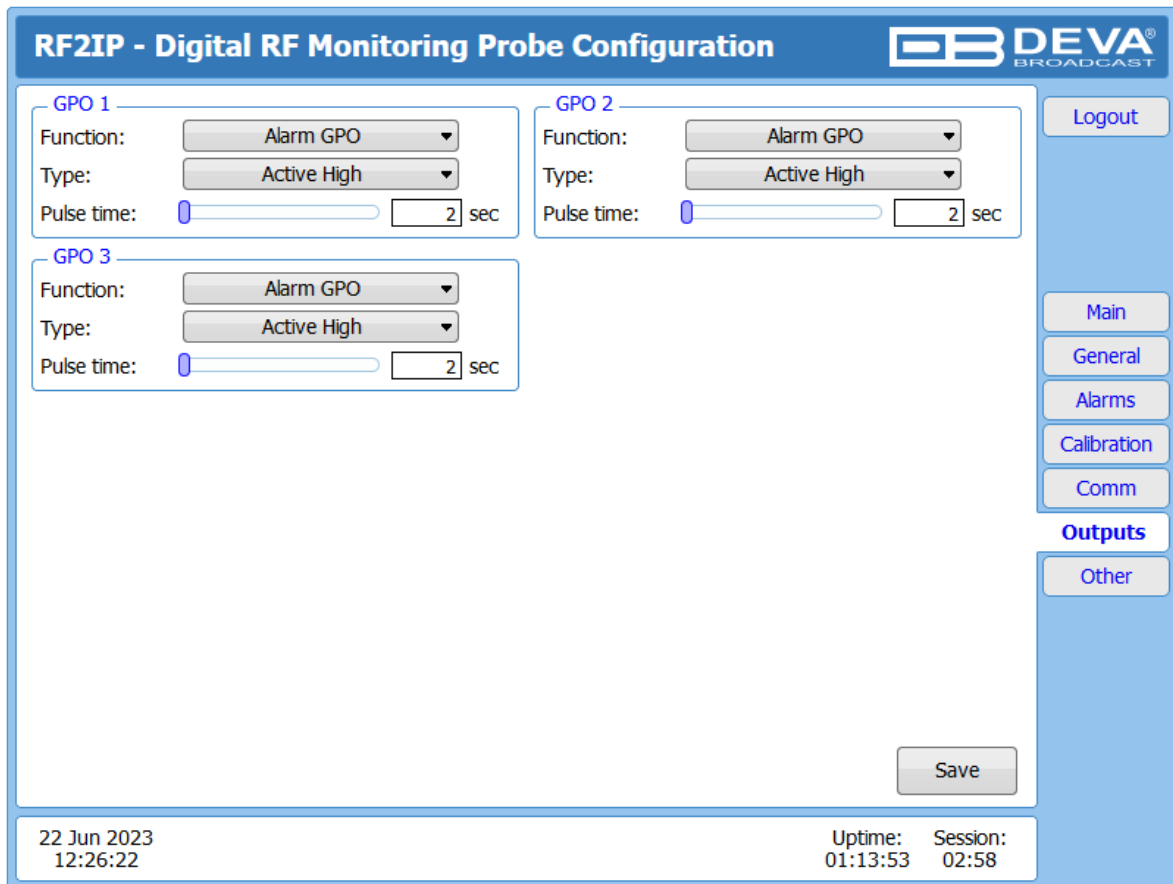

RF2IP - Digital RF Monitoring Probe Configuration

GPO 1
Function: Alarm GPO
Type: Active High
Pulse time: 2 sec

GPO 2
Function: Alarm GPO
Type: Active High
Pulse time: 2 sec

GPO 3
Function: Alarm GPO
Type: Active High
Pulse time: 2 sec

Logout

Main

General

Alarms

Calibration

Comm

Outputs

Other

Save

22 Jun 2023 12:26:22

Uptime: 01:13:53 Session: 02:58

This section of the WEB Interface, allows you to set Function, Type and Pulse time for each GPO.

NOTE: In order for the applied settings to be used press the [Save] button, placed on the bottom right part of the screen.

OTHER

RF2IP - Digital RF Monitoring Probe Configuration

Firmware Update

Firmware file: No file selected.

DSP: 1.5.2146 2023/05/30
LIB: 1.5.2144 2023/05/25

Factory Defaults

Reboot Device

Logout

Main
General
Alarms
Calibration
Comm
Outputs
Other

22 Jun 2023 12:26:51 Uptime: 01:14:23 Session: 02:55

Firmware Update

To update the device firmware, select the new firmware file. After having pressed the Upload button, a dialog window will appear. Confirm the firmware update and wait for the process to complete. Information on current DSP1 and LIB version is also found in this section.

Factory Defaults

[All except IP] – All settings, except for the Network settings (IP Address) will be deleted. To restore RF2IP to its Factory Defaults, press [All except IP]. A new window will appear – confirm that you want to restore the factory defaults and wait for the process to be completed. On completion of the process, the settings should have the proper default values.

Reboot

To start Rebooting of RF2IP, press the [Reboot] button. A dialog warning window will appear. Confirm that you want to reboot the device and wait for the process to be completed.

APPENDIX A

ALARM TRIGGERS

After collecting all the data, the DSP-based core compares the values measured with the predefined by the user threshold levels, for all the parameters monitored. In case that a parameter is beyond limits, the device will initiate the sending of an alarm or warning notification via the selected communication path. All the alarm and warning events are stored in the device's log. It is essential that, if there is a very short fault of the signal, with duration shorter than the 'trigger time', the device would not trigger an alarm or warning.

There are several Alarm Triggers for the following parameters: Forward Power, Reflected Power, Return Loss, VSWR. An option for defining different limits for each of the parameters is present. All these values, the 'trigger time' and the 'release time' have to be assigned separately for each of the alarms.

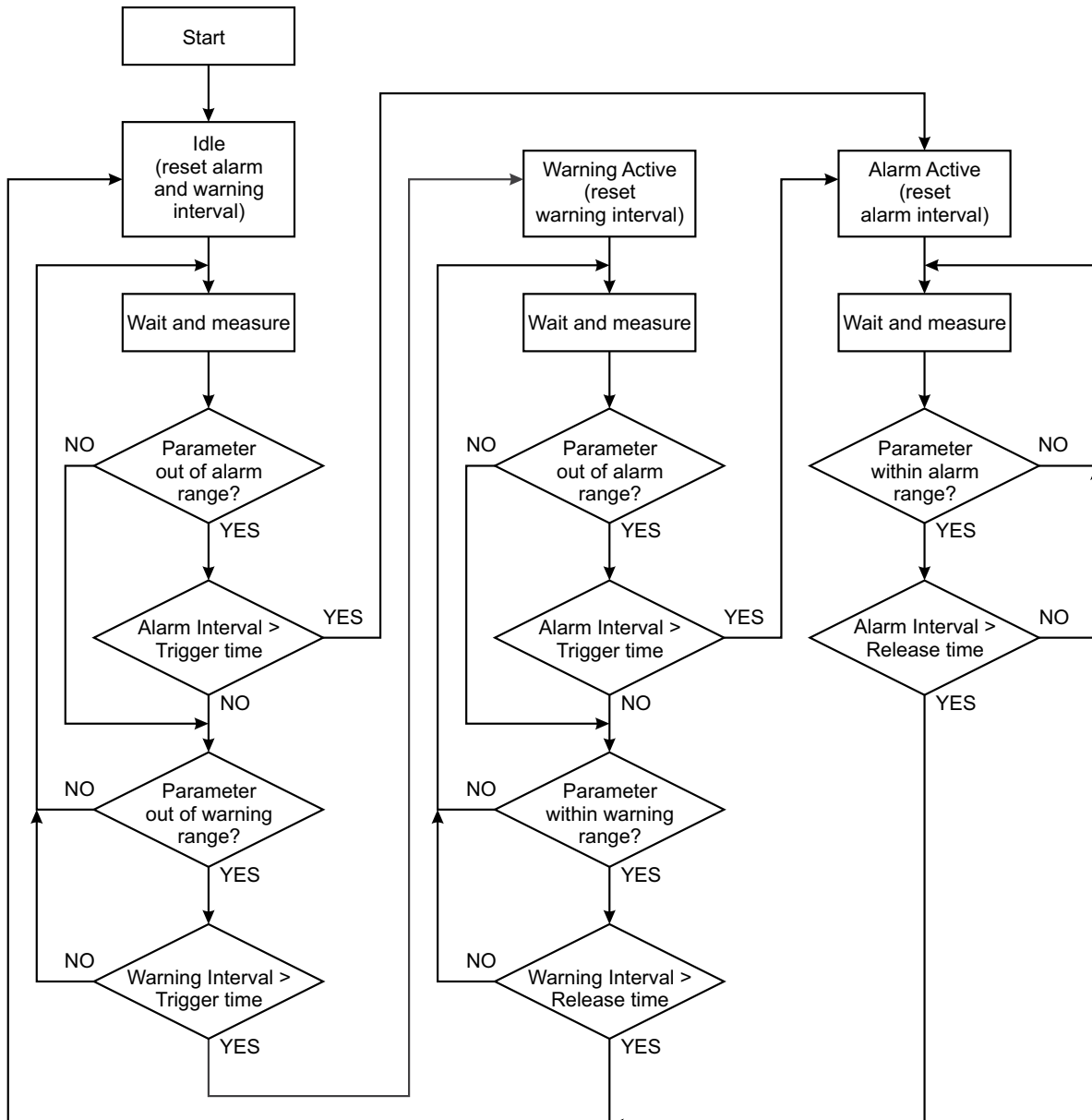

Block Diagram of Alarm Automata

When an observation event takes place, the Alarm Trigger's State will refresh, if necessary. Should we consider an instance when the Alarm Trigger is in Idle state, having in mind that an alarm is not triggered immediately when a parameter level passes beyond threshold: If the parameter level becomes stable, within Thresholds, and the Alarm Trigger Time is not elapsed, then the Alarm Trigger remains in Idle state. If the Alarm Trigger Time expires and the parameter level is still beyond limits, the Alarm Trigger would change its state to High/Low. This would result in predefined actions - Alarm Notifications (E-mail, SNMP trap) and Save a Log Record. The state will not be immediately switched into Idle when the parameter stabilizes, within Threshold levels, not up until the 'Alarm Release Time' is elapsed. Meanwhile, if the parameter crosses again any Threshold, the Alarm Trigger will remain in Active state. If the parameter remain within the Threshold levels and the Alarm Release Time expires, then the Alarm Trigger would switch into Idle state and again predefined actions would be initiated.

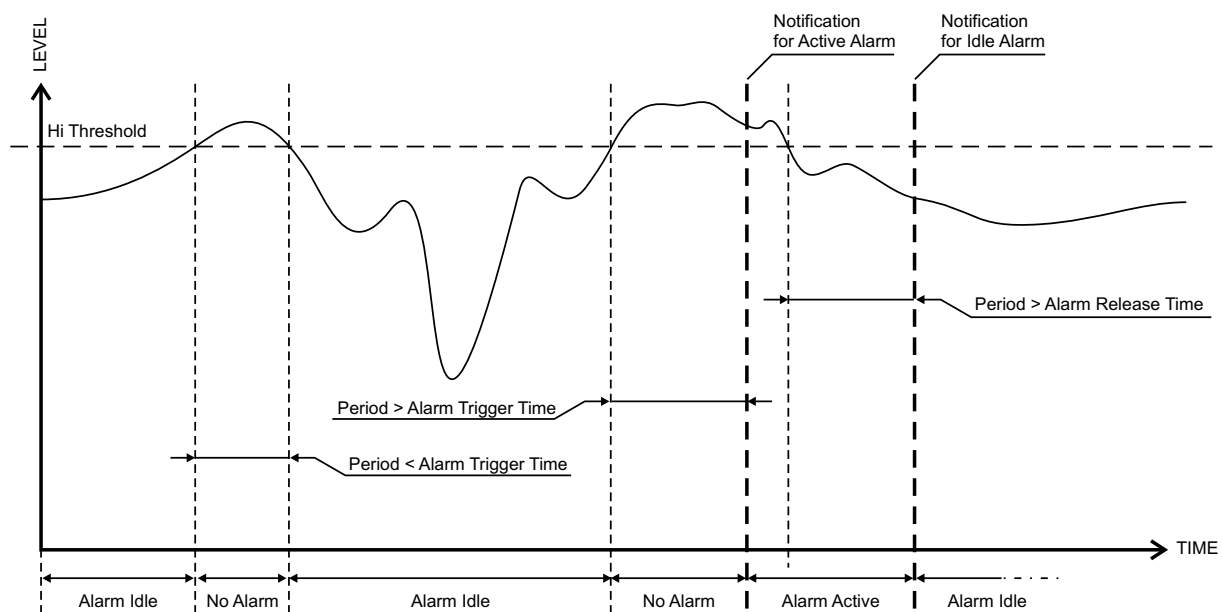

ALARM NOTIFICATIONS

The E-mail, SNMP trap Alarm Notifications contain the following information - device's Alias, date and time of Alarm triggered, channel number, frequency and information about the Alarm activation/deactivation. The basic signal parameters are also included.

Example for E-mal Notification:

Date: 07 Jul 2023, 08:50:22

RF2IP reports ALARM state on 98.00MHz

Alarm: Forward Average < 600.0W

Signal parameters:

Forward Average: 0.0W

Reflected Average: 0.0W

Return Loss: -2.70dB

VSWR: 4.974

WARRANTY TERMS AND CONDITIONS

I. TERMS OF SALE: DEVA Broadcast Ltd. products are sold with an understanding of “full satisfaction”; that is, full credit or refund will be issued for products sold as new if returned to the point of purchase within 30 days following their receipt, provided that they are returned complete and in an “as received” condition.

II. CONDITIONS OF WARRANTY: The following terms apply unless amended in writing by DEVA Broadcast Ltd.

A. The Warranty Registration Card must be completed and returned to DEVA Broadcast Ltd. within 10 days of delivery. Product registration can also be done digitally at <https://www.devabroadcast.com/members/product-registration>, after registering on our website, within 10 days of delivery.

B. This Warranty applies only to products sold “as new.” It is extended only to the original end-user and may not be transferred or assigned without prior written approval by DEVA Broadcast Ltd.

C. This Warranty does not apply to damage caused by improper mains settings and/or power supply.

D. This Warranty does not apply to damage caused by misuse, abuse, accident or neglect. This Warranty is voided by unauthorized attempts at repair or modification, or if the serial identification label has been removed or altered.

III. TERMS OF WARRANTY: DEVA Broadcast Ltd. products are warranted to be free from defects in materials and workmanship.

A. Any discrepancies noted within TWO YEARS of the date of purchase will be repaired free of charge, or the equipment will be replaced with a new or remanufactured product at DEVA Broadcast Ltd. option.

B. Parts and labor for factory repair required after the two-year Warranty period will be billed at prevailing prices and rates.

IV. RETURNING GOODS FOR FACTORY REPAIR:

A. Equipment will not be accepted for Warranty or other repair without a Return Material Authorization (RMA) number issued by DEVA Broadcast Ltd. prior to its return. An RMA number may be obtained by placing an RMA request at <https://www.devabroadcast.com/rma>. The number should be prominently marked on the outside of the shipping carton.

B. Equipment must be shipped prepaid to DEVA Broadcast Ltd. Damage sustained as a result of improper packing for return to the factory is not covered under terms of the Warranty and may occasion additional charges.

V. UPDATES TO THE TERMS OF SERVICE:

For the most up-to-date, valid, and accurate terms, conditions, and product documentation, please visit the official DEVA Broadcast Ltd. website downloads section at <https://www.devabroadcast.com/downloads/deva-documents>. Printed documents may not reflect recent amendments. Reviewing the current online versions ensures you have the latest information.



PRODUCT REGISTRATION CARD

- All fields are required, or warranty registration is invalid and void

Your Company Name _____

Contact _____

Address Line 1 _____

Address Line 2 _____

City _____

State/Province _____ ZIP/Postal Code _____

Country _____

E-mail _____ Phone _____ Fax _____

Which DEVA Broadcast Ltd. product did you purchase? _____

Product Serial # _____

Purchase date ____ / ____ / ____

Installation date ____ / ____ / ____

Your signature*

*Signing this warranty registration form you are stating that all the information provided to DEVA Broadcast Ltd. are truth and correct. DEVA Broadcast Ltd. declines any responsibility for the provided information that could result in an immediate loss of warranty for the above specified product(s).

Privacy statement: DEVA Broadcast Ltd. will not share the personal information you provide on this card with any other parties.