

MAINTENANCE AND OPERATION  
INSTRUCTION MANUAL

# DB36

DAB/DAB+ Radio Streaming Receiver



# Contents

<b>Introduction</b> .....	<b>4</b>
<b>Typographic conventions</b> .....	<b>5</b>
<b>General Information</b> .....	<b>6</b>
<b>Product Features</b> .....	<b>7</b>
<i>Technical Specifications</i> .....	8
<i>Block Diagram</i> .....	9
<b>Factory Default Settings</b> .....	<b>10</b>
<i>How to reset the DB36 to its factory defaults without having access to the WEB interface?</i>	10
<b>Unpacking and inspection</b> .....	<b>11</b>
<b>Mounting</b> .....	<b>11</b>
<i>Rack Requirements 1U</i> .....	11
<i>Rack Requirements Compact Units</i> .....	11
<i>Stand-Alone Devices</i> .....	11
<b>Safety Warning</b> .....	<b>12</b>
<b>Operating Recommendations</b> .....	<b>13</b>
<b>Getting Started</b> .....	<b>14</b>
<i>Connection</i> .....	14
<i>Network Settings</i> .....	15
<i>Network Discovery</i> .....	15
<i>Network Security Recommendations</i> .....	16
<b>Panel Indicators and Appointments</b> .....	<b>17</b>
<i>Front Panel</i> .....	17
<i>Rear Panel</i> .....	18
<b>WEB interface</b> .....	<b>19</b>
<i>Main page</i> .....	19
<i>DAB/DAB+ Dashboard</i> .....	20
<i>Main</i> .....	21
<i>DAB/DAB+</i> .....	22
<i>Ensemble</i> .....	22
<i>Services</i> .....	22
<i>Slideshow</i> .....	22
<i>Band Scan</i> .....	23
<i>Services</i> .....	24
<i>Alarms</i> .....	25
<i>Status</i> .....	27
<i>Log</i> .....	28
<i>General Settings</i> .....	29
<i>Audio</i> .....	30
<i>Tuner</i> .....	31
<i>Communication</i> .....	32
<i>Other</i> .....	34
<b>APPENDIX A</b> .....	<b>35</b>
<i>Alarm Triggers</i> .....	35
<i>Alarm Notifications</i> .....	37
<b>APPENDIX B</b> .....	<b>38</b>
<i>How should I configure the connection between my DEVA Device and an FTP Client?</i>	38
<b>WARRANTY TERMS AND CONDITIONS</b> .....	<b>40</b>
<b>Product Registration Card</b> .....	<b>41</b>

THIS PAGE  
IS INTENTIONALLY  
LEFT BLANK

## Introduction

DEVA Broadcast Ltd. is an international communications and high-technology manufacturing organization, its corporate headquarters and facility located in Burgas, Bulgaria. The company serves the broadcast and corporate markets worldwide – from consumers and small businesses to the largest global organizations. It is dedicated to the research, design, development and provision of advanced products, systems and services. DEVA launched its own brand back in 1997 and has nowadays evolved to become known as a market leader and internationally reputed manufacturer of user-friendly, cost-effective and innovative broadcast products.

Creativity and innovation are deeply woven into DEVA corporate culture. Through successful engineering, marketing and management our team of dedicated professionals creates future-oriented solutions to improve customers' performance. You may rely that all issues communicated to our crew would be addressed accordingly. We pride ourselves on our pre and post-sales support and purchase services, which along with the outstanding quality of our radio gear have won us due respect and the market authority position.

DEVA best-of-breed solutions have become the best sellers for our partners. The strategic partnerships which have been formed with industry leaders during all these years that we have been operating on the broadcasting market, have proved us a reliable business partner and a valuable asset, as our dealers worldwide would confirm. In constant pursuit of precision and long-term satisfaction, DEVA enhances the reputation of our partners and clients alike. Furthermore, we have already a proven merit as a credible partner provider.

Our portfolio offers complete line of high quality and competitive products for FM and Digital Radio, Radio Networks, Telecommunication Operators and regulation authorities. For almost two decades of intensive software and hardware development, we have achieved a unique price-performance and endurance of our product lines. Our company's multitude of equipment and services is in line with the latest technologies and key trends. The most recognizable characteristics attributed to DEVA products are their clear-cut, streamlined design, easiness of use and cost-effectiveness: simplicity of forms but multiplicity of functions.

For us there is no stage when we deem that we have reached the most satisfactory level in our work. Our engineers are in constant pursuit of new ideas and technologies to be captured in DEVA solutions. Simultaneously, a strict control is being exercised at each step of any new development. Experience and hard work are our fundament but the continuous improving process is what we never leave aside. DEVA participates on a regular basis in all landmark broadcasting events, not only to promote its products, but to exchange valuable know-how and experience. We are also engaged in international large-scale projects involving radio and audio solutions which makes us even more competitive on the global market.

All DEVA products are developed and produced in accordance with the latest ISO 9001 quality control standards.

## Typographic conventions

The following table describes important conventions used in the manual.

Convention and Style	Description	Examples
<i>Menu &gt; Sub Menu &gt; Menu Command</i>	A menu item(s) and menu command that you need to click in sequence	Click <i>Settings &gt; General</i>
[Button]	Interface Interactive buttons	Press [OK] to save the changes
<b>NOTE</b>	Important notes and recommendations	<b>NOTE:</b> The notification will appear only once
<u>“Reference Name” on Page XXX</u>	References and links	refer to <u>“New Connection”</u> (see <u>“Monitoring” on page 56</u> )
Example	Used when example text is cited	Example for E-mail Notification: Date: 04 Nov 2013, 07:31:11

## General Information

Created with efficiency and dependability in mind, the DB36 - DAB/DAB+ Radio Streaming Receiver is an indispensable part of DEVA's range of streaming tools and offers another level of reliability and cost-effectiveness. While also retaining the defining characteristics of the DEVA brand, this revolutionary product is specifically dedicated to one of the major areas in the industry - Digital Audio Broadcasting, and fully meets the ETSI EN 300 401 DAB standard.

The DB36 brings a reliable, high-quality streaming functionality as its main asset, while also offering monitoring capabilities. Along with the guaranteed top performance, a crucial advantage of this product is its design – compact, smart and extremely practical. Combining practicality with efficiency, the DB36 boasts a wealth of capabilities and superb features. It has a highly-selective DSP-based tuner and supports the latest DAB & DAB+ standards. Crucially, this product provides an analog input, which allows you to perform not only remote, but also local audio monitoring.

One of the main features of the DB36 is the fact that this tool guarantees no interruption of the broadcast signal. This is achieved through the provided local alarm options and online notifications via rear-panel alarm GPOs, E-mail and SNMP in case there is audio loss or change in the DAB signal and the Left and Right Audio Levels. This allows for a fast response on the part of the maintenance staff so that prolonged signal loss can be prevented.

What is more, this tool offers support for Program Associated Data (PAD), as well as all standard bitrates and VBR, and automatically displays live metadata. While the signal is being monitored and logged, the DB36 also measures the DAB signal quality, as well as the Left & Right Audio level values and stores them, thereby allowing for future analysis. A standard FTP client is all that is required for the collected data to be easily downloaded.

Users can also easily control and set up their DB36 unit remotely through their PC, tablet or smart phone via a standard web browser; iOS and Android devices are also supported.

Compact and affordable, with a remarkable set of features, DEVA's DB36 is a definite must-have when reliable streaming of the DAB/DAB+ signal is needed.

## Product Features

- DAB/DAB+ compliant receiver
- Real Time Audio Program Streaming
- Support for Program Associated Data (PAD)
- Predefined DAB channels scan or manual tune
- Detailed DAB component information
- High-end digital tuner
- Real Time Audio Program Streaming
- Built-in easy to use WEB and FTP server
- Apple and Android devices support
- Protected access to the device settings
- Headphone output with front panel level control
- SNTP for automatic synchronization of the built-in clock
- LAN port for full TCP/IP remote control and monitoring
- Adjustable MIN/MAX alarms for RF, Left & Right Audio Levels
- Alarm dispatch via E-mail, SNMP ver.2C and GPO
- Firmware updates will ensure improved operation

## TECHNICAL SPECIFICATIONS

<b>DAB/DAB+ RADIO</b>	
RF frequency range	168 - 240 MHz
DAB/DAB+	Band III Channels 5A - 13F
Sensitivity	18 dB $\mu$ V
Input connector	BNC 50 $\Omega$
In compliance with	ETSI EN 300 401
Ensemble acquisition Time	940 ms
L&R Audio	1%, +5.0 to -50.0 dB, 0.1 dB resolution
<b>DAB/DAB+ METERING</b>	
Quality indicators	RSSI, SNR, CNR, FIC Quality, FIB Errors, FFT Offset
PAD	DLS, MOT
Metadata Displayed	Ensemble Label, Component List & ID, Service List & ID, Dynamic Label, PTY, Sample Rate, Bit Rate, Gain, Mode, Service Mode, Protection Info, Current CU & Address, Country, Language, Time & Date
<b>OUTPUTS</b>	
Audio stream	Icecast/Shoutcast compatible audio stream
Alarms	E-mail, SMS, SNMP
Headphone	1/8" (3.5mm) Phone Jack
GSM Modem	15-pin Male D-Sub Connector
<b>NETWORK</b>	
Connector	RJ-45
Type	Ethernet
Device discovery	UPnP support
<b>MEASUREMENTS AND LOG STORAGE</b>	
Storage	16GB Build-in Memory Card
Data format	Text, CSV
<b>OPERATING CONDITIONS</b>	
Temperature	-15°C to 55°C
Humidity	< 95%, non-condensing
Altitude	0 to 5000m above sea level
<b>POWER</b>	
Voltage	External, 12V/1A
Power Consumption	12VA
Connector	Power Jack 5.5mm
<b>SIZE AND WEIGHT</b>	
Dimensions (W;H;D)	125 x 31 x 160 mm
Shipping Weight	270 x 54 x 230 mm / 1.054 kg

## BLOCK DIAGRAM

A simplified block diagram of DB36 is shown below

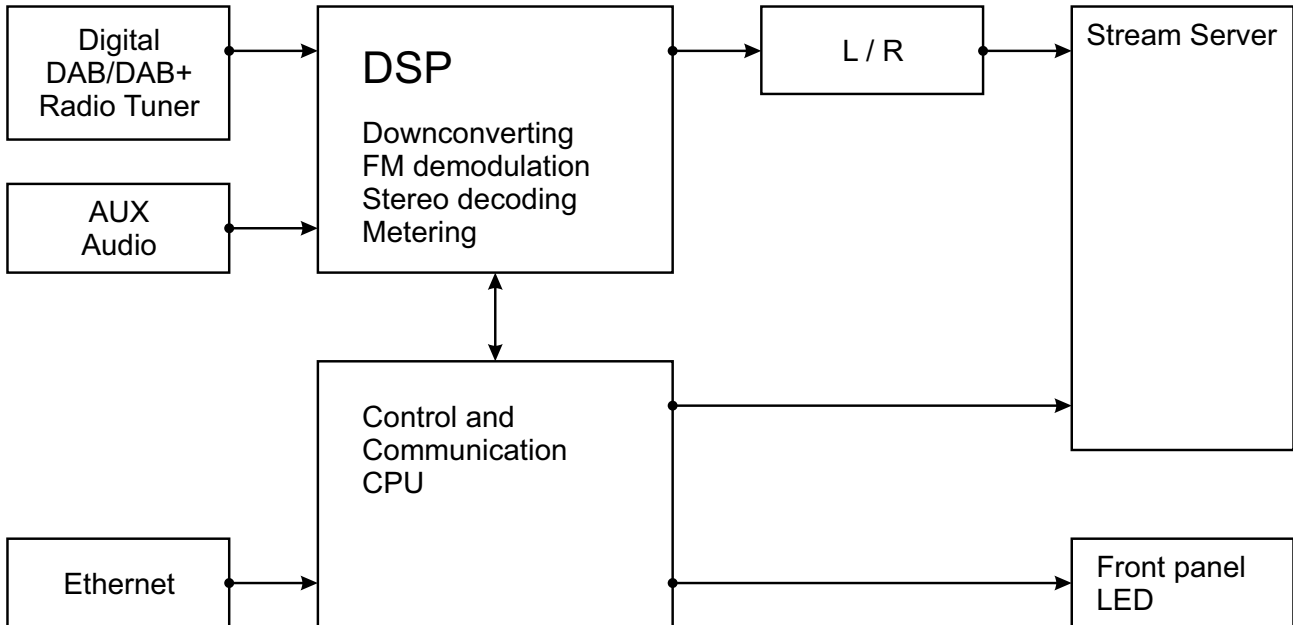

Because of the all-digital, minimalist-discrete-component nature of device circuitry, we have not provided schematic diagrams of the DB36 in this Manual. Please, note that:

**NO USER-SERVICEABLE COMPONENTS INSIDE.  
REFER ALL SERVICING TO  
QUALIFIED TECHNICAL PERSONNEL.**

## Factory Default Settings

### HOW TO RESET THE DB36 TO ITS FACTORY DEFAULTS WITHOUT HAVING ACCESS TO THE WEB INTERFACE?

---

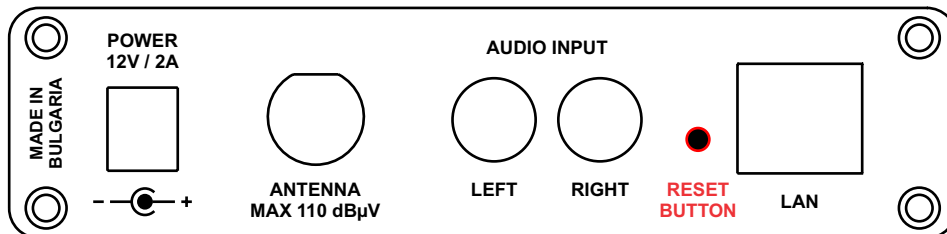

1. Disconnect the power supply cable from the unit.
2. Find the RESET button on Rear panel (labeled in red on the picture), press and hold it.
3. While pressing the RESET button, connect the power supply cable to the unit and wait until the POWER led starts blinking.
4. Release the RESET button and wait for the DB36 to reboot.
5. Once the reboot is complete, the DB36 will be returned to its factory default settings.

## Unpacking and inspection

Upon receipt, the equipment should be inspected for possible shipping damages. If such are found or suspected, notify the carrier at once and contact DEVA Broadcast Ltd. The original shipping carton box and packing materials should be kept for possible reuse, in case of return for Warranty repair, for example. Shipping damages as a result of improper packing for return may invalidate the Warranty!

**The packing material (plastic bags, polystyrene, nails, etc.) must never be left within reach of children, as these items are potential sources of danger.**

**IT IS VERY IMPORTANT** that the [“Product Registration Card”](#) included in the Manual be completed accurately and returned. This will assure coverage of the terms of the Warranty and it will provide a means of trace in case of lost or stolen equipment. In addition, the user will automatically receive SERVICE OR MODIFICATION INSTRUCTIONS from DEVA Broadcast Ltd.

## Mounting

### **RACK REQUIREMENTS 1U**

---

The unit mounts in a standard 19-inch equipment rack and requires only 1 $\frac{3}{4}$  inches (1U) of vertical rack space. In order the painted finish around the mounting holes to be protected, the use of plastic washers is recommended.

### **RACK REQUIREMENTS COMPACT UNITS**

---

Our customized 1U 19-inch rack accessory provides a professional mounting option for up to three compact size DEVA units. It is made of milled aluminum and finished in black powder coat. Two extra blanking panels and set of mounting screws are provided with each rack bracket kit.

### **STAND-ALONE DEVICES**

---

DEVA's stand-alone units (Radio Explorer series, BandScanner series, DVB Explorer) do not require additional tools or installation brackets.

## Safety Warning

### **ALWAYS OBSERVE THE SAFETY PRECAUTIONS.**

Careful observance of the safety precautions will help prevent physical injury, damage of the equipment, and extend the equipment life.

- The servicing of electronic equipment should be performed only by qualified personnel;
- Before removing the covers the unit must be switched off and the mains cable unplugged;
- When the equipment is open, the power supply capacitors should be discharged using a suitable resistor;
- Never touch the wires or the electrical circuits;
- Use insulated tools only;
- Never touch the metal semiconductor. They might carry high voltages;
- For removing and installing electronic components, follow the recommendations for handling MOS components.
- Do not remove the factory sticker from the equipment. It contains information as regards the name, serial number and MAC address of the device.
- To join the equipment to the mains supply, use the power cord purchased with the equipment.

## Operating Recommendations

To ensure normal operation of the DEVA unit, we recommend following the instructions listed below.

- Install the unit in places with good air conditioning. The unit is designed to operate within the ambient temperature range of 10 to 50°C. The equipment rack should be ventilated in order for the device to keep its internal temperature below the maximum ambient temperatures;
- We do not recommend installation in rooms with high humidity, dusty places or other aggressive conditions;
- Although the device is intended to be installed closed to exciters or transmitters, we do recommend the device to be located away from abnormally high RF fields.
- Use only checked power supply cables. We strongly recommend the usage of shielded cables;
- Connect the DEVA unit to reliable power supply sources only. In case of unstable power supply, please use Uninterruptible Power Supply (UPS);
- Use the device only with its top cover on to avoid electromagnetic anomalies. Otherwise, this may cause problems with the normal functionality of the unit;
- To ensure normal remote operation of the unit, make sure to connect the device to a good quality Internet connection;
- For the normal operation of your DEVA device, check if the network settings past through all the required data traffic.

## Getting Started

In order for the normal operation of the DB36 to be guaranteed, you will need fulfill the following conditions:

1. Standard Ethernet 10/100M connection;
2. Correctly assigned Network configuration and device settings.

To make sure that all the conditions are fulfilled please, follow the instructions below.

### CONNECTION

---

1. Install the unit on its operation place;
2. Using the provided power cable, connect the unit to the power supply network;
3. Connect the antenna cable to the RF antenna input connector located on the rear panel of the device;
4. Connect the DB36 to the TCP/IP network using direct network cable;
5. **IF GSM OPTION IS SUPPORTED** - Using the connection cable provided, connect the optional GSM modem. In order for better GSM network coverage to be achieved, please select proper place for the GSM antenna.

**NOTE:** The GSM antenna must be installed far enough from the monitoring devices. The GSM modem radiates RF signal that may cause spurious emissions that will may interfere with the accuracy of the measurements.

## NETWORK SETTINGS

---

After connecting the network cable the Led ‘LAN’ located on the rear panel must be ON or flashing. The next and most important step for configuration is the adjustment procedure of the Network Communication. The settings shown below are Default Network Settings:

DHCP	Enabled
IP	Assigned by DHCP
Mask	Assigned by DHCP
Gateway	Assigned by DHCP
DNS	Assigned by DHCP
HTTP Port	80

## NETWORK DISCOVERY

---

This is a network setting that defines whether your computer can see (find) other computers and devices on the network and whether other computers on the network can see your computer. By default, Windows Firewall blocks network discovery but you can enable it.

1. Open Advanced sharing settings by clicking the Start button, and then on “Control Panel”. In the search box, type “network”, click “Network and Sharing Center”, and then, in the left pane click “Change advanced sharing settings”;
2. Select your current network profile;
3. Click “Turn on network discovery”, and then click save changes.

**NOTE:** If you’re prompted for an administrator password or confirmation, type the password, provide confirmation or contact your system administrator.

If you have already enabled this function on your computer DB36 will be automatically added to the Device list section. The device will be ready for usage and no additional adjustments will be required except user name and password.

**NOTE:** If the port is different than the default one (80), it is necessary to specify it, for example:  
`http://192.168.1.2:9000`

**ATTENTION:** Depending on Internet Protocol Settings, the assigned IP address may not be visible outside your local network, thus the device may be accessed only within that network. Consult with your network administrator for the appropriate IP settings.

## **NETWORK SECURITY RECOMMENDATIONS**

---

1. It is not recommended the DB36 to be directly connected to the Internet. This may lead to unregulated access and/or problematic operation of the device. To ensure secure connection, we recommend the device to be installed behind a router with an active firewall.
2. If remote access to the device is needed, we recommend using VPN to the router or the port of the relevant service (WEB, SNMP, Application, etc.) to be properly NAT forwarded.
3. If NAT forward is used, it is highly recommended random ports of your choice to be used. Not the standard ones (80 for WEB, 161 for SNMP, etc.).
4. Using DMZ connection is not recommended.
5. Make sure to change the standard access credentials (usernames and passwords, SNMP communities).

For detailed information as regards the recommendations listed above or need of further instructions, please contact your network administrator.

## Panel Indicators and Appointments

### FRONT PANEL

---

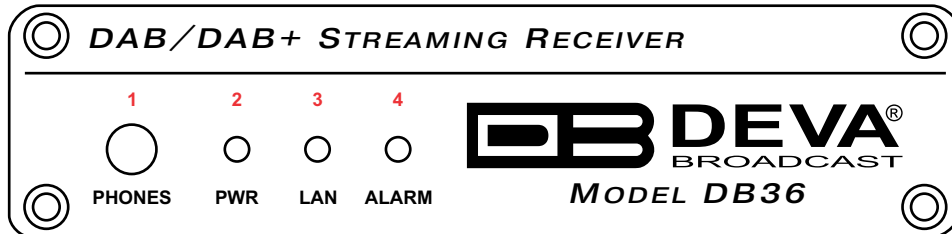

- 1 - Phones Output - Audio signal from the tuned frequency.
- 2 - Power LED Indicator
- 3 - LAN LED Indicator. This LED can be in one of the following states:
  - Off - No User Connected, Logger is active;
  - Blinking – User is connected, Logger is inactive;
- 4 - ALARM LED Indicator. This LED can in one of the following states:
  - Off - no active alarm
  - On - at least on alarm is active

## REAR PANEL

---

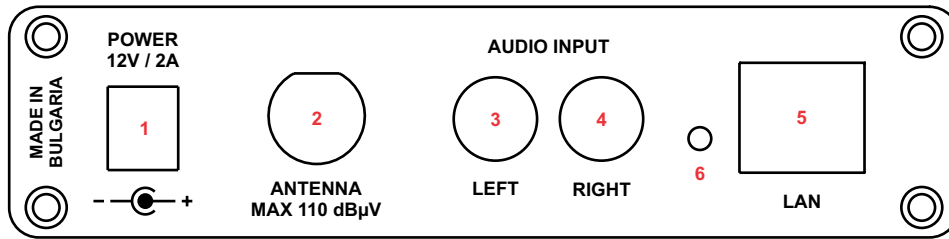

- 1 - Power Supply (12V, 2A);
- 2 - Antenna Input - BNC connector for FM Antenna;
- 3 - AUX Audio Input LEFT channel - standard RCA female jack;
- 4 - AUX Audio Input RIGHT channel - standard RCA female jack;
- 5 - LAN Port / Internet Input – standard RJ-45 port;
- 6 - Factory Defaults reset button

## WEB interface

The DB36 provides you with a protected access to the device settings. The device serves only one user at a time, thus username and password will be requested when login. Default values are admin and pass.

### MAIN PAGE

The WEB Interface is visually divided into two sections Left and Right.

- On the Right are all the specific contextual readings of the currently selected menu page.
- On the Left is the so called “dashboard” of the device - General Tuner and Channel readings, functional buttons. This section of the WEB interface is constant part of each screen, hence allowing immediate tuner interactions.

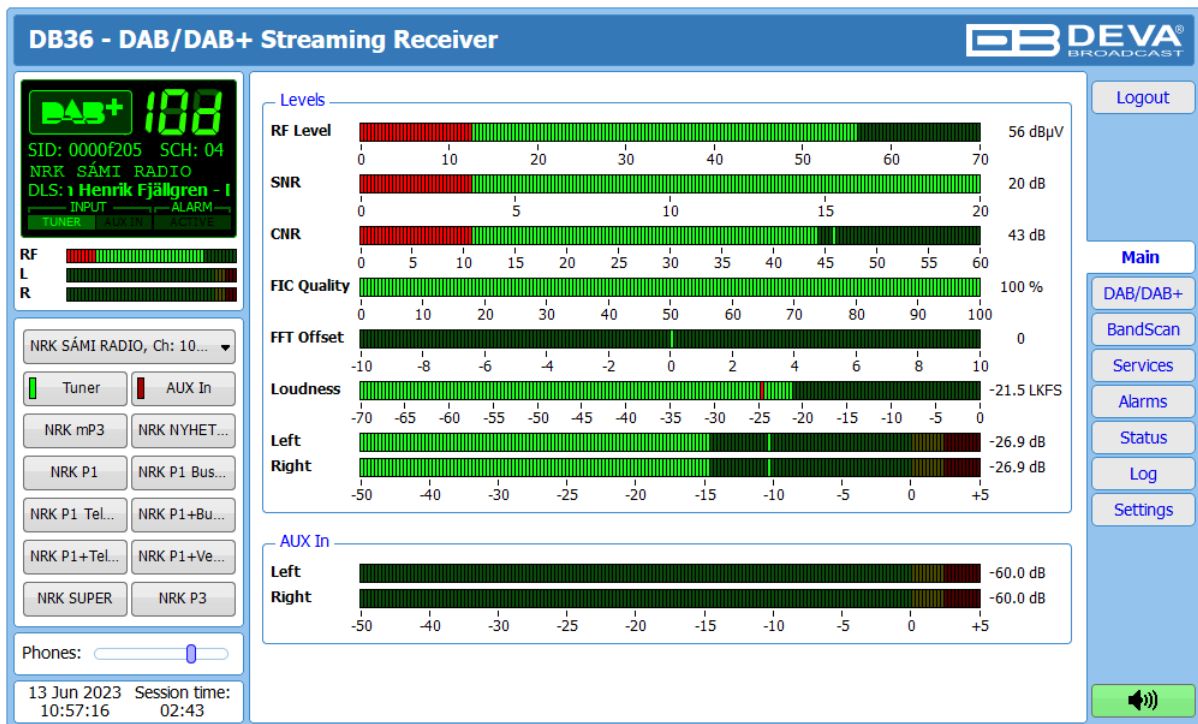

## DAB/DAB+ DASHBOARD

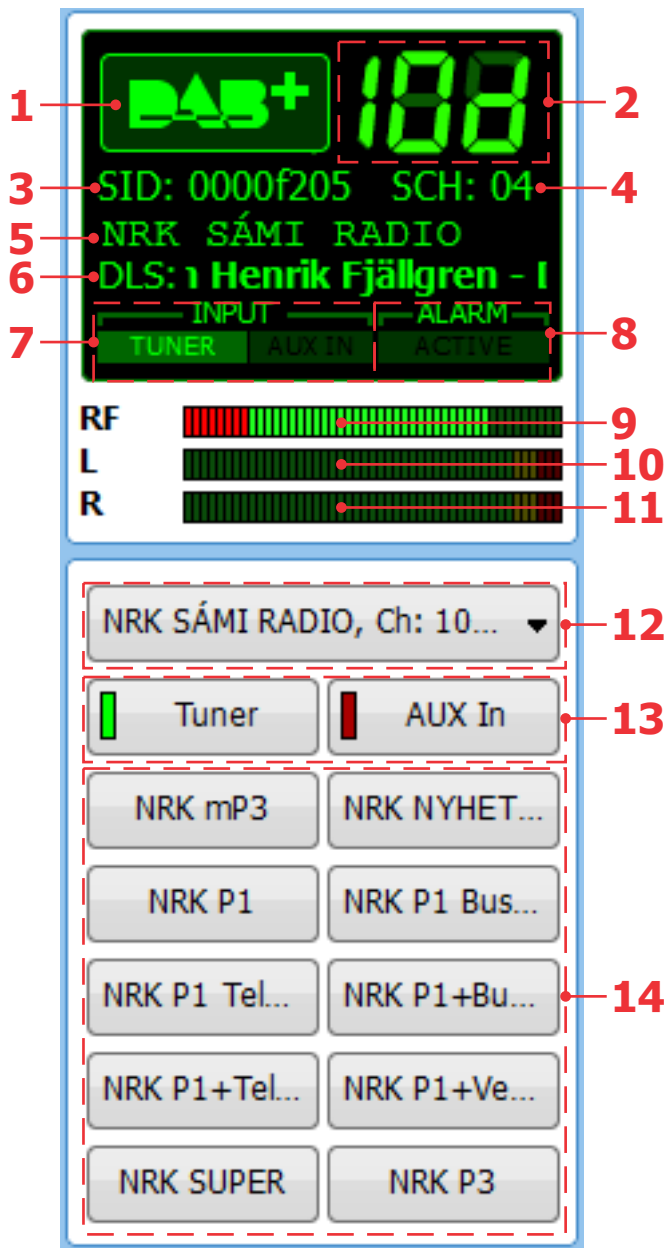

1. DAB/DAB+ signal lock indicator;
2. Frequency indicator showing currently tuned frequency;
3. SID – This 16-bit field shall specify the DAB Service Identifier (SID) to which the information block data applies;
4. SCH – Sub Channel ID;
5. Currently selected service label;
6. DLS – (Dynamic Label Segment) scrolling text;
7. INPUT – input currently in use;
8. ALARM – the alarm presence indicator will be lit if an alarm is detected;
9. RF Level indicator. The red zone (low level) indicates low RF level;
10. Left Audio indicator;
11. Right Audio indicator;
12. Drop-down Select Service menu – A list containing all services available in the current Ensemble.

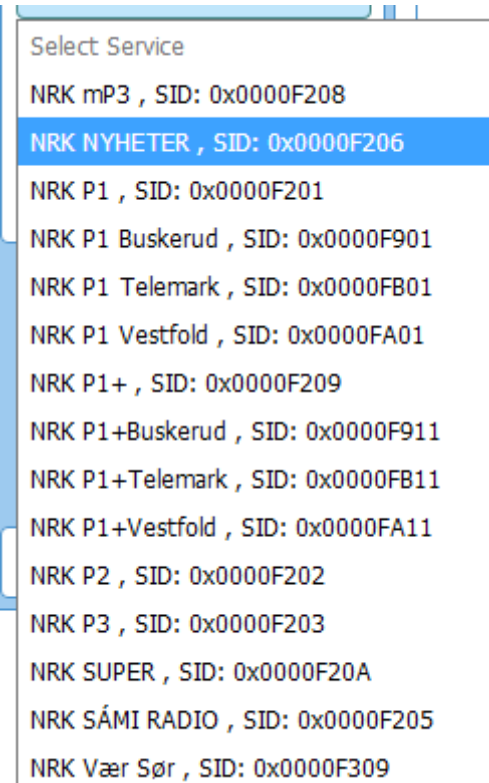

13. INPUT selector;
14. Service Preset Buttons – when one of the buttons is pressed, the Tuner will be set to the predefined service.

## MAIN

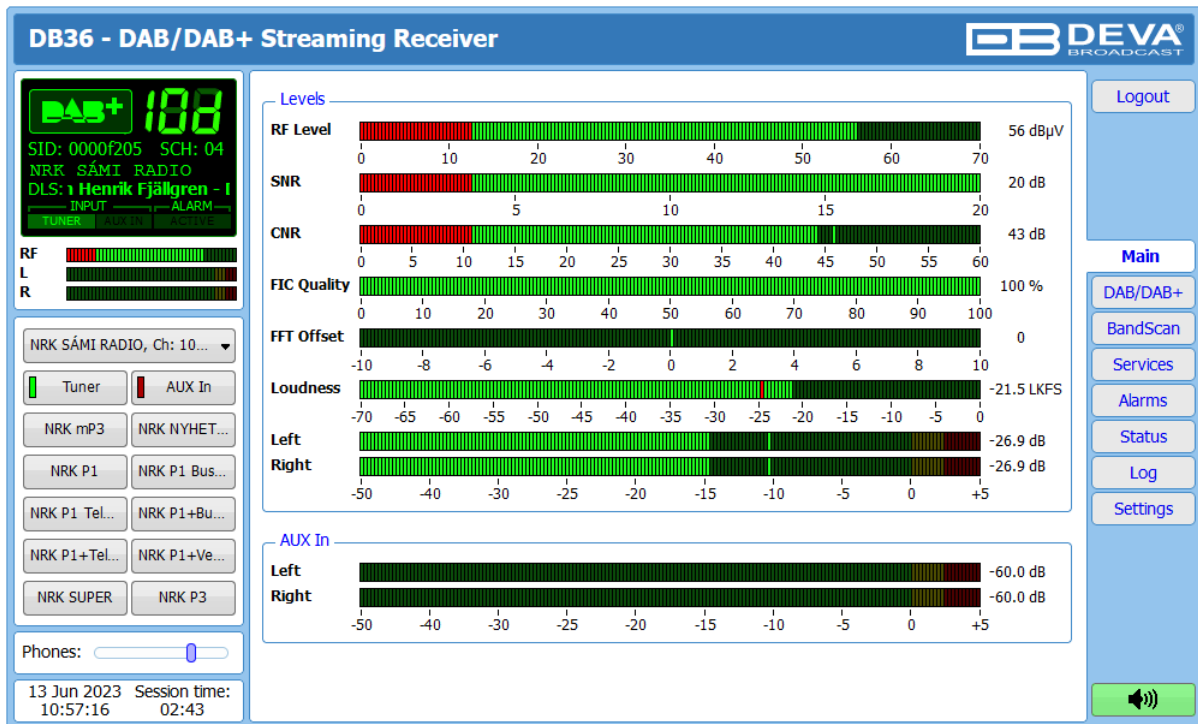

The main screen contains information on the mandatory parameters for the currently selected DAB/DAB+ station, represented as LED readings.

You can easily select the preferred audio frequency by using the selection buttons, placed on the left part of the screen. All station presets are user defined.

[Listen] button – used to Play/Stop the current audio stream (audio device will be required).

AUX In – if in use, the LED meters will indicate the Left and Right audio levels

Phones slider – allows the user to adjust the volume.

## DAB/DAB+

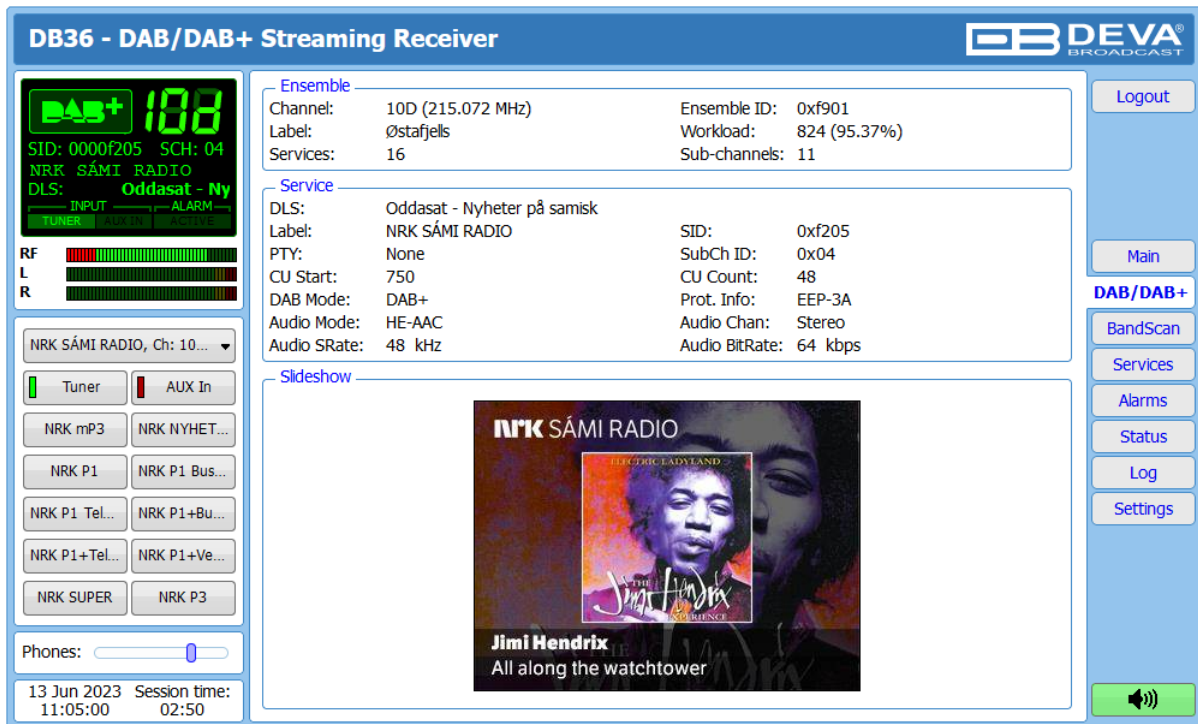

**DB36 - DAB/DAB+ Streaming Receiver**

**Ensemble**  
 Channel: 10D (215.072 MHz) Ensemble ID: 0xf901  
 Label: Østafjells Workload: 824 (95.37%)  
 Services: 16 Sub-channels: 11

**Service**  
 DLS: Oddasat - Nyheter på samisk  
 Label: NRK SÁMI RADIO SID: 0xf205  
 PTY: None SubCh ID: 0x04  
 CU Start: 750 CU Count: 48  
 DAB Mode: DAB+ Prot. Info: EEP-3A  
 Audio Mode: HE-AAC Audio Chan: Stereo  
 Audio SRate: 48 kHz Audio BitRate: 64 kbps

**Slideshow**  
 NRK SÁMI RADIO  
 Jimi Hendrix  
 All along the watchtower

13 Jun 2023 Session time:  
 11:05:00 02:50

### Ensemble

This section provides information about the currently selected ensemble - Channel, Label, Ensemble ID, Workload, number of available Services and Sub-channels. NR (signal-to-noise) and CNR (carrier-to-noise) indicators in dB, represented as LED readings, are also available.

### Services

An Ensemble will typically carry multiple services from multiple radio networks. List of the available Services can be found in this tab.

### Slideshow

If available, Slideshow will also be displayed.

## BAND SCAN

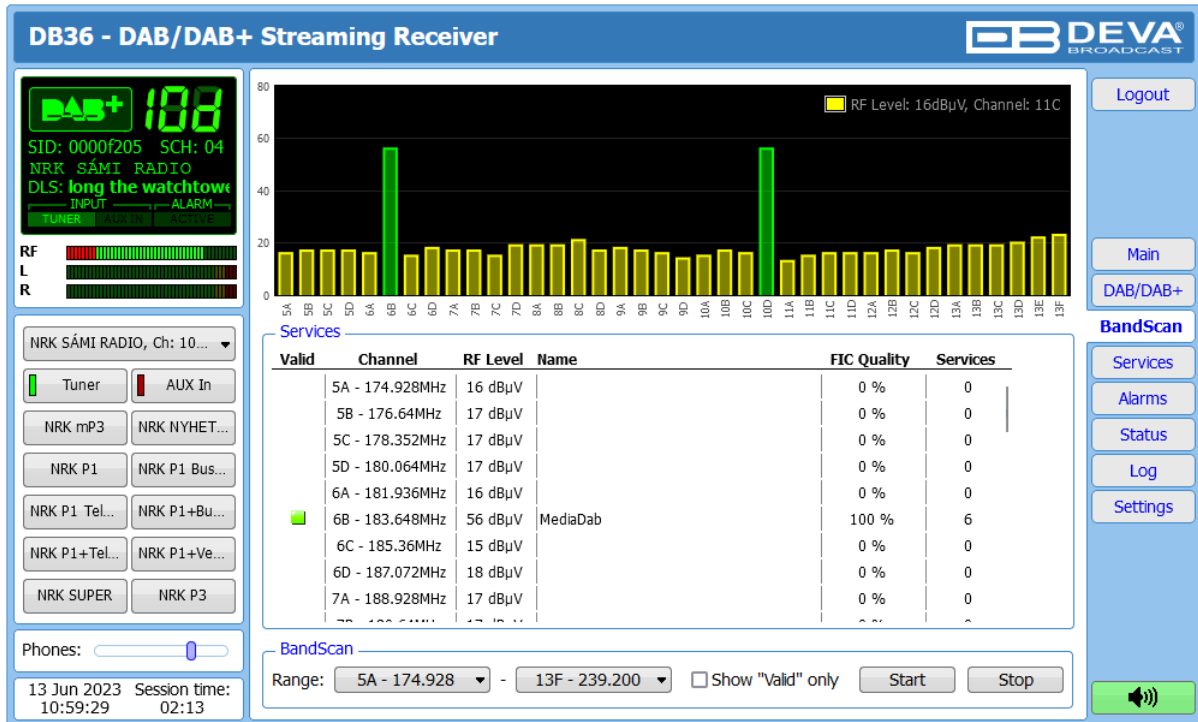

**DB36 - DAB/DAB+ Streaming Receiver**

SID: 0000f205 SCH: 04  
 NRK SÁMI RADIO  
 DLS: long the watchtow

RF Level: 16dBuV, Channel: 11C

Valid	Channel	RF Level	Name	FIC Quality	Services
	5A - 174.928MHz	16 dBuV		0 %	0
	5B - 176.64MHz	17 dBuV		0 %	0
	5C - 178.352MHz	17 dBuV		0 %	0
	5D - 180.064MHz	17 dBuV		0 %	0
	6A - 181.936MHz	16 dBuV		0 %	0
■	6B - 183.648MHz	56 dBuV	MediaDab	100 %	6
	6C - 185.36MHz	15 dBuV		0 %	0
	6D - 187.072MHz	18 dBuV		0 %	0
	7A - 188.928MHz	17 dBuV		0 %	0

BandScan Range: 5A - 174.928 - 13F - 239.200  Show "Valid" only [Start] [Stop]

The bandscanning mode is easily customized by setting range of the scan. To start a bandscan follow the instructions listed below:

1. Set the bandscan range;
2. Specified whether all results or the Valid only will be shown;
3. Press the [Start] button;
4. The scan can be stopped at any point by pressing the [Stop] button.

All valid results will be illuminated in green. When Valid only is selected, the services list will look like this:

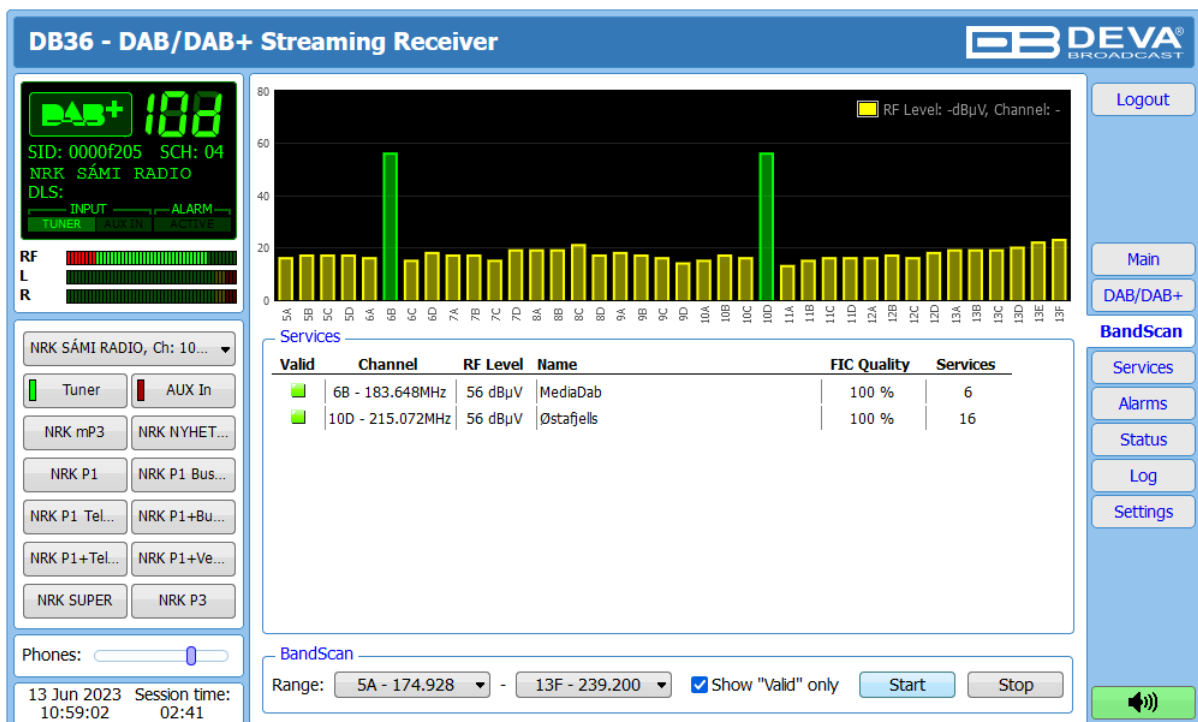

**DB36 - DAB/DAB+ Streaming Receiver**

SID: 0000f205 SCH: 04  
 NRK SÁMI RADIO  
 DLS:

RF Level: -dBuV, Channel: -

Valid	Channel	RF Level	Name	FIC Quality	Services
■	6B - 183.648MHz	56 dBuV	MediaDab	100 %	6
■	10D - 215.072MHz	56 dBuV	Østafjells	100 %	16

BandScan Range: 5A - 174.928 - 13F - 239.200  Show "Valid" only [Start] [Stop]

## SERVICES

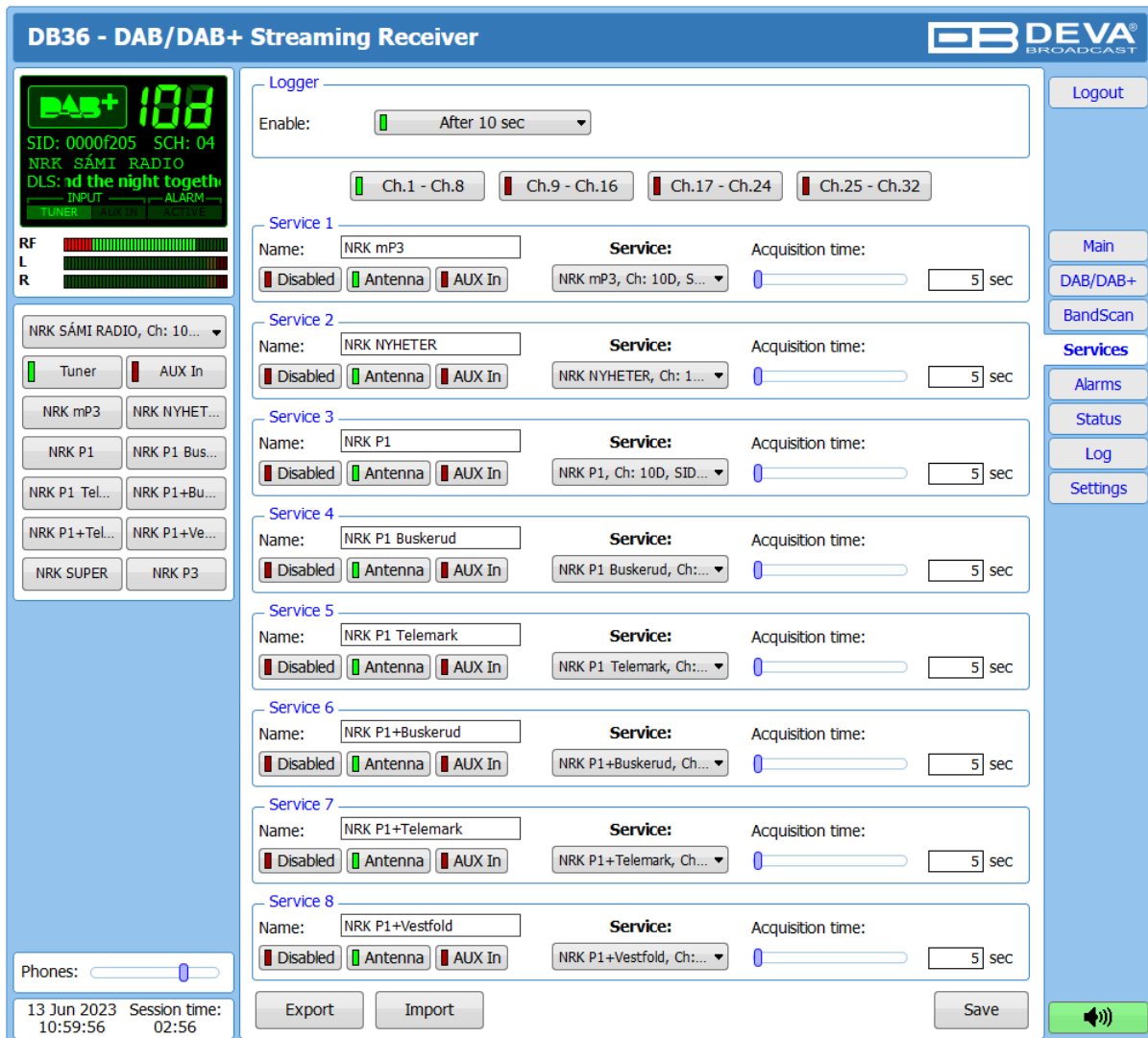

This section of the WEB Interface allows up to 32 services to be chosen and monitored, by applying the needed settings.

When the desired adjustments are being made, the DB36 will monitor all of the selected services at regular intervals. All of the collected information is accessible through the built-in FTP Server. (see [“Download files via FTP” on page 38](#))

Follow the steps below to initiate the simplified process of starting a Logger mode:

1. Set the Logger’s start time delay;
2. Use the [Ch.1 – Ch. 8] to [Ch. 25 – Ch. 32] buttons to toggle trough the services;
3. Select the Service number to be monitored and apply the needed settings – Name, Service and Acquisition time. **IMPORTANT:** Acquisition time for each service should be set individually.
4. In order for a channel to be included in the campaign, the [Antenna]/[AUX In] button should be selected. To exclude a service from the campaign select the [Disabled] button.

## ALARMS

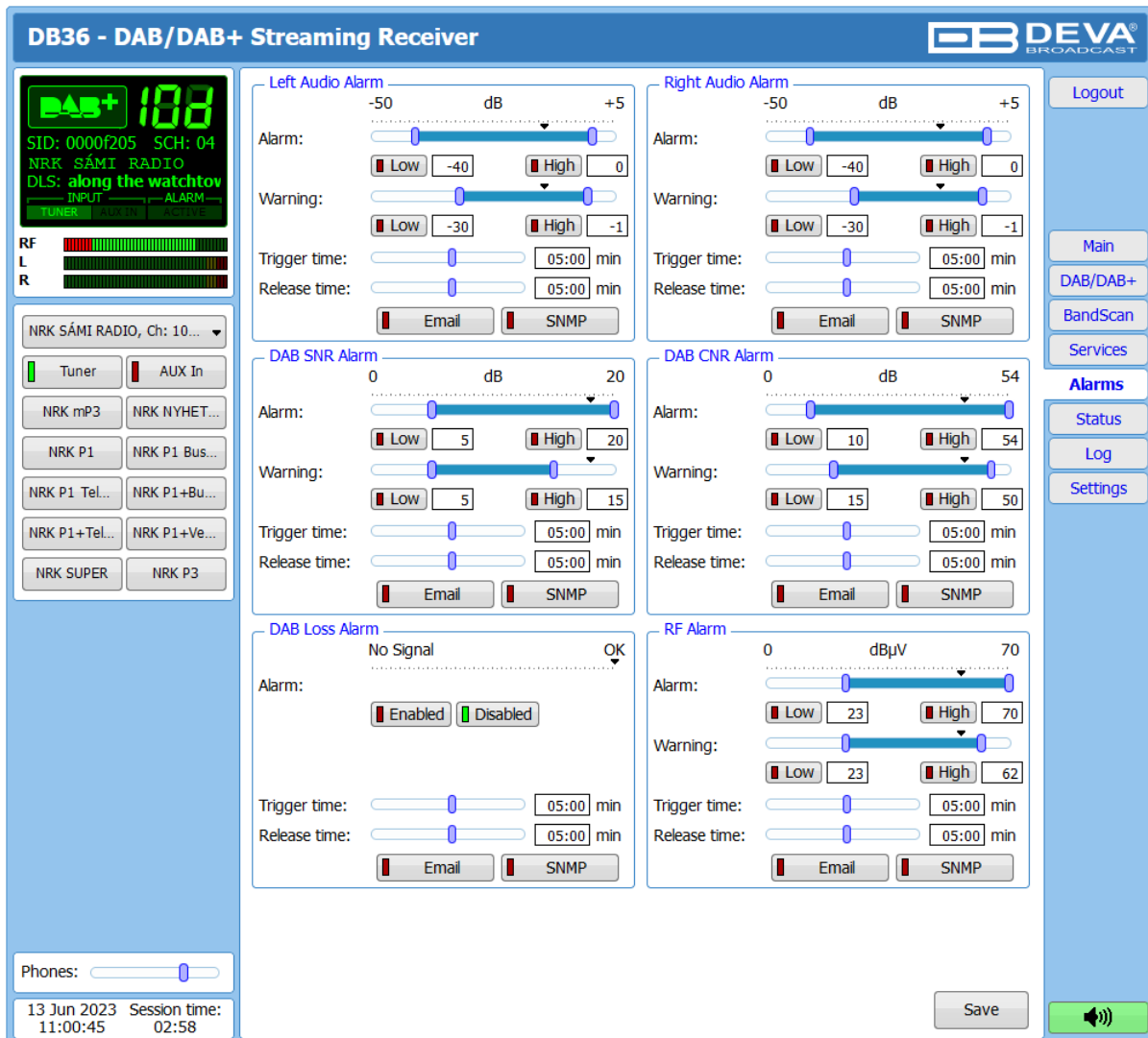

The DB36 can send alarm notification via E-mail or SNMP. Measurement windows can be set for each of the six parameters: RF, Left and Right audio levels, DAB Loss, DAB SNR, DAB CNR. Trigger and alarm release times can be set for each alarm.

Please bear in mind that the type of alarm notification is set for each parameter individually. To enable the preferred notification method, press the relevant button so that it could be illuminated in green.

### RF Alarm, DAB SNR, DAB CNR, DAB Left & Right Audio Alarms

The settings applied to these alarms - are identical and are explained in details below.

**Range** – interactive slider used to adjust the **Low & High thresholds** at which an alarm will be generated. Depending on the user's preferences, the same setting can be applied via the Thresholds placed below the slider, but in figures.

**Warning** – interactive slider used to adjust the **Low & High warning values** at which a warning will be generated. Depending on the user's preferences, the same setting can be applied via the Thresholds placed below the slider, but in figures.

**Trigger Time** – waiting time before active alarm is generated;

**Release Time** – waiting time before idle alarm is generated;

Once the **Range, Thresholds, Trigger** and **Release times** are set, the preferred alarm type should be selected.

#### **DAB Loss Alarm**

**Enable** – In order for the alarm to be generated, the function should be enabled;

**Trigger Time** – waiting time before active alarm is generated;

**Release Time** – waiting time before idle alarm is generated.

# STATUS

**DB36 - DAB/DAB+ Streaming Receiver**

**Device**  
Serial: 36DL10000  
MAC: 30:89:44:00:0A:6F  
FW: 1.8.2094 2023/01/05

**Network**  
Type: Assigned by DHCP  
IP: 192.168.1.36  
Netmask: 255.255.255.0  
Gateway: 192.168.1.1  
DNS 1: 192.168.1.1  
DNS 2: 8.8.8.8

**Alarms**  
Left: - Right: -  
CNR: - SNR: -  
DAB: - RF: -

RF: [Bar chart]  
L: [Bar chart]  
R: [Bar chart]

NRK SÁMI RADIO, Ch: 10...  
Tuner [Bar chart] AUX In [Bar chart]  
NRK mP3 NRK NYHET...  
NRK P1 NRK P1 Bus...  
NRK P1 Tel... NRK P1+Bu...  
NRK P1+Tel... NRK P1+Ve...  
NRK SUPER NRK P3

Phones: [Slider]  
13 Jun 2023 Session time:  
11:01:26 02:56

Logout  
Main  
DAB/DAB+  
BandScan  
Services  
Alarms  
Status  
Log  
Settings

The status tab shows the basic Device, Alarm and Network statuses (IP address, MAC, etc.).

# LOG

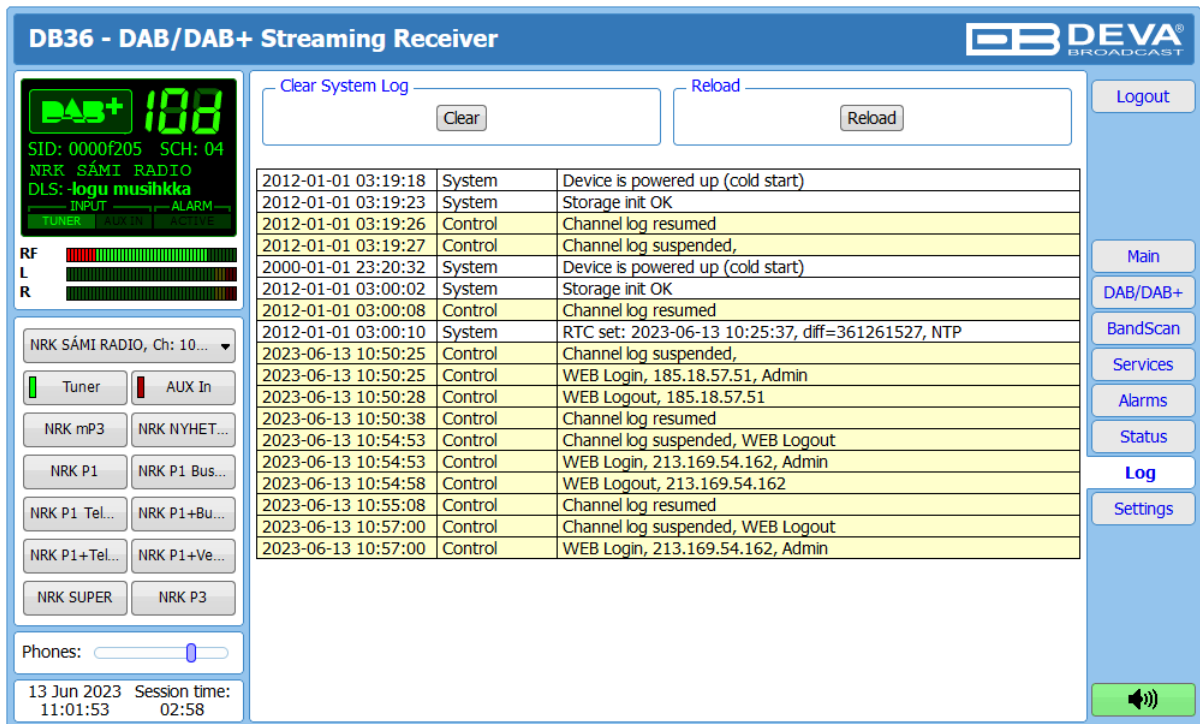

**DB36 - DAB/DAB+ Streaming Receiver**

Clear System Log  Reload

2012-01-01 03:19:18	System	Device is powered up (cold start)
2012-01-01 03:19:23	System	Storage init OK
2012-01-01 03:19:26	Control	Channel log resumed
2012-01-01 03:19:27	Control	Channel log suspended,
2000-01-01 23:20:32	System	Device is powered up (cold start)
2012-01-01 03:00:02	System	Storage init OK
2012-01-01 03:00:08	Control	Channel log resumed
2012-01-01 03:00:10	System	RTC set: 2023-06-13 10:25:37, diff=361261527, NTP
2023-06-13 10:50:25	Control	Channel log suspended,
2023-06-13 10:50:25	Control	WEB Login, 185.18.57.51, Admin
2023-06-13 10:50:28	Control	WEB Logout, 185.18.57.51
2023-06-13 10:50:38	Control	Channel log resumed
2023-06-13 10:54:53	Control	Channel log suspended, WEB Logout
2023-06-13 10:54:53	Control	WEB Login, 213.169.54.162, Admin
2023-06-13 10:54:58	Control	WEB Logout, 213.169.54.162
2023-06-13 10:55:08	Control	Channel log resumed
2023-06-13 10:57:00	Control	Channel log suspended, WEB Logout
2023-06-13 10:57:00	Control	WEB Login, 213.169.54.162, Admin

13 Jun 2023 Session time: 11:01:53 02:58

Here are listed all the Device System Events. The local measurements and logs are saved in the internal device memory. All log files can be downloaded via the built-in FTP server. For information on how the connection between the DB36 and an FTP Client should be configured, please refer to [“Download files via FTP” on page 38](#).

[Clear] will delete the System log.

[Reload] will refresh the information.

## GENERAL SETTINGS

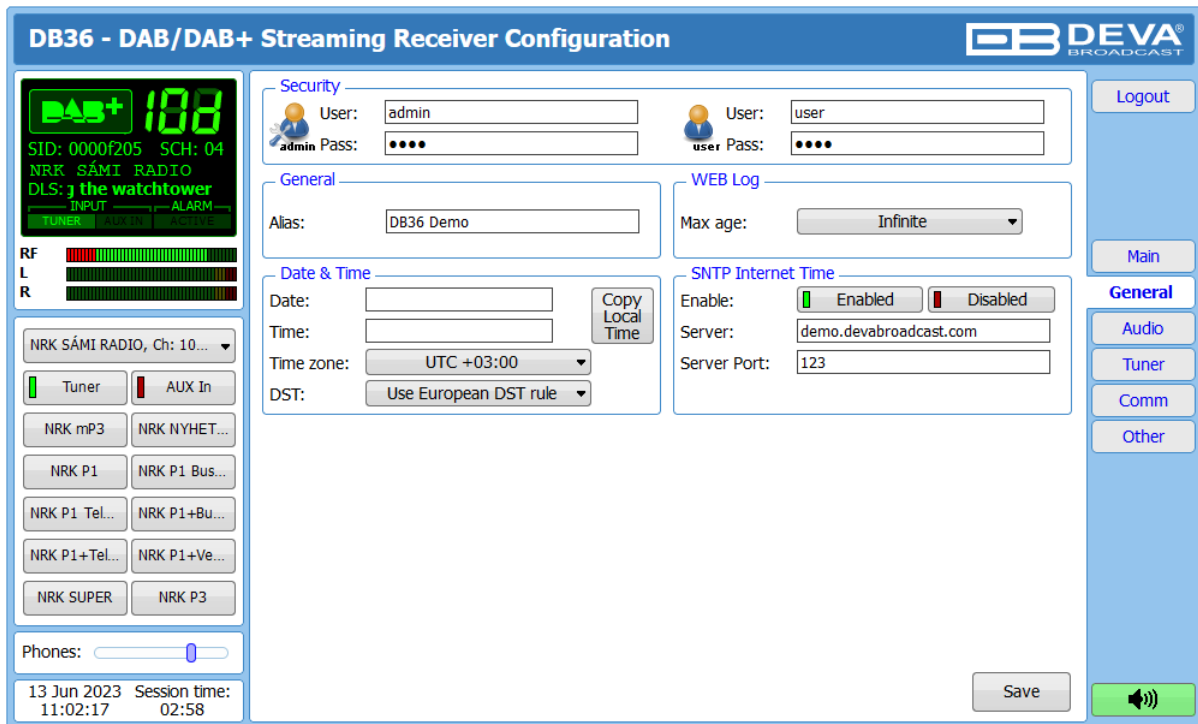

DB36 provides you with protected access to the device settings. You can choose between two types of log in.

- As an Administrator – It will give you full control over the settings of the device;
- As a User – that will allow you to just monitor the device and to choose different stations, while the Settings bar remains locked.

In order for the security of DB36 to be enhanced, a new **username** and **password** could be set from the Security section. By choice, you can change the name of the device (General section). Later on, it will be used as a title name for all WEB pages. Customizing the name will make the device more recognizable.

**WEB Log** – the maximum storage time of the System Log file is chosen from here. If the file is older than the specified maximum will be deleted.

**Date & Time** – used for manually set the current Date and Time. [Copy Local Time] button will set the Date and Time to correspond to that of your computer.

**SNTP Internet Time** – Synchronizes automatically the DB36 clock to a millisecond with the Internet time server. Enable this function in order to use it. (Specifying the server closest to your location will improve the accuracy).

**NOTE:** In order for the applied settings to be used press the [Save] button, placed on the bottom right part of the screen.

## AUDIO

The screenshot displays the 'DB36 - DAB/DAB+ Streaming Receiver Configuration' web interface. The top header includes the DEVA BROADCAST logo and the title. The interface is divided into several sections:

- Left Panel:** A digital display showing '102.3' and 'NRK SÁMI RADIO' with 'DLS: on Henrik Fjällgren'. Below it are RF signal strength bars for L and R channels, a channel selector set to 'NRK SÁMI RADIO, Ch: 10...', and a grid of buttons for various radio programs like 'NRK mP3', 'NRK NYHET...', 'NRK P1', 'NRK P1 Bus...', 'NRK P1 Tel...', 'NRK P1+Bu...', 'NRK P1+Tel...', 'NRK P1+Ve...', 'NRK SUPER', and 'NRK P3'. A 'Phones' slider is also present.
- Audio Stream Server:** A section with 'Enable' (checked), 'Server Port' (3600), and 'Quality' (320 kbps).
- Tuner Audio:** A section with 'Audio Gain' set to 0.0 dB.
- AUX Audio In:** A section with 'Audio Gain' set to 0.0 dB.
- Right Panel:** A vertical navigation menu with buttons for 'Logout', 'Main', 'General', 'Audio' (highlighted), 'Tuner', 'Comm', and 'Other'. A 'Save' button is located at the bottom right of the main configuration area.
- Bottom Left:** A status bar showing the date '13 Jun 2023' and 'Session time: 11:02:49'.

The Audio section of the WEB Interface allows the user to apply the needed settings to the Audio Stream Server, Tuner Audio and AUX Audio In of the DB36.

**Audio Stream** – In order for the option to be used, the user needs to [Enable] it and specify **Server Port** and **Quality**.

**IMPORTANT:** Press the [Save] button to save the applied changes.

# TUNER

**DB36 - DAB/DAB+ Streaming Receiver Configuration**

102.3

SID: 0000F205 SCH: 04  
 NRK SÁMI RADIO  
 DLS: Sámi musihkka  
 INPUT ALARM  
 TUNER

RF   
 L   
 R

NRK SÁMI RADIO, Ch: 10...

Tuner
 AUX In

NRK mP3

NRK NYHET...

NRK P1

NRK P1 Bus...

NRK P1 Tel...

NRK P1+Bu...

NRK P1+Tel...

NRK P1+Ve...

NRK SUPER

NRK P3

Phones:

13 Jun 2023 Session time:  
 11:03:20 02:54

**DAB Channel**  
 5A:  5A - 174.928MHz  
 5B:  5B - 176.640MHz  
 5C:  5C - 178.352MHz  
 5D:  5D - 180.064MHz

**DAB Channel**  
 6A:  6A - 181.936MHz  
 6B:  6B - 183.648MHz  
 6C:  6C - 185.360MHz  
 6D:  6D - 187.072MHz

**DAB Channel**  
 7A:  7A - 188.928MHz  
 7B:  7B - 190.640MHz  
 7C:  7C - 192.352MHz  
 7D:  7D - 194.064MHz

**DAB Channel**  
 8A:  8A - 195.936MHz  
 8B:  8B - 197.648MHz  
 8C:  8C - 199.360MHz  
 8D:  8D - 201.072MHz

**DAB Channel**  
 9A:  9A - 202.928MHz  
 9B:  9B - 204.640MHz  
 9C:  9C - 206.352MHz  
 9D:  9D - 208.064MHz

**DAB Channel**  
 10A:  10A - 209.936MHz  
 10B:  10B - 211.648MHz  
 10C:  10C - 213.360MHz  
 10D:  10D - 215.072MHz

**DAB Channel**  
 11A:  11A - 216.928MHz  
 11B:  11B - 218.640MHz  
 11C:  11C - 220.352MHz  
 11D:  11D - 222.064MHz

**DAB Channel**  
 12A:  12A - 223.936MHz  
 12B:  12B - 225.648MHz  
 12C:  12C - 227.360MHz  
 12D:  12D - 229.072MHz

**DAB Channel**  
 13A:  13A - 230.784MHz  
 13B:  13B - 232.496MHz  
 13C:  13C - 234.208MHz  
 13D:  13D - 235.776MHz  
 13E:  13E - 237.488MHz  
 13F:  13F - 239.200MHz

**Available Services**

Service	Channel	SID	SubCh ID
<input type="radio"/> NRK mP3	10D	0x0000F208	0x02
<input type="radio"/> NRK NYHETER	10D	0x0000F206	0x05
<input type="radio"/> NRK P1	10D	0x0000F201	0x39
<input checked="" type="radio"/> NRK P1 Buskerud	10D	0x0000F901	0x39
<input type="radio"/> NRK P1 Telemark	10D	0x0000FB01	0x39
<input type="radio"/> NRK P1 Vestfold	10D	0x0000FA01	0x39
<input type="radio"/> NRK P1+	10D	0x0000F209	0x34
<input type="radio"/> NRK P1+Buskerud	10D	0x0000F911	0x34
<input type="radio"/> NRK P1+Telemark	10D	0x0000FB11	0x34
<input type="radio"/> NRK P1+Vestfold	10D	0x0000FA11	0x34
<input type="radio"/> NRK P2	10D	0x0000F202	0x32
<input type="radio"/> NRK P3	10D	0x0000F203	0x33
<input type="radio"/> NRK SUPER	10D	0x0000F20A	0x03

The Tuner Section gives control over Tuner settings, allowing you to select a DAB channel and service. All available services will be listed below once the list is collected from the multiplex data.

**IMPORTANT:** Press the [Save] button to save the applied changes.

## COMMUNICATION

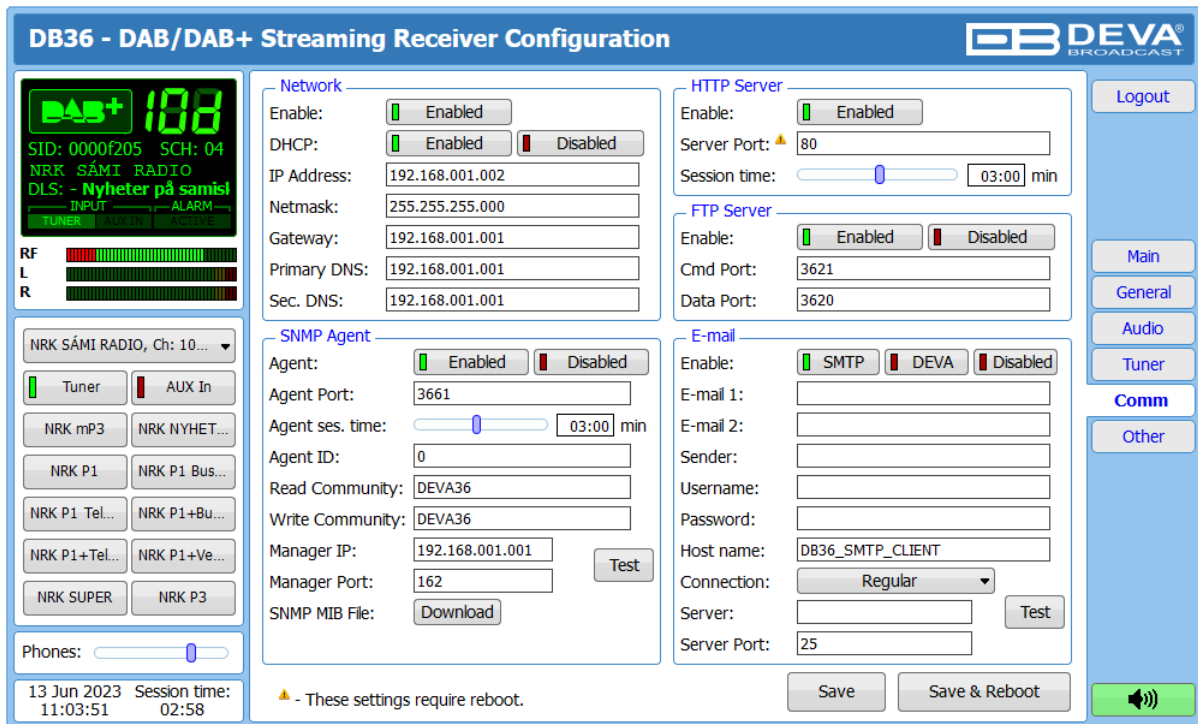

### Network

The network addresses could be set manually (static IP) or automatically via a DHCP server. To set static IP, MASK, GATEWAY and DNS addresses, the DHCP should be disabled. In order for the built-in DHCP client to be activated, the function should be enabled. When the DHCP client is activated, all assigned values will be shown in the relevant fields on the Status Screen. If due to any reason, the DHCP procedure cannot be completed, DB36 will use AutoIP and will generate an IP Address.

### HTTP Server

[Enabled] the HTTP Server. Specify the Server Port and session timeout. If the [Enabled] button is not illuminated in green, the option is disabled.

### FTP Server

[Enabled]/[Disabled] the FTP Server. Specify the Command and Data Ports to be used.

### SNMP Agent

**Agent** – [Enabled]/[Disabled] the SNMP Agent.

Specify Agent ID, Agent Port, Read/Write Communities, Manager IP, Manager Port and session timeout. Agent ID is used for identification of the device among others, when an SNMP notification is being sent.

Once all needed settings are applied, use the [Test] button to generate a test notification, which upon success will be received by the SNMP Manager.

Press the [Download] button to download the latest available DB36 SNMP MIB file.

**NOTE:** The MIB file may vary from one firmware revision to another. Downloading this file from the device, guarantees that you have the proper MIB file.

## E-mail

To use the email notification option, please make sure it is [Enabled] by pressing the relevant button. Then follow the instructions below:

1. Enter the desired alarm recipients in e-mail 1 and/or e-mail 2 fields.
2. Fill in your e-mail account settings: Sender, Username and Password, Server, SNMP port and connection type.
3. It is mandatory the type of connection with the server to be specified from Connection - Regular, Encrypted.
4. The Server port will be changed accordingly. Please note that the most commonly used port will be entered in the field. If the port that is to be used is different, change it manually to the correct value.
5. We recommend you to use the [Test] button and generate a test e-mail, which upon success will be delivered to the specified E-mail 1 and/or E-mail 2. Example of Test E-mail Message:

DB36 Test Message.

Please do not reply to this e-mail.

If you experience difficulties in the set-up, or would like to use DEVA account for sending of alarm email notifications, press the [DEVA] button option, and:

1. Complete the recipient emails (E-mail 1 and E-mail 2) only.
2. The other fields must be left blank, otherwise the email notification option will not be working.
3. We recommend you to use the [Test] button and generate a test e-mail, which upon success will be delivered to the specified E-mail 1 and/or E-mail 2. Example of Test E-mail Message:

DB36 Test Message.

Please do not reply to this e-mail.

Even though using the DEVA account eases the set-up process, we recommend user account to be used for sending of email notifications, and the DEVA account for test purposes. When using DEVA account, please note that the stable 24/7 connection depends on the mail service provider and cannot be guaranteed.

## IMPORTANT NOTES:

1. In order for the applied settings to be used press the [Save] button, placed on the bottom right part of the screen.
2. When changes to the HTTP Server Port are applied, the [Save & Reboot] button needs to be pressed.

## OTHER

### Firmware Update

To update the device firmware, select the new firmware file. After having pressed the Upload button, a dialog window will appear. Confirm the firmware update and wait for the process to complete. Information on current DSP1, DSP2 and WEB version is also found in this section.

### Storage

Information about the device storage space is found in this section. The entire internal storage could be deleted by pressing the [Format] button.

### System Log

By pressing the [Clear] button, all records in the system log will be deleted.

### Factory Defaults

[All except IP] – all settings, except for the Network settings (IP Address) will be deleted.

To restore DB36 to its Factory Defaults, press [All except IP]. A new window will appear – confirm that you want to restore the factory defaults and wait for the process to be completed. On completion of the process, the settings should have the proper default values.

### Reboot

To start Rebooting of DB36, press the [Reboot] button. A dialog warning window will appear. Confirm that you want to reboot the device and wait for the process to be completed.

# APPENDIX A

## ALARM TRIGGERS

After collecting all the data, the DSP-based core compares the values measured with the predefined by the user threshold levels, for all the parameters monitored. In case that a parameter is beyond limits, the device will initiate the sending of an alarm or warning notification via the selected communication path. All the alarm and warning events are stored in the device's log. It is essential that, if there is a very short fault of the signal, with duration shorter than the 'trigger time', the device would not trigger an alarm or warning.

There are several Alarm Triggers for the following parameters: RF, Left and Right audio levels, DAB Loss, DAB SNR, DAB CNR. An option for defining different limits for each of the parameters is present. All these values, the 'trigger time' and the 'release time' have to be assigned separately for each of the alarms.

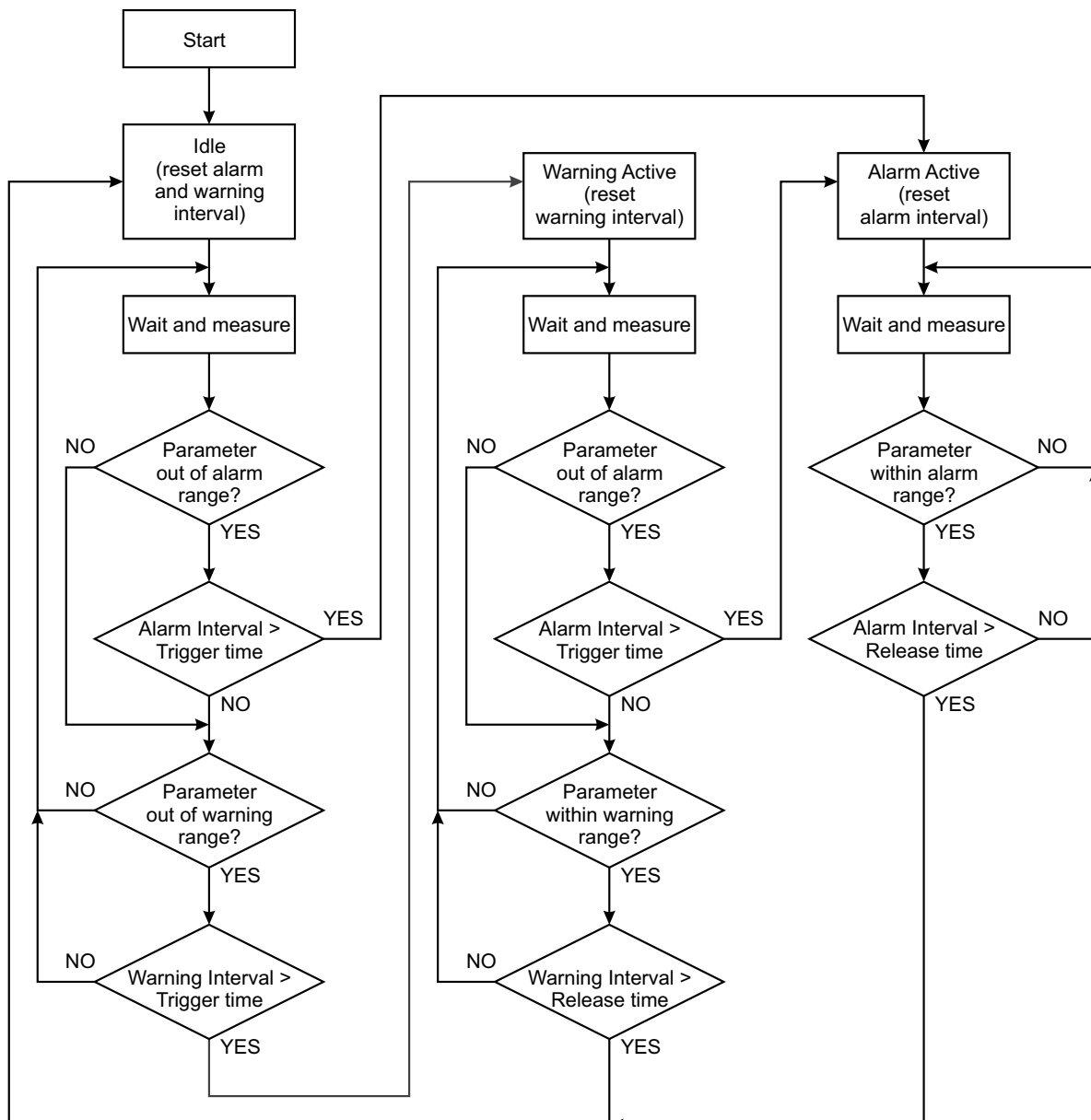

*Block Diagram of Alarm Automata*

When an observation event takes place, the Alarm Trigger's State will refresh, if necessary. Should we consider an instance when the Alarm Trigger is in Idle state, having in mind that an alarm is not triggered immediately when a parameter level passes beyond threshold: If the parameter level becomes stable, within Thresholds, and the Alarm Trigger Time is not elapsed, then the Alarm Trigger remains in Idle state. If the Alarm Trigger Time expires and the parameter level is still beyond limits, the Alarm Trigger would change its state to High/Low. This would result in predefined actions - Alarm Notifications (E-mail, SNMP trap) and Save a Log Record. The state will not be immediately switched into Idle when the parameter stabilizes, within Threshold levels, not up until the 'Alarm Release Time' is elapsed. Meanwhile, if the parameter crosses again any Threshold, the Alarm Trigger will remain in Active state. If the parameter remain within the Threshold levels and the Alarm Release Time expires, then the Alarm Trigger would switch into Idle state and again predefined actions would be initiated.

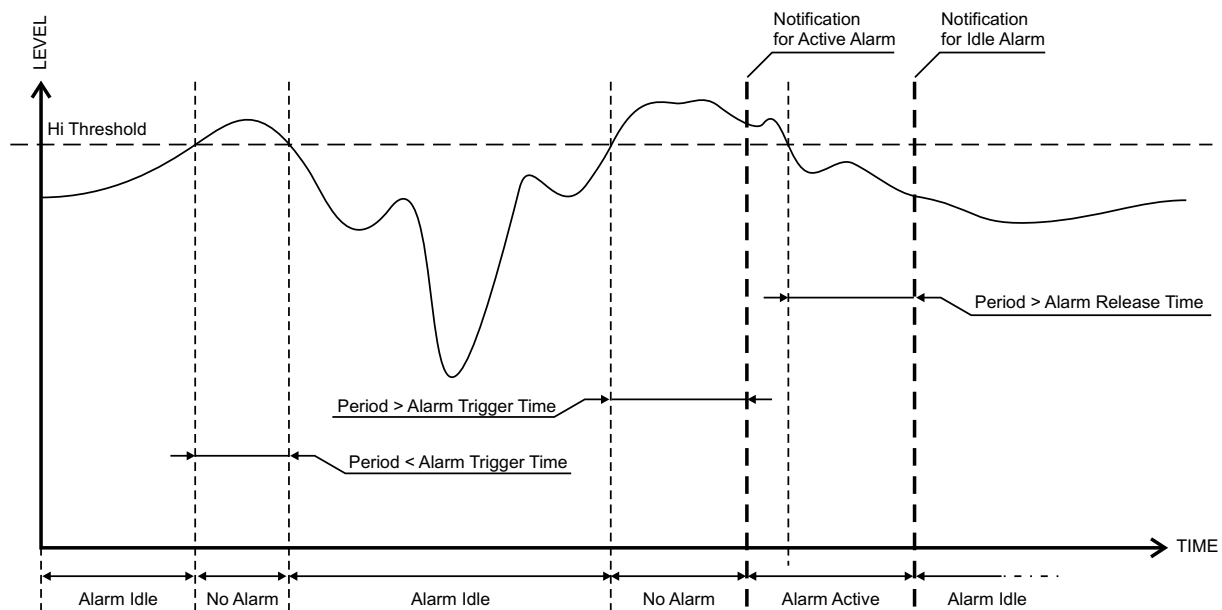

## ALARM NOTIFICATIONS

---

The E-mail, SNMP trap Alarm Notifications contain the following information - device's Alias, date and time of Alarm triggered, channel number, frequency and information about the Alarm activation/deactivation. The basic signal parameters are also included.

**Example for E-mal Notification:**

Date: 04 Nov 2018, 07:31:11

DB36 reports ACTIVE alarm on 0x1234 - Power FM (CH1)

Alarm: S/N Ratio < 16dB

Signal parameters:

RF: 31dBuV

DAB: LOSS

S/N Ratio: 0dB

CNR: 0dB

Left: -60.0dB

Right: -60.0dB

FIC Quality: 0%

## APPENDIX B

### HOW SHOULD I CONFIGURE THE CONNECTION BETWEEN MY DEVA DEVICE AND AN FTP CLIENT?

---

In order for a connection to be established the following setting should be applied:

#### 1. FTP Server Settings

The built-in FTP Server has four important parameters that should be configured: Command Port, Data Port, User name and Password. These parameters are to be used in the FTP client's connection configuration. Further information on how to change the FTP Server's settings and their respective default values can be found in the device's User manual.

**WE RECOMMEND** the usage of FileZilla (<https://filezilla-project.org>). This is a widespread open source software distributed free of charge, hence available for downloading from the Internet.

**NOTE:** The FTP Server can manage only one connection at a time. The FTP Server works in Passive mode. Hence, the FTP Client should also be set in passive mode.

#### 2. IP Router and Port Translation Settings

If the connection to the device is made through a Network address translation (NAT) router or firewall, the port forwarding feature of the router should be configured. The port forwarding is usually set in the firewall section of the router's menu. As each router has different port forwarding procedure, we recommend you to refer to its complete manual. To allow proper data flow through the router, the FTP Command and FTP Data ports should be open.

**NOTE:** The FTP port numbers to be used in the port forwarding feature configuration can be found in the device.

### 3. Example of FTP Client (FileZilla) Settings

In some cases, FileZilla's "Quick connect" feature is not able to connect with the DEVA unit. That is why we recommend the device to be assigned in the program manually.

Enter the FTP Client and go to: **File > Site manager > New Site**. A dialog box requiring obligatory information about the device will appear. Fill in the needed information and press "OK".

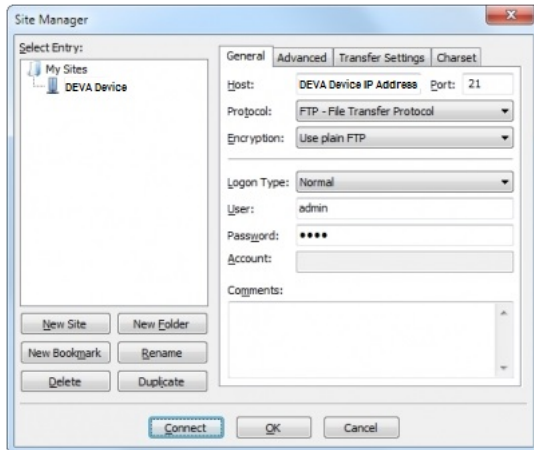

Select "Transfer Settings" sub-menu and apply the settings as shown below:

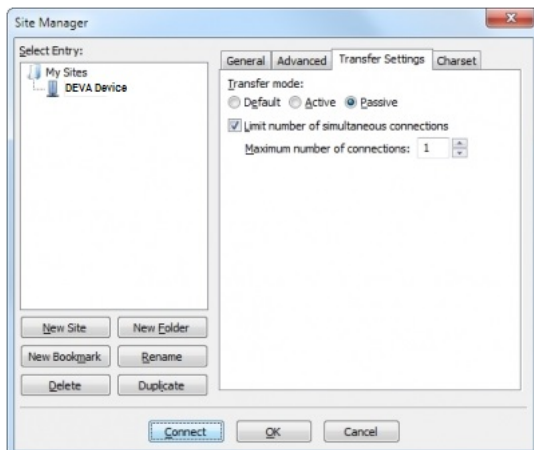

## WARRANTY TERMS AND CONDITIONS

**I. TERMS OF SALE:** DEVA Broadcast Ltd. products are sold with an understanding of “full satisfaction”; that is, full credit or refund will be issued for products sold as new if returned to the point of purchase within 30 days following their receipt, provided that they are returned complete and in an “as received” condition.

**II. CONDITIONS OF WARRANTY:** The following terms apply unless amended in writing by DEVA Broadcast Ltd.

**A.** The Warranty Registration Card must be completed and returned to DEVA Broadcast Ltd. within 10 days of delivery. Product registration can also be done digitally at <https://www.devabroadcast.com/members/product-registration>, after registering on our website, within 10 days of delivery.

**B.** This Warranty applies only to products sold “as new.” It is extended only to the original end-user and may not be transferred or assigned without prior written approval by DEVA Broadcast Ltd.

**C.** This Warranty does not apply to damage caused by improper mains settings and/or power supply.

**D.** This Warranty does not apply to damage caused by misuse, abuse, accident or neglect. This Warranty is voided by unauthorized attempts at repair or modification, or if the serial identification label has been removed or altered.

**III. TERMS OF WARRANTY:** DEVA Broadcast Ltd. products are warranted to be free from defects in materials and workmanship.

**A.** Any discrepancies noted within TWO YEARS of the date of purchase will be repaired free of charge, or the equipment will be replaced with a new or remanufactured product at DEVA Broadcast Ltd. option.

**B.** Parts and labor for factory repair required after the two-year Warranty period will be billed at prevailing prices and rates.

### IV. RETURNING GOODS FOR FACTORY REPAIR:

**A.** Equipment will not be accepted for Warranty or other repair without a Return Material Authorization (RMA) number issued by DEVA Broadcast Ltd. prior to its return. An RMA number may be obtained by placing an RMA request at <https://www.devabroadcast.com/rma>. The number should be prominently marked on the outside of the shipping carton.

**B.** Equipment must be shipped prepaid to DEVA Broadcast Ltd. Damage sustained as a result of improper packing for return to the factory is not covered under terms of the Warranty and may occasion additional charges.

### V. UPDATES TO THE TERMS OF SERVICE:

For the most up-to-date, valid, and accurate terms, conditions, and product documentation, please visit the official DEVA Broadcast Ltd. website downloads section at <https://www.devabroadcast.com/downloads/deva-documents>. Printed documents may not reflect recent amendments. Reviewing the current online versions ensures you have the latest information.



## PRODUCT REGISTRATION CARD

- All fields are required, or warranty registration is invalid and void

Your Company Name \_\_\_\_\_

Contact \_\_\_\_\_

Address Line 1 \_\_\_\_\_

Address Line 2 \_\_\_\_\_

City \_\_\_\_\_

State/Province \_\_\_\_\_ ZIP/Postal Code \_\_\_\_\_

Country \_\_\_\_\_

E-mail \_\_\_\_\_ Phone \_\_\_\_\_ Fax \_\_\_\_\_

Which DEVA Broadcast Ltd. product did you purchase? \_\_\_\_\_

\_\_\_\_\_  
\_\_\_\_\_

Product Serial # \_\_\_\_\_

Purchase date \_\_\_\_ / \_\_\_\_ / \_\_\_\_

Installation date \_\_\_\_ / \_\_\_\_ / \_\_\_\_

\_\_\_\_\_  
Your signature\*

\*Signing this warranty registration form you are stating that all the information provided to DEVA Broadcast Ltd. are truth and correct. DEVA Broadcast Ltd. declines any responsibility for the provided information that could result in an immediate loss of warranty for the above specified product(s).

**Privacy statement: DEVA Broadcast Ltd. will not share the personal information you provide on this card with any other parties.**