

MAINTENANCE AND OPERATION
INSTRUCTION MANUAL

DB4005

SDR-Based FM Radio Modulation Analyzer
and Monitoring Receiver



Contents

Introduction	6
Typographic conventions	7
General Information	8
Product Features	9
<i>Technical Specifications</i>	10
<i>Block Diagram</i>	12
Safety Warning	13
Operating Recommendations	14
<i>Installation Specifications and Precautions regarding the RF Environment.</i>	
<i>Antenna Consideration</i>	15
AC Mains Power	16
<i>Fuse holder</i>	16
<i>Mains Voltage Selector</i>	16
<i>Power cord</i>	16
<i>Ground Loops</i>	16
Unpacking and inspection	17
Mounting	17
<i>Rack Requirements 1U</i>	17
<i>Rack Requirements Compact Units</i>	17
<i>Stand-Alone Devices</i>	17
Getting Started	18
<i>Connection</i>	18
<i>Network Settings</i>	19
<i>Network Discovery</i>	19
<i>Network Security Recommendations</i>	20
Panel Indicators, Switches and Connectors	21
<i>Front Panel – Left and Right Areas</i>	21
<i>Left Area</i>	21
<i>Right Area</i>	21
<i>OLED Display</i>	21
<i>Soft Buttons</i>	21
<i>Navigational Buttons</i>	21
<i>Rear Panel</i>	22
<i>Rear Panel Alarm Terminal</i>	23
Operation	24
<i>A Word about Measurement Limitations</i>	24
<i>Signal Strength</i>	24
<i>Multipath Distortion</i>	24
<i>Co-channel Interference</i>	25
<i>First Time POWER ON</i>	26
<i>Front Panel – Readout Section (Left Side)</i>	27
<i>Phones</i>	27
<i>Bargraphs and LED Indicators, Select Buttons</i>	27
<i>FM Modulating Metering</i>	27
<i>Select Button</i>	27

<i>Audio Demod Metering</i>	27
<i>L, R, L+R, L-R</i>	28
<i>Loss</i>	28
<i>Front Panel - LCD Display, Navigational & Soft Buttons (Right Side)</i>	29
<i>Display</i>	29
<i>Header Area</i>	30
<i>Soft Buttons</i>	31
<i>Main Screen Working Area</i>	32
<i>Operating Modes and Pages</i>	33
<i>Home Page</i>	33
<i>“Preset” explained</i>	33
<i>Creating a new Preset</i>	33
<i>Bandscan Page</i>	34
<i>Span control state:</i>	36
<i>Marker control state:</i>	38
<i>Parameter control state:</i>	39
<i>FFT Page</i>	40
<i>Scope Page</i>	42
<i>Measure Stereo page</i>	43
<i>Graphs page</i>	44
<i>Levels page</i>	46
<i>RDS decoder page</i>	50
<i>Settings page</i>	52
<i>How to change the tuning range</i>	55
<i>How to start a Logger campaign using the front panel menu?</i>	58
WEB Interface	59
<i>Manual IP Address Identification</i>	59
<i>Network Discovery</i>	60
<i>Access</i>	60
<i>Main Screen</i>	61
<i>RDS/RBDS Screen</i>	62
<i>FM Graph Screen</i>	63
<i>MPX Screen</i>	64
<i>Loudness</i>	65
<i>Spectrum Screen</i>	66
<i>Scope Screen</i>	67
<i>Bandscan Screen</i>	68
<i>Status Screen</i>	69
<i>Log Screen</i>	70
<i>Intruder</i>	71
<i>Monitoring</i>	72
<i>General Settings Screen</i>	73
<i>Tuner Settings Screen</i>	74
<i>Alarms Settings Screen</i>	75
<i>Alarm Notifications</i>	76
<i>Alarm</i>	76
<i>Logger Settings Screen</i>	77
<i>Logger Channel Settings</i>	78

Channel.....	78
Alarm Notification Type.....	79
Alarm	79
Export.....	79
Import.....	79
How to start a Logger campaign?	80
Communication Settings Screen.....	82
Network.....	82
HTTP Server.....	82
FTP Server.....	82
SNMP Agent	83
Syslog.....	83
GSM Modem.....	83
Application Server.....	83
Audio Stream Server	83
E-mail.....	84
UECP Relay.....	84
USB Port.....	84
Outputs Settings Screen.....	85
Other Settings Screen.....	86
Firmware Update	86
Storage.....	86
System Log.....	86
Factory Defaults	86
Reboot.....	86
APPENDIX A.....	87
List of DB4005 settings.....	87
APPENDIX B.....	95
Alarm Triggers	95
Alarm Notifications	97
APPENDIX C.....	98
How should I configure the connection between my DEVA Device and an FTP Client?	98
1. FTP Server Settings.....	98
2. IP Router and Port Translation Settings.....	98
3. Example of FTP Client (FileZilla) Settings.....	99
APPENDIX D.....	100
GSM Modem Option - Features and Usage.....	100
Short message services available.....	101
Remote Audio Listening	101
Remote Status Request	102
Initialization procedure for Sierra Wireless AirLink FXT009 GSM modem	103
1. Setting up the modem.....	103
2. Connecting with DEVA Unit.....	105
WARRANTY TERMS AND CONDITIONS.....	106
Product Registration Card.....	107

THIS PAGE
IS INTENTIONALLY
LEFT BLANK

Introduction

DEVA Broadcast Ltd. is an international communications and high-technology manufacturing organization, its corporate headquarters and facility located in Burgas, Bulgaria. The company serves the broadcast and corporate markets worldwide – from consumers and small businesses to the largest global organizations. It is dedicated to the research, design, development and provision of advanced products, systems and services. DEVA launched its own brand back in 1997 and has nowadays evolved to become known as a market leader and internationally reputed manufacturer of user-friendly, cost-effective and innovative broadcast products.

Creativity and innovation are deeply woven into DEVA corporate culture. Through successful engineering, marketing and management our team of dedicated professionals creates future-oriented solutions to improve customers' performance. You may rely that all issues communicated to our crew would be addressed accordingly. We pride ourselves on our pre and post-sales support and purchase services, which along with the outstanding quality of our radio gear have won us due respect and the market authority position.

DEVA best-of-breed solutions have become the best sellers for our partners. The strategic partnerships which have been formed with industry leaders during all these years that we have been operating on the broadcasting market, have proved us a reliable business partner and a valuable asset, as our dealers worldwide would confirm. In constant pursuit of precision and long-term satisfaction, DEVA enhances the reputation of our partners and clients alike. Furthermore, we have already a proven merit as a credible partner provider.

Our portfolio offers complete line of high quality and competitive products for FM and Digital Radio, Radio Networks, Telecommunication Operators and regulation authorities. For almost two decades of intensive software and hardware development, we have achieved a unique price-performance and endurance of our product lines. Our company's multitude of equipment and services is in line with the latest technologies and key trends. The most recognizable characteristics attributed to DEVA products are their clear-cut, streamlined design, easiness of use and cost-effectiveness: simplicity of forms but multiplicity of functions.

For us there is no stage when we deem that we have reached the most satisfactory level in our work. Our engineers are in constant pursuit of new ideas and technologies to be captured in DEVA solutions. Simultaneously, a strict control is being exercised at each step of any new development. Experience and hard work are our fundament but the continuous improving process is what we never leave aside. DEVA participates on a regular basis in all landmark broadcasting events, not only to promote its products, but to exchange valuable know-how and experience. We are also engaged in international large-scale projects involving radio and audio solutions which makes us even more competitive on the global market.

All DEVA products are developed and produced in accordance with the latest ISO 9001 quality control standards.

Typographic conventions

The following table describes important conventions used in the manual.

Convention and Style	Description	Examples
<i>Menu > Sub Menu > Menu Command</i>	A menu item(s) and menu command that you need to click in sequence	Click <i>Settings > General</i>
[Button]	Interface Interactive buttons	Press [OK] to save the changes
NOTE	Important notes and recommendations	NOTE: The notification will appear only once
<u>“Reference Name” on Page XXX</u>	References and links	refer to <u>“New Connection”</u> (see <u>“Monitoring” on page 56</u>)
Example	Used when example text is cited	Example for E-mail Notification: Date: 04 Nov 2013, 07:31:11

General Information

DB4005 is DEVA Broadcast's third-generation digital FM Radio modulation analyzer and receiver, the result of long years of experience and a desire to always provide intelligent near-perfect solutions, while keeping pace with the very latest technological developments and trends.

With this product, upon demodulation of the FM signal, the RF signal is digitalized by the SDR FM tuner and all signal processing is achieved through sophisticated DSP algorithms. The high precision of the powerful digital filters used in this equipment enables the FM signal to be accurately and repeatedly analyzed with each device. An important asset to the DB4005 is the MPX input, which allows you to monitor external composite signals, regardless of whether they are from a composite STL receiver/stereo FM encoder, or from an off-air source. As this is a tool of great processing power, it provides detailed readings of all the multiplex FM signal components, while all measurements are refreshed simultaneously and synchronously.

Another useful feature of the DB4005 is the Loudness Meter, which allows for measurements to be shown as defined by ITU BS.1770-4 and EBU R128 recommendations, as the product supports both standards.

The DB4005 has an easy to read, high-resolution OLED graphical display and ultra-bright bargraph LED 60 segment indicators that allow reading the main signal parameters at a glance. The built-in oscilloscope represents the observed signal change over time and helps you visualize the most important signals participating in the process of demodulating and stereo decoding. Complementing the Oscilloscope mode, the Spectrum analyzer mode allows for spectral analysis of the input signal. Spectral components of the selected signal are determined on the basis of Fast Fourier Transform. MPX Power and all other level measurements are supported by measurement history data. Additionally, RDS information contained in the processed MPX signal is easily visualized and represented as RDS/RBDS Data and detailed RDS/RBDS Statistics.

Dependable off-air monitoring enables you to keep an eye on other stations as well as measure the important parameters of your own signal. The DB4005 is designed to support USB and LAN communication interfaces, allowing flexibility of the remote connection and control of the unit. The DB4005 is the most cost-effective way for regular monitoring of the quality and continuity of your station and up to 50 other FM Radio Stations, with many features such as TCP/IP connectivity, audio streaming, and automatic alerts for operation outside of predefined ITU-R ranges. In case of transmission failure, maintenance staff will be immediately alerted via e-mail, SNMP, or SMS, which signals the technicians to restore the normal service as soon as possible. The DB4005 allows you to monitor all RDS/RBDS and other signal parameters from everywhere via its communication channels TCP/IP, and allows for GSM Connectivity via the optional external GSM Modem. Easy channel status monitoring or audio listening from everywhere could be done through your mobile phone. With the Audio Stream Server you can even listen to, skim through, and record the audio from another station.

All the channel measurements and logs are saved on the internal device memory. The built-in FTP system manages the files in accordance with an assigned schedule. All the collected information is centralized in a database and can be revised, played back, and sent automatically to the qualified staff if need be. The Interactive Software-based Log Viewer tool allows very detailed control and analysis of any station from the list of monitored channels. The Band Analyzer function presents an overview of all FM signals available, plus the RF signal strength of these stations. Scans are possible within any section of the FM band in 3 different modes. The generated spectrum diagram shows the RF Level vs. the Frequency.

Product Features

- FM Band - User selectable, 87.1-108 MHz (CCIR), 65-74 MHz (OIRT), 76-95 MHz (Japan)
- Dual tuners with built-in RF attenuator
- Up to 100 dB μ V direct RF Antenna Input
- Selectable wide range IF filter bandwidth
- Built-in input for external MPX analysis
- Fully DSP-based core
- Built-in Loudness Analyzer
- Bright, accurate bar graph LED metering of the Modulation and Pilot Levels
- Total and independent Positive and Negative deviation bar graph
- Left, Right, L+R, L-R bar graph LED audio level meters
- Wide angle, easy to read OLED display
- Very Intuitive Navigational Menu
- Built-in Oscilloscope for IF, MPX, Pilot, RDS, Left & Right display
- Levels measurement with data history
- Spectrum analyzer allowing checking of the RF Carrier and MPX
- Selectable De-emphasis - Off, 50 μ s and 75 μ s
- Quick Station access via 4 Presets
- Built-in Stereo Decoder
- Real Time Audio Program Streaming
- Remote Listening via optional GSM modem
- Built-in 50 channel Data logger
- Built-in WEB and FTP server
- Easy to use WEB interface
- Apple and Android devices support
- SNTP for automatic synchronization of the built-in clock
- RDS and RBDS decoder with BER meter
- Alarm dispatch via E-mail, SMS, SNMP and GPO
- Complete status reporting with SMS via optional GSM modem
- Protected access to the device settings
- Level Adjustable, Balanced Analog Audio Outputs on XLR Connectors
- Professional AES/EBU, SPDIF and Optical Digital audio outputs
- LAN port for full TCP/IP remote control and monitoring
- Adjustable MIN/MAX alarms for RF, Pilot Left & Right Audio Levels
- Adjustable MIN/MAX alarms for MPX, MPX Power & RDS
- USB communication interface for local connectivity
- Headphone output with front panel level control
- Firmware updates will ensure improved operation
- Accurate front-panel metering for local use
- Restore Factory Parameters option
- Easy Installation and Setup
- Simultaneous Logger and Monitoring
- Intruder BandScan Alert

TECHNICAL SPECIFICATIONS

RF INPUT	
Tuning Range	User selectable, 87.1-108 MHz (CCIR), 65-74 MHz (OIRT), 76-95 MHz (Japan)
Tuning Step	10, 20, 50, 100 kHz
Tuner Sensitivity	30 dB μ V
Antenna Ports	Dual, 2 x BNC Connectors, 50 Ω
Antenna Ports Isolation	> 40 dB
Internal Attenuator	0, 10, 20 and 30 dB
Dynamic range	100 dB
FM DEMOD	
IF Filter Bandwidth	50kHz to 314kHz overall; ±25kHz to ±157kHz; 15 Increments
Frequency Response	±0.1 dB, 10 Hz to 86 kHz
MPX Power	±12 dB, 20 sec. integration
Dynamic range	90 dB
MPX INPUT	
Connector	BNC on rear panel
Impedance	10 k Ω
Frequency range	10 Hz to 70 kHz; ±0.01 dB, 100 Hz to 60 kHz;
Sensitivity	3.5 Vp-p @ 100%
STEREO DECODER	
Frequency Response (L and R)	±0.1 dB, 10 Hz to 15 kHz
SNR (Stereo)	60 dB, 50 μ s de-emphasis
THD	0.15%@1kHz, 0.4% – 10Hz-15kHz, 50 μ s de-emphasis
Separation	50 dB, 50 Hz to 10 kHz, 50 μ s de-emphasis
Crosstalk	52 dB
RDS DECODER	
Standards	European RDS CENELEC; United States RBDS NRSC
Error Correction & Counting	Yes
AF Decoding	Yes
CT (Time/Date)	Yes
PI, PTY, DI, MS	Yes
TA/TP	Yes
RT (Radio Text), RT+	Yes
PS (Program Service name)	Yes
TMC, ODA	Yes
Group Analyzer	Yes
BER Analyzer	Yes
Group Sequence Display	Yes
RDS RAW Data Display	Yes

FFT SPECTRUM ANALYSIS (RF, COMPOSITE, AUDIO)	
Signal Sources	RF (IF), MPX, Left, Right
FFT length	2048 points
Dynamic range	90 dB
SCOPE ANALYSIS (RF, COMPOSITE, AUDIO)	
Signal Sources	RF (IF), MPX, Pilot, RDS, Main, Sub, Left, Right
Record length	4096 points
Dynamic range	90 dB
METERING ACCURACY	
RF Level	±1 dB, 0 to 100 dB μ V
MPX Power	±0.2 dBr, -12 to 12 dBr, 0.1 dBr resolution
Total, Pos, Neg	±2 kHz, 10 to 100 kHz, 1 kHz resolution
Pilot, RDS	±0.5 kHz, 1 to 12 kHz, 0.2 kHz resolution
Audio	±1 dB, +10.0 to -55.0 dB, 0.1 dB resolution
OUTPUTS	
Audio (L, R)	+12 dBm, 600 Ω balanced XLR Connector
AES3 (L, R)	5.0 Vp-p, 110 Ω , balanced XLR Connector
SPDIF (L, R)	3.0 Vp-p, 110 Ω , unbalanced BNC Connector
Optical (L, R)	Transmitter, TOSLINK
Alarms	Programmable terminals on rear panel, optoisolated
Headphone	6,3mm (1/4") Phone Jack
COMMUNICATION INTERFACES	
USB	B-type Connector
Ethernet 10/100 Base-T	RJ45 Connector
GSM Modem	15 pin Male D-Sub Connector
MEASUREMENT STORAGE	
Storage	2GB Build-in Memory Card
Data format	Text, CSV
OPERATING CONDITIONS	
Temperature	-15°C to 55°C
Humidity	< 95%, non-condensing
Altitude	0 to 5000m above sea level
POWER	
Supply	100-240V / 50-60 Hz / 25W
Connector	IEC320
SIZE AND WEIGHT	
Dimensions (W;H;D)	485 x 44 x 180 mm, 19" x 1.7" x 6.9"
Shipping Weight	540 x 115 x 300 mm / 2.7kg

BLOCK DIAGRAM

A simplified block diagram of DB4005 is shown below

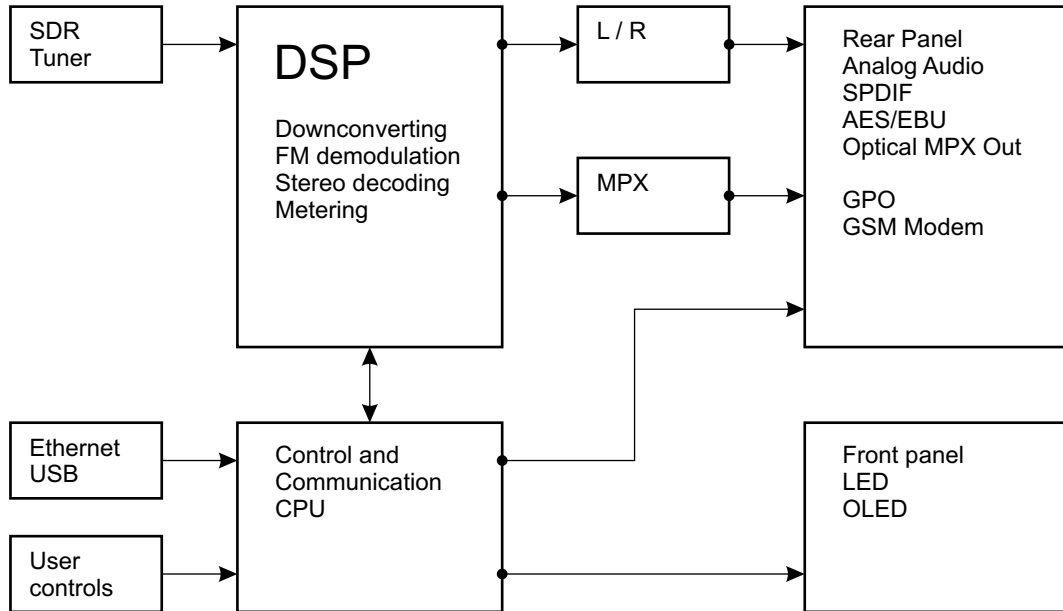

Because of the all-digital, minimalist-discrete-component nature of device circuitry, we have not provided schematic diagrams of the DB4005 in this Manual. Please, note that:

**NO USER-SERVICEABLE COMPONENTS INSIDE.
REFER ALL SERVICING TO
QUALIFIED TECHNICAL PERSONNEL.**

Safety Warning

ALWAYS OBSERVE THE SAFETY PRECAUTIONS.

Careful observance of the safety precautions will help prevent physical injury, damage of the equipment, and extend the equipment life.

- The servicing of electronic equipment should be performed only by qualified personnel;
- Before removing the covers the unit must be switched off and the mains cable unplugged;
- When the equipment is open, the power supply capacitors should be discharged using a suitable resistor;
- Never touch the wires or the electrical circuits;
- Use insulated tools only;
- Never touch the metal semiconductor. They might carry high voltages;
- For removing and installing electronic components, follow the recommendations for handling MOS components.
- Do not remove the factory sticker from the equipment. It contains information as regards the name, serial number and MAC address of the device.
- To join the equipment to the mains supply, use the power cord purchased with the equipment.

ATTENTION: The device has an internal Lithium battery. Do not try to re-charge this battery! In case the battery needs to be changed, please contact us for detailed instructions and information of the battery type.

Operating Recommendations

To ensure normal operation of the DEVA unit, we recommend following the instructions listed below.

- Install the unit in places with good air conditioning. The unit is designed to operate within the ambient temperature range of 10 to 50°C. The equipment rack should be ventilated in order for the device to keep its internal temperature below the maximum ambient temperatures;
- We do not recommend installation in rooms with high humidity, dusty places or other aggressive conditions;
- Although the device is intended to be installed closed to exciters or transmitters, we do recommend the device to be located away from abnormally high RF fields.
- Use only checked power supply cables. We strongly recommend the usage of shielded cables;
- Connect the DEVA unit to reliable power supply sources only. In case of unstable power supply, please use Uninterruptible Power Supply (UPS);
- Use the device only with its top cover on to avoid electromagnetic anomalies. Otherwise, this may cause problems with the normal functionality of the unit;
- To ensure normal remote operation of the unit, make sure to connect the device to a good quality Internet connection;
- For the normal operation of your DEVA device, check if the network settings past through all the required data traffic.

INSTALLATION SPECIFICATIONS AND PRECAUTIONS REGARDING THE RF ENVIRONMENT. ANTENNA CONSIDERATION.

Attentively observing of the RF Environment, in which DB4005 is disposed and is functioning, is necessary for ensuring of the normal and reliable working of the system. Best conditions in accordance with the standards listed below must be provided for functioning of the system.

Depending on the application, the DB4005 monitoring receiver can be installed very close to high power FM transmitters. Usually its antenna port is directly connected to any FM transmitter monitor output or to directional coupler on the output of any combiner system. The typical RF output level of such sources is too high for the normal operation of the DB4005 receiver. We strongly recommend using external RF attenuators with attenuation value between 20 – 90dB for reaching optimal RF output level in the 55-60 dB μ V range.

Using external antenna is required when the DB4005 receiver is used for off air monitoring too far from any transmitters or transmitter site. Very important step in such case is selecting the proper outdoor FM antenna, antenna location and direction. The three most popular antenna types are: omni directional, unidirectional dipole and directional multi-element array antenna.

The omni directional Antenna is not a good choice for using with DB4005, because of the low antenna gain, the very bad signal to noise ratio (compared to any directional antenna) and its high multipath interferences reception.

The other type antennas: unidirectional dipole and directional multi-element array antenna have some directivity and antenna gain. These factors make these antennas much proper for your needs. We recommend the usage of factory made antenna or antenna system, manufactured especially for the currently selected FM Band - 87.1-108 MHz (CCIR), 65-74 MHz (OIRT), 76-95 MHz (Japan).

After selecting the antenna type that will meet your needs, the next step is the installation of the antenna. You must follow several important principles:

- Install the antenna far enough from any walls, roofs, buildings or any transmitting equipment;
- The minimum spacing between the antenna and the closest object must be more than 3 meters.

One DB4005 monitoring receiver is usually used for the monitoring of one transmitter site, transmitting more than one program. In such cases the best antenna that can be used is a directional antenna directed exactly to this site.

If you would like to monitor more than one transmitter site, we recommend using antenna system with separate antennas for each of the monitored directions.

AC Mains Power

FUSE HOLDER

The fuse holder is placed inside the unit, next to the voltage selector. Apply downward pressure and pull the cap outward to access the 5mm mains fuse. The reverse process will release the cap.

MAINS VOLTAGE SELECTOR

Before connecting the AC Power, make sure that the internal Power Switch is in accordance with the mains supply at your location. The Power Supply Factory Settings are:

- 100 - 240 VAC
- 1 Amp Fuse

CAUTION: Permanent damage will result if improper AC supply voltage is applied to the device. The warranty DOES NOT cover damages caused by applying improper supply voltage or usage of improper fuse.

POWER CORD

The detachable IEC-type power cord is supplied with the unit. The individual cord conductors may be color-coded in either of two ways:

- 1) In accordance with US standards:
- BLACK = AC “HOT”
 - WHITE = AC NEUTRAL
 - GREEN = EARTH GROUND

- 2) To European CEE standards:
- BROWN = AC “HOT”
 - BLUE = AC NEUTRAL
 - GREEN/YELLOW = EARTH GROUND

GROUND LOOPS

Because the unbalanced INPUTS/OUTPUTS of the device are chassis-ground-referenced, a mains frequency or INPUT/OUTPUT ground loop could be formed between the input or output cable shield grounds and the AC power cord ground. A ‘ground-lifting’ AC adapter may help in this situation, although the chassis must be properly grounded for safety purposes. In general, the equipment being installed in a rack will satisfy the safety requirement.

Unpacking and inspection

Upon receipt, the equipment should be inspected for possible shipping damages. If such are found or suspected, notify the carrier at once and contact DEVA Broadcast Ltd. The original shipping carton box and packing materials should be kept for possible reuse, in case of return for Warranty repair, for example. Shipping damages as a result of improper packing for return may invalidate the Warranty!

The packing material (plastic bags, polystyrene, nails, etc.) must never be left within reach of children, as these items are potential sources of danger.

IT IS VERY IMPORTANT that the [“Product Registration Card”](#) included in the Manual be completed accurately and returned. This will assure coverage of the terms of the Warranty and it will provide a means of trace in case of lost or stolen equipment. In addition, the user will automatically receive SERVICE OR MODIFICATION INSTRUCTIONS from DEVA Broadcast Ltd.

Mounting

RACK REQUIREMENTS 1U

The unit mounts in a standard 19-inch equipment rack and requires only 1 $\frac{3}{4}$ inches (1U) of vertical rack space. In order the painted finish around the mounting holes to be protected, the use of plastic washers is recommended.

RACK REQUIREMENTS COMPACT UNITS

Our customized 1U 19-inch rack accessory provides a professional mounting option for up to three compact size DEVA units. It is made of milled aluminum and finished in black powder coat. Two extra blanking panels and set of mounting screws are provided with each rack bracket kit.

STAND-ALONE DEVICES

DEVA's stand-alone units (Radio Explorer series, BandScanner series, DVB Explorer) do not require additional tools or installation brackets.

Getting Started

In order for the normal operation of the DB4005 to be guaranteed, you will need fulfill the following conditions:

1. Standard Ethernet 10/100M connection;
2. Correctly assigned Network configuration and device settings.

To make sure that all the conditions are fulfilled please, follow the instructions below.

CONNECTION

1. Install the unit on its operation place;
2. Using the provided power cable, connect the unit to the power supply network;
3. Connect the antenna cable to the RF antenna input connector located on the rear panel of the device;
4. Connect the DB4005 to the TCP/IP network using direct network cable;
5. **IF GSM OPTION IS SUPPORTED** - Using the connection cable provided, connect the optional GSM modem. In order for better GSM network coverage to be achieved, please select proper place for the GSM antenna.

NOTE: The GSM antenna must be installed far enough from the monitoring devices. The GSM modem radiates RF signal that may cause spurious emissions that will may interfere with the accuracy of the measurements. For detailed explanation of the option, please refer to [“GSM Modem Option” on page 100](#).

NETWORK SETTINGS

After connecting the network cable the Led 'LAN' located on the rear panel must be ON or flashing. The next and most important step for configuration is the adjustment procedure of the Network Communication. The settings shown below are Default Network Settings:

DHCP	Enabled
IP	Assigned by DHCP
Mask	Assigned by DHCP
Gateway	Assigned by DHCP
DNS	Assigned by DHCP
HTTP Port	80

NETWORK DISCOVERY

This is a network setting that defines whether your computer can see (find) other computers and devices on the network and whether other computers on the network can see your computer. By default, Windows Firewall blocks network discovery but you can enable it.

1. Open Advanced sharing settings by clicking the Start button, and then on "Control Panel". In the search box, type "network", click "Network and Sharing Center", and then, in the left pane click "Change advanced sharing settings";
2. Select your current network profile;
3. Click "Turn on network discovery", and then click save changes.

NOTE: If you're prompted for an administrator password or confirmation, type the password, provide confirmation or contact your system administrator.

If you have already enabled this function on your computer DB4005 will be automatically added to the Device list section. The device will be ready for usage and no additional adjustments will be required except user name and password.

NOTE: If the port is different than the default one (80), it is necessary to specify it, for example:
`http://192.168.1.2:9000`

ATTENTION: Depending on Internet Protocol Settings, the assigned IP address may not be visible outside your local network, thus the device may be accessed only within that network. Consult with your network administrator for the appropriate IP settings.

NETWORK SECURITY RECOMMENDATIONS

1. It is not recommended the DB4005 to be directly connected to the Internet. This may lead to unregulated access and/or problematic operation of the device. To ensure secure connection, we recommend the device to be installed behind a router with an active firewall.
2. If remote access to the device is needed, we recommend using VPN to the router or the port of the relevant service (WEB, SNMP, Application, etc.) to be properly NAT forwarded.
3. If NAT forward is used, it is highly recommended random ports of your choice to be used. Not the standard ones (80 for WEB, 161 for SNMP, etc.).
4. Using DMZ connection is not recommended.
5. Make sure to change the standard access credentials (usernames and passwords, SNMP communities).

For detailed information as regards the recommendations listed above or need of further instructions, please contact your network administrator.

Panel Indicators, Switches and Connectors

FRONT PANEL – LEFT AND RIGHT AREAS

The DB4005 front panel can be provisionally divided into two main areas – Left Area and Right Area. A brief description of controls and switches, indicators and displays located in both areas is given below. For detailed information please refer to [“Operation” on page 24](#).

Left Area

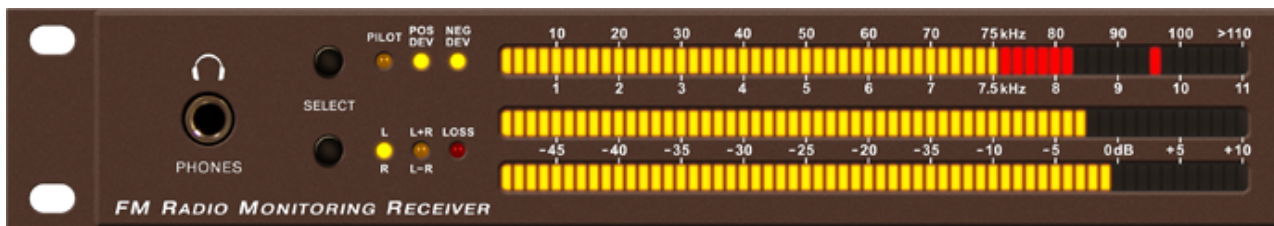

At the extreme left is located the Phones connector. Next to them are the sub areas of *FM MODULATION METERING* and *AUDIO DEMOD METERING* with the appropriate *SELECT* buttons and LED indicators. Both areas contain 60 segments LED bargraphs. The upper one is used to indicate the Total Deviation, the Positive or Negative deviations divided each other and the Pilot signal as well. The lower bargraphs are used to show the demodulated audio according to the mode selected by the *SELECT* button on the left of them.

Right Area



OLED Display

– signals received by DB4005 can be viewed and analyzed by the built-in OLED display. This is the display to visualize all the measurements of the received signal and show the various DB4005 settings.

Soft Buttons

– used to navigate through the menus, quickly access the parameters, modes and functions and to alter their values. Their functions vary in accordance with the selected menu. On the bottom side of the OLED display are located Soft Buttons indicators and they alter their meaning following the function currently selected by the Soft Buttons. Pressing of a Soft Button, causes a visual effect of pressing the appropriate button on the OLED Screen. Soft Buttons will be referred as *SB1* (leftmost one), *SB2*, *SB3* and *SB4* (rightmost one) further in this manual.

Navigational Buttons

– *UP* and *DOWN*, *LEFT* and *RIGHT* and *OK* buttons are used for frequency selection and similarly to the *Soft Buttons* to navigate through the menus selecting various functions and parameters of the DB4005.

REAR PANEL

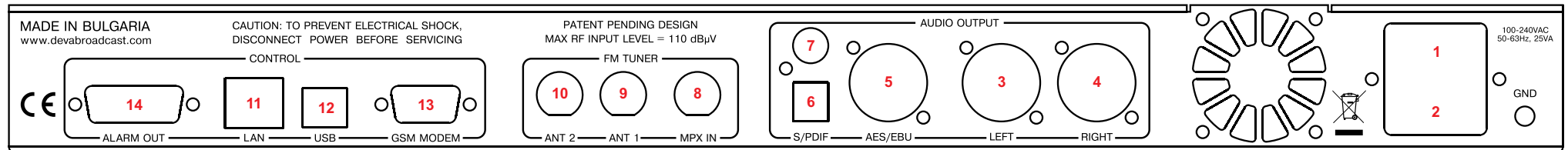

1. Mains connector, 110-240VAC, IEC-320 C14 type;
2. Fuseholder – 1A;
3. Audio Left Output – XLR;
4. Audio Right Output – XLR;
5. Audio AES/EBU Output – XLR;
6. Audio SPDIF Output – RCA;
7. Audio Optical Output – TOSLINK
8. MPX Input – BNC;
9. RF Input 1 (Antenna 1) – BNC;
10. RF Input 2 (Antenna 2) – BNC;
11. Ethernet T-BASE10/100 RJ45;
12. USB – type B;
13. GSM Modem – Male D-Sub 15 pins High Density;
14. GPO – Optoisolated, Female D-Sub 15 pins;

REAR PANEL ALARM TERMINAL

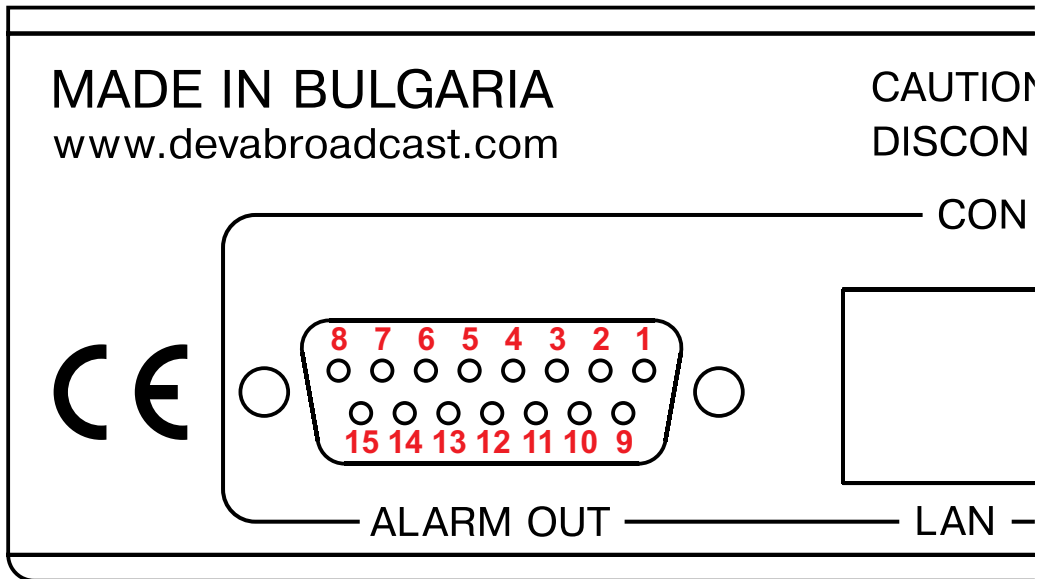

- 1 - GPO1 Collector
- 2 - GPO2 Collector
- 3 - GPO3 Collector
- 4 - GPO4 Collector
- 5 - GPO5 Collector
- 6 - GPO6 Collector
- 7 - GPO7 Collector

- 9 - GPO1 Emitter
- 10 - GPO2 Emitter
- 11 - GPO3 Emitter
- 12 - GPO4 Emitter
- 13 - GPO5 Emitter
- 14 - GPO6 Emitter
- 15 - GPO7 Emitter

8 - GND

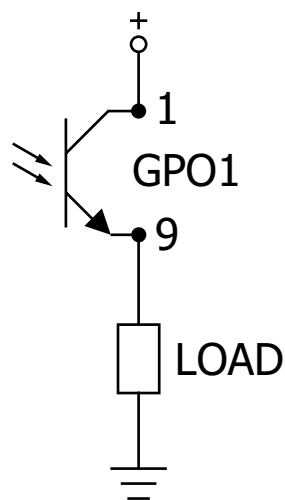
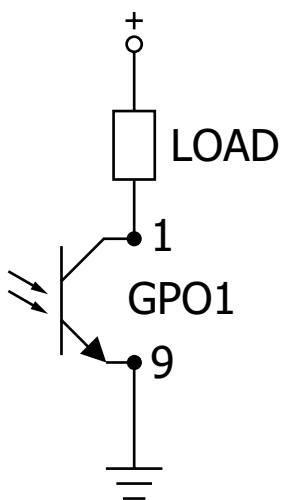

Operation

A WORD ABOUT MEASUREMENT LIMITATIONS

Signal Strength

Signal strength is a major factor when a signal is measured and evaluated. FM as compared to the AM is a much less susceptible to the inherent noise in radio reception.

On the other side speaking about FM broadcasting, it is the monaural reception which can tolerate and profit from a much narrower IF bandwidth. Stereo reception adds all the noise present in the 23 – 53 kHz sub-band. Moreover it is the amplitude component (AM) of this sub band that is converted down to audible noise to be added to the program signal. That is why the noise performance of FM-stereo can be as much as 20 dB worse than that of monaural broadcast.

As a general rule better reception and measurement can be obtained by using highly directional outdoors antenna. Such antenna besides improving the signal strength, will contribute in eliminating the multipath distortion.

A bargraph indicator used in DB4005 allows measuring the strength of the signal being received, where the rule “the more the better” is in force. To reach this indicator, activate *LEVELS* menu.

Multipath Distortion

In FM reception, regardless of overall signal strength, a very important consideration is that obstacles, (which an FM signal may encounter in the line-of-sight path) tend to reflect and disperse the signal in many directions. In many locations, especially in urban areas where many tall buildings interfere with the direct transmitted signal or in suburban areas surrounded by hills or mountains, an FM receiver may pick up a station’s primary signal but, also, several secondary reflections coming from various directions. These reflections arrive at the receiver out-of-phase, slightly delayed in time with the primary signal and tend to blur or distort the principal signal. The degree of distortion depends on the number and relative strength of the reflections.

The result, known as multipath distortion in FM reception can range from a low-level fuzziness to a severely distorted sound quality, particularly at the high frequencies or treble. Multipath distortion is especially troublesome in FM stereo reception.

DB4005 incorporates a multipath distortion detector and multipath bargraph indicator to show the multipath level of received signal. The so mentioned multipath bargraph can be reached under the *LEVELS* menu.

Co-channel Interference

In many populated areas, there just isn't much room in the radio spectrum and stations will be jam-packed in. Another thing which would result in mutual interference between the broadcasting stations is poor frequency planning.

The inherent broad bandwidth of the DB4005 receiver is vulnerable from stations working on the nearby frequencies, where signal strength will be the most important factor – the stronger the interfering station, the stronger the interference effect.

One method to identify adjacent channel interference is to observe independent positive and negative deviation readings. If the positive deviation is considerably higher than the negative one, interference from a strong station above the monitored frequency would be indicated and vice-versa. In this example the negative deviation can probably be trusted as an indication of total carrier modulation, though this should be confirmed in free of interference RF environment.

In any event program deviation should be fairly symmetrical about the carrier frequency. Using the built-in Attenuator can be of some help, but using of an outdoors directional antenna could dramatically improve the situation with unwanted adjacent working stations. Other solutions include a band-pass filter at the primary frequency or a trap at the interfering frequency.

FIRST TIME POWER ON

In this chapter we will try to give you a brief guidance on starting and initial setup up of DB4005. By this you will get initial understanding of procedures and measurements in daily use of DB4005.

For the beginning the items needed are a pair of headphones and a connection to an outside antenna. Considerations in the choice of antenna are described in details previously in this manual ([see “Installation Specifications and Precautions regarding the RF Environment. Antenna Consideration.” on page 15](#)).

Assuming that the Mains voltage at your location is in permitted range of 110-240 VAC, you can plug in the power cord free end into the wall socket. Now turn the *POWER* switch *ON*.

NOTE: The DB4005 powers-up to the last selected frequency. This frequency, along with some of the settings and parameters will be held by the DB4005’s non-volatile memory and used on switching on of DB4005.

Plug the headphones into the front panel jack *PHONES* and using the *LEFT*< or *RIGHT*> Navigational Buttons start tuning in. Find a strong local station that even with a short wire antenna could be clearly heard on the phones. If needed try repositioning the antenna in order to improve reception.

Regardless of the previous selections, both deviations (Positive and Negative) will be selected upon DB4005 powering on and both *POS DEV* and *NEG DEV* LED indicators of *FM MODULATING METERING* will be lighted. Although the *SELECT* button enables independent monitoring of positive and negative deviation, the DB4005 is in the default mode when both the *POS DEV* and *NEG DEV* indicators are lighted. Unless there is a reason for doing otherwise the *FM MODULATION METERING* display should be kept in the default mode for the most exact measurement of the station’s carrier deviation.

The above are just the very first, basic steps in DB4005 operation. Detailed explanation of tuning, setting up and measurement procedures are given in the next chapters.

FRONT PANEL – READOUT SECTION (LEFT SIDE)

Phones

Phones jack to monitor the received signal. Headphones volume can be menu adjusted by going to **Settings > Audio / MPX Outputs > Phones Volume**.



Bargraphs and LED Indicators, Select Buttons

FM Modulating Metering

– 60 segments LED bargraph indicator to visualize the highest Positive or Negative deviation or both of them (default) as selected by the *SELECT* button. It is peak-responding, and it updates-and-holds the highest peak. When both the *POS DEV* and *NEG DEV* indicators are lighted, the highest deviation in either polarity is shown and this is the default display mode. *SELECT* button also switches the bargraph to display the injection level of 19 kHz stereo pilot signal, which is usually set to 7-8 kHz injection. Stereo *PILOT* signal is read on the lower metering scale. It is calibrated in appropriately smaller scale than the carrier deviation.

Select Button

– used to change mode of the LED bargraph indicators and associated LED indicators. Possible selections are *POS DEV*, *NEG DEV*, *POS DEV + NEG DEV*, *PILOT*.

Audio Demod Metering

– two 60 segments LED bargraphs showing *Left* and *Right* or *L+R* and *L-R* demodulated audio. By default the *AUDIO DEMOD METERING* displays left- and right channels of the stereo pair with the *L / R* indicator lighted. It is recommendable leaving this display in the default mode. The *SELECT* button can be used to switch the *AUDIO DEMOD METERING* display between *L / R* and *L+R / L-R*. Upon selecting any of the *L / R* or *L+R / L-R* the relevant indicator will light, but the headphones will continue monitoring the *L / R* stereo program.

Although there are instances where the *L+R* and *L-R* bargraphs may be close in value, as a rule of thumb, the *L-R* meter should generally lag the *L+R* meter by at least a few dB, i.e. the *L+R* sum will always have more energy than the *L-R* difference and this applies to nearly all recorded music. For signals where voice announcements are predominant, without background music or for other mono sources the *L-R* indication may drop almost off-scale.

The *SELECT* button associated with the above described bargraphs, cycles amongst various options, each of them identified with an associated LED indicator.

L, R, L+R, L-R

– LED indicators associated with *AUDIO DEMOD METERING* scales and indicating currently selected mode.

Loss

– indicating that the audio of the Left and/or Right stereo channel is lost. DB4005 can detect program audio loss and alarm is initiated whenever any of the Left or Right channels of the stereo pair drops below selected threshold for certain time. The *LOSS* detection threshold level and time can be adjusted from *Settings > Device > Loss* menu.



This function is not affected by the *SELECT* button.

FRONT PANEL - LCD DISPLAY, NAVIGATIONAL & SOFT BUTTONS (RIGHT SIDE)

Display

The DB4005's OLED display has three function areas: Header, Soft Buttons and Main Screen Working area.



OLED Display with its function areas

Header Area

Header is located on the left quarter of the screen. Depending on contents of working area the header may contains the following items:

99.90 FM - Frequency Indicator showing the currently selected frequency is located in the upper left corner. Frequency's resolution is 0.01 MHz;

IN ANT 1 - Currently selected active RF or MPX Input.
ANT 1 – signal being processed is the one from the Antenna 1 Input. *MPX* – input from MPX Input;

ATT 10 - Attenuator Indicator – showing the currently selected position of the active Input. Attenuator's position can be set manually by the operator or automatically be the DB4005.

STEREO 50µ - Indicator for Stereophonic Information contained in the received signal and currently selected de-emphasis time constant.

RDS - Indicator for RDS information contained in the received signal.

VERONIKA - Decoded *PS* information from RDS signal;

RF - Indicator to show the signal level at the antenna input;

VOL - Indicator to show the phones audio level;

IF BW - Indicator to show currently selected IF band-pass filter bandwidth;

Having three different de-emphasis selections, the question arises which one to select? As well known, one of the problems with the high quality VHF FM transmissions is that the increased audio bandwidth means that background noise can often be perceived. It is particularly noticeable towards the treble end of the audio spectrum, where it can be heard as a background hiss. To overcome this it is possible to increase the level of the treble frequencies at the transmitter. At the receiver they are correspondingly attenuated to restore the balance. This also has the effect of reducing the treble background hiss which is generated in the receiver. The process of increasing the treble signals is called pre-emphasis, and reducing the treble signals in the receiver is called de-emphasis. The rate of pre-emphasis and de-emphasis is expressed as a time constant. It is the time constant of the capacitor-resistor network used to give the required level of change. In the UK, Europe and Australia the time constant is 50µs whereas in North America it is 75µs.

So it can be selected depending on the region you are located or to completely disable this feature.

Soft Buttons



Soft buttons are located on the bottom side of the OLED Display making possible direct transition from some of the pages to another page. In such cases the inscription of a specified *Soft Button* corresponds to the page it is linked with. Most of the pages have the same or similar functionality distinctive segments (areas). Pressing of a specified *Soft button* causes a visual effect of pressing the appropriate *Soft button* on the OLED Display. Function, Menu Page, Parameter to be changed, etc., that are linked to a specified *Soft button* will appear as inscription on the button.

Example:

Cancel	- discard changes being made;
91.10MHz	- applying stored preset frequency;
Home	- HOME PAGE will be selected;
Back	- return to previous page;
Low ON	- alternating low threshold button;

NOTE: On some pages the *Header* and *Soft button* area may be hidden.

Main Screen Working Area

The Main part of the OLED Screen is the place where the information changes dynamically, depending on the selected working mode. The *Menu Screen* (shown below) appears after a short pressing of the “OK” Navigational Button. The DB4005’s *Menu Page* contains selectable icons and software buttons for selecting modes and functionalities of this device. Pressing *Left* and *Right* arrow buttons changes icon selection of the *Menu Page*. An icon is selected when it receives the rectangle focus frame around it. Short pressing of the “OK” button on selected icon will make a transition to corresponding page. On figure below the *Bandscan* icon is selected.



The following Operating Modes and Pages can be selected using the Navigational Buttons:

- Home page
- Bandscan page
- FFT page
- Scope page
- Stereo page
- Settings page
- Graphs page
- Levels page
- Status page
- About page
- RDS Decoder page

OPERATING MODES AND PAGES

Home Page



Immediately after power-up and boot process of DB4005, the *Home page* is shown on the display. Transition to *Home page* can be made from any page where **Home** Soft Button is available. There is several *Home page* views available which can be altered through **Settings>Device>Home Screen** menu.



On the default *home screen* the *Header area* is shown (see [“Header Area” on page 30](#)). Shown are also the most important flags attributes of the decoded RDS signal (if present) and big indicator of currently selected frequency. Pressing any of the *Soft Buttons* will set to the appropriate preset.

“Preset” explained

PRESET is a pre-saved set of parameters for instant automatic recall later on.

Creating a new Preset

Navigate to page of the DB4005 in which *Soft Buttons* are assigned to *Preset*. In such page the labels of the soft buttons are *FM Frequencies* (e.g. *Home page*). Select desired frequency by the Navigational Buttons and press hold *Soft Button* for about 2 seconds until two short beeps are heard from DB4005. A new *Preset* was created with parameters corresponding to those at the time of creation – *FREQUENCY*, *ATT*, *ANTENNA PORT*. The newly created *Preset* is assigned to the *Soft Button* and *Preset frequency* is shown as button label.

Bandscan Page

Select *Bandscan* icon from *Menu page* and short press *OK* button on it. The transition to *Bandscan page* will be made.



The data from last **bandscan** since DB4005 power-up will be shown on the display.

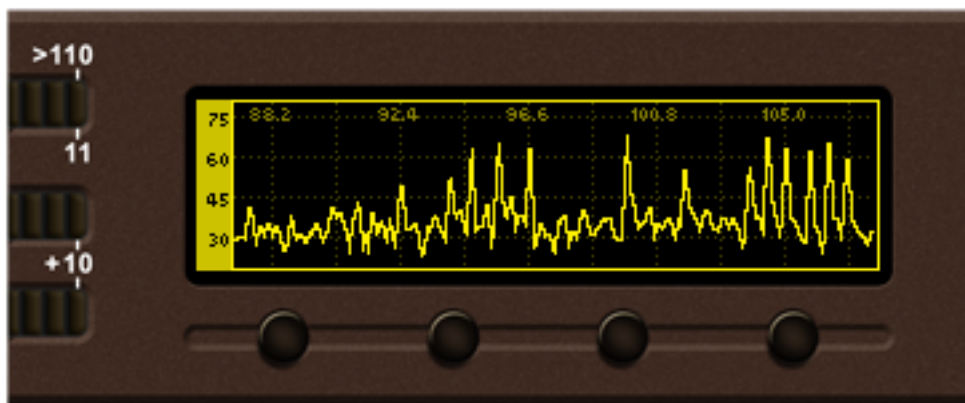

If there is no data from previous **bandscan** the empty grid will be displayed.

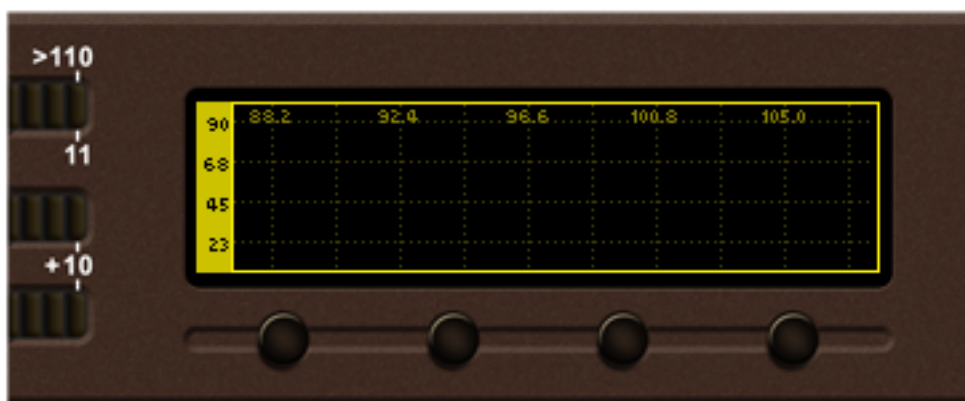

Since more space for data plot is needed the *Header area* is not shown on that page. The labels of the *Soft buttons* are hidden automatically short time after soft button is released. There is three control states in *Bandscan page* – *Span control*, *Marker control* and *Parameter control*. The states can be identified by the labels of the *Soft buttons*. If the labels appears as shown on the figure below that mean the page is in *Marker control* state.

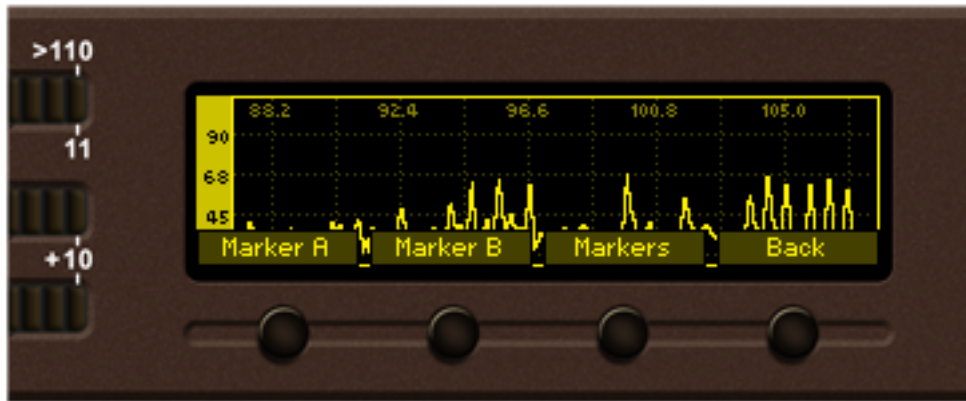

Short pressing *SB3* once will make the transition from *Marker* to *Span* control state and *Soft button* labels will be changed accordingly.

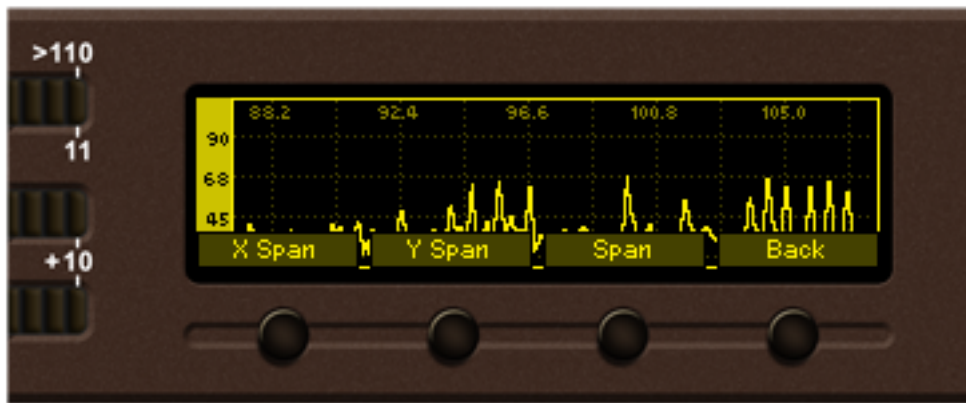

The controls state of the page will be changed alternatively between *Marker* and *Span* on every *SB3* press.

Short pressing *OK* button in either *Marker* or *Span* control states will make a transition to *Parameter* control state. The page will stay in that state until *OK* button is pressed again or a timeout of 2 seconds is elapsed (whichever occurs first). Simplified state diagram of the control states transitions is shown on figure below.

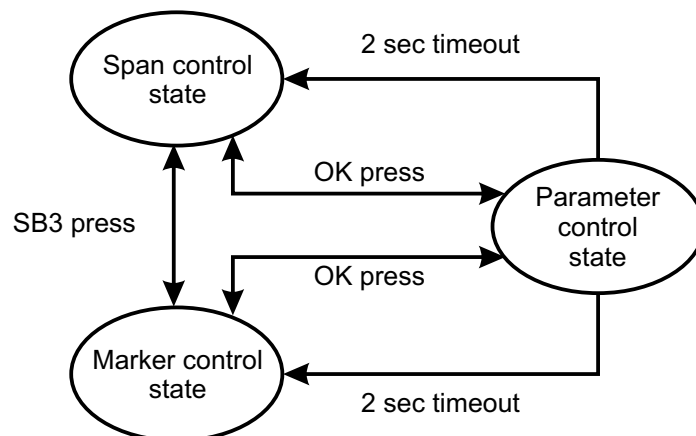

Span control state:

In this state *SB1*, *SB2* and *Arrow buttons* controls **span** of the data plot. The following is description of button assignments in span control state:

X Span (*SB1*) cycles through available **span** values for X axis of the data plot. Possible values are between 3 and 21 MHz in 1 MHz increments. Note that changing **X span** may also change the **center frequency** to keep data plot in bounds. On each key press next **span** value is selected and displayed briefly on the screen.

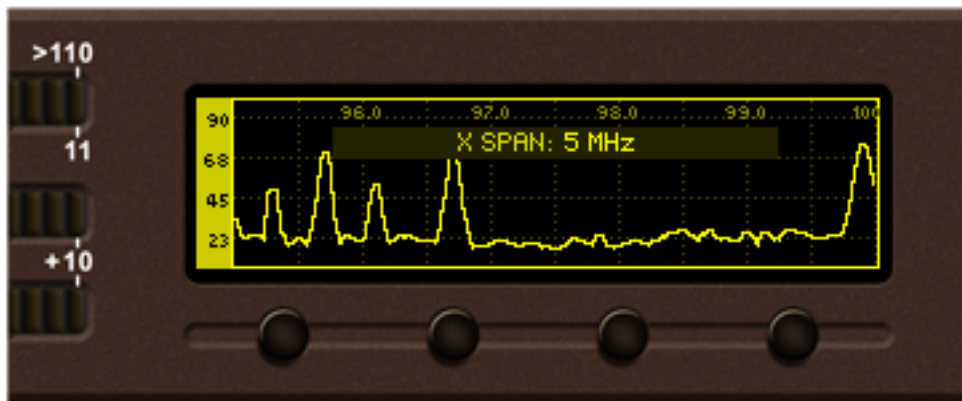

5MHz X span is selected

Y Span (*SB1*) cycles through available **span** values for Y axis of the data plot. Possible values are 30, 60, 90, and 120 dB μ V. Note that changing **Y span** may also change the **Y reference** to keep data plot in bounds. On each key press newly selected value is displayed briefly on the screen.

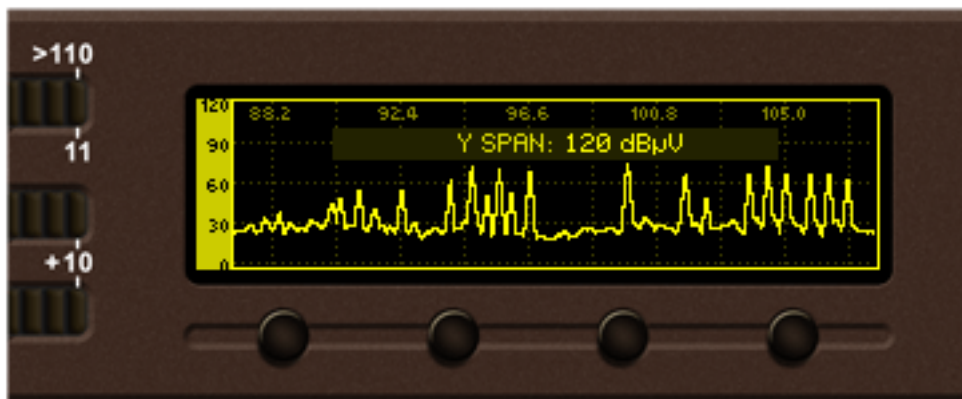

120 dBµV Y span is selected

Left / Right Buttons – changes **center frequency** of the data plot on 500 kHz increments. Permitted values for **center frequency** depends from currently selected **X span**. Selected value for **center frequency** is briefly displayed on the screen.

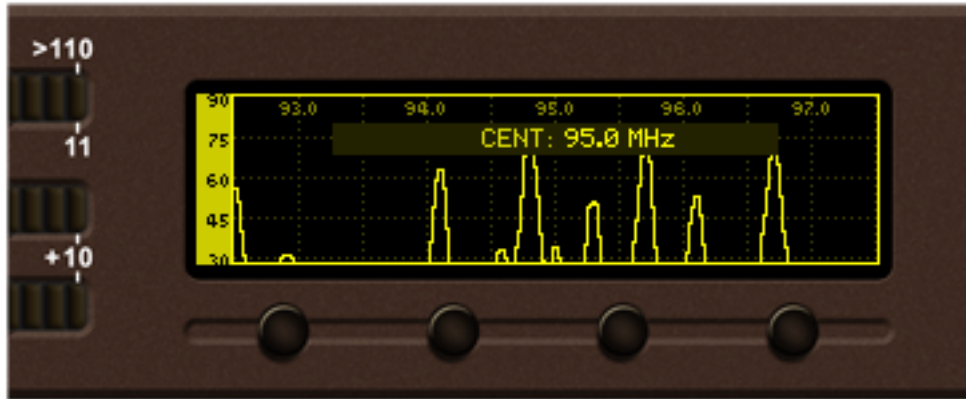

95 MHz center frequency is selected

Up / Down Buttons – changes Y axis reference (the value for the bottom of the Y scale). Permitted values are from -20 dBμV in 10 dBμV increments. The upper limit of Y reference depends from currently selected Y span. Selected Y reference is briefly displayed on the screen.

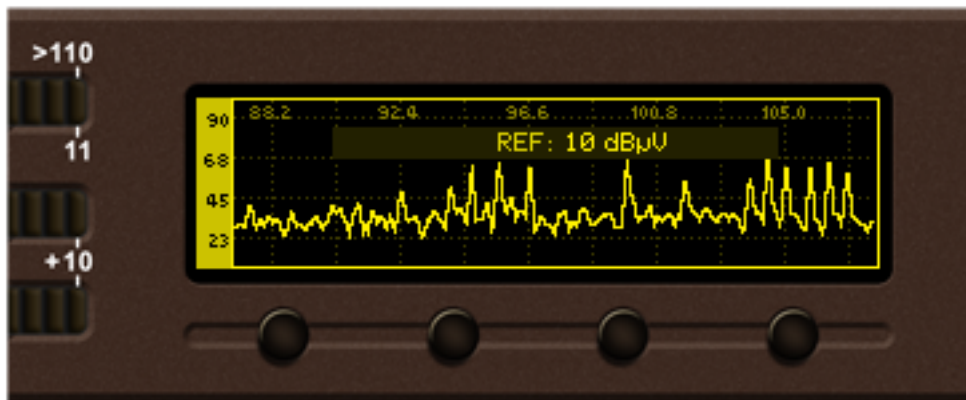

10 dBμV reference is selected.

Marker control state:

Up to two **markers**, named “A” and “B” are available in *Bandscan page*. *SB1, SB2, Left* and *Right buttons* controls the visibility and position of the *Markers*.

Button assignments:

Marker A (SB1) / **Marker B** (SB2) controls *Marker A* / *Marker B* appearance. There is three states of each marker:

- hidden – **marker** is not visible;
- shown – **marker** is visible but is not selected;
- selected – **marker** is visible and selected.

For **markers** in visible state (shown or selected) a readout for X and Y axes appear on the left side of the data plot. If both **markers** are visible the differential “*Marker B – Marker A*” values become available at the bottom left.

Selected **marker** is drawn with highlighted dashed line, the **marker** readout is highlighted also. There can be only one selected **marker** at the time. If only one **marker** is visible it is always selected.

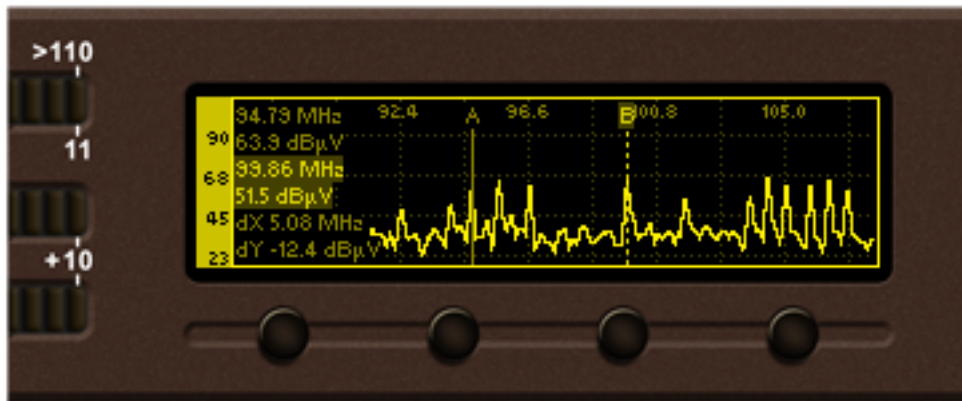

Marker A is shown, Marker B is selected

The logic of transition between these states is explained in following diagram:

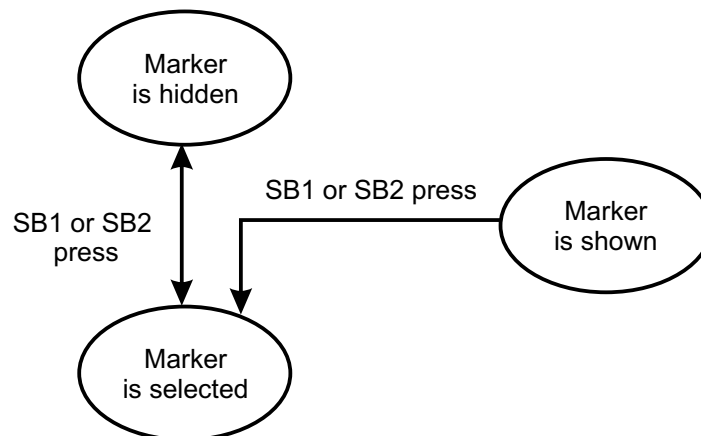

Left / Right Buttons – move selected marker to the left / right with one screen pixel increment.

NOTE: The step resolution of marker movement depends from selected X span.

Up / Down Buttons – just like in *Span control state Up* and *Down buttons* us used to change the **Y reference**.

Parameter control state:

Parameter control state allows specific **parameters** to be set before starting the **bandscan**.

Button assignments:

Left / Right Buttons – cycles through available parameters.

Up / Down Buttons – changes the value of selected parameter.

The **name** and the **value** of the selected **parameter** appears briefly over the data plot.

NOTE: Upon leaving *Parameter control* state the readout for selected **parameter** will disappear from the screen. This occurs on *OK* press or after 2 seconds timeout if no button is pressed.

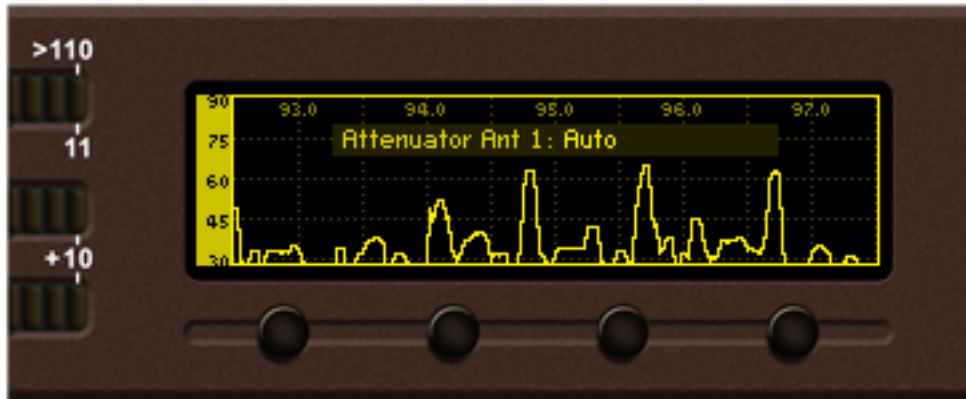

Following is the list and short description of available **parameters** from *Bandscan* page.

Bandscan : Start / Stop – Used for starting or stopping of the **bandscan process**. Setting the value of this parameter to “Start” will start the **bandscan process**. During **bandscan** the LED bargraphs are turned to stylized box-shaped progress indicator. The information for **bandscan progress** is also shown on right bottom corner of data plot.

After **bandscan** completion the value of the **Bandscan parameter** is set to “Stop” automatically.



Bandscan in progress

Running **bandscan** can be stopped by setting the value of **Bandscan parameter** to “Stop”.

Start Frequency: – set the **start frequency** of the **bandscan**.

End Frequency: – set the **end frequency** of the **bandscan**.

Step:10, 20, 50, 100 kHz – set the **step** increments for the band. Smaller **step** leads to more “fine” **bandscan** but is slower;

Pressing **SB4** in *Bandscan* page will transition to previous page.

NOTE: Leaving the page will not stop running **bandscan**. The **bandscan** will continue until it is finished or the value of **Bandscan parameter** is set to “Stop”.

FFT Page

Select *FFT icon* from *Menu page* and short press *OK button* on it. The transition to *FFT page* will be made. As name of the page shows, spectral components of the selected signal are determined on the base of Fast Fourier Transform.

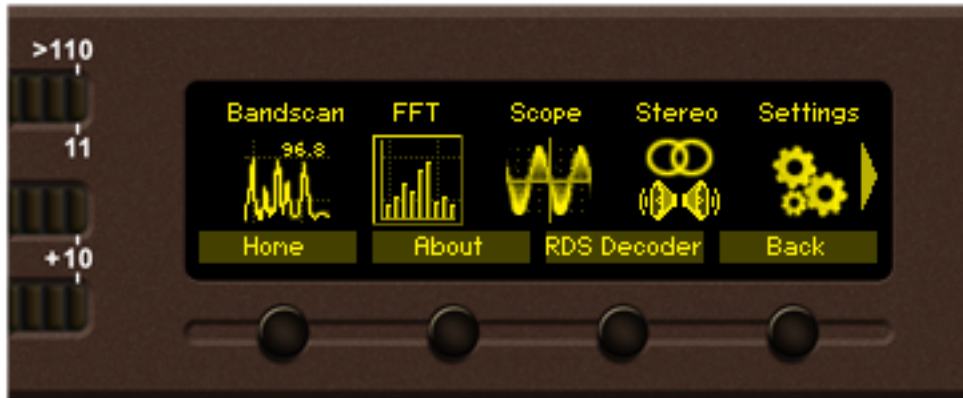

The data from last selected **FFT source signal** since DB4005 power-up will be shown on the display.

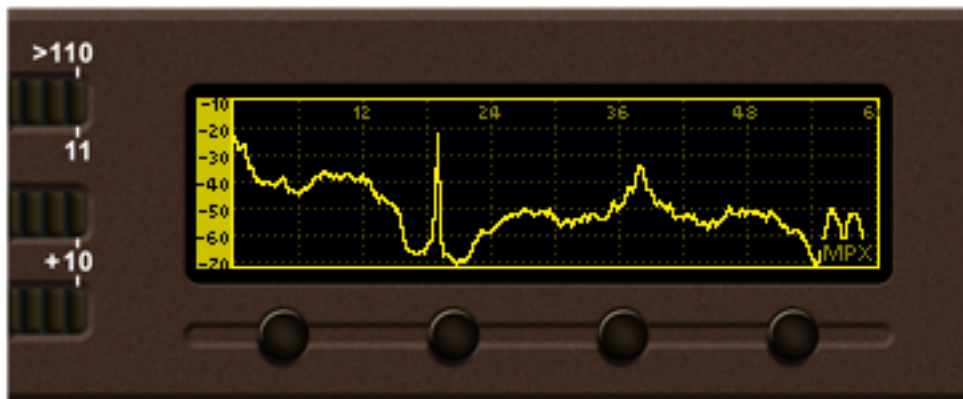

FFT with MPX selected as signal source

The control states of *FFT page* are identical to the controls states of *Bandscan page* (see [“Span control state” on page 36](#), [“Marker control state” on page 38](#), [“Parameter control state” on page 39](#)). The **X Span**, **Y Span**, **Center Frequency**, **Y Reference** and **Markers** can be changed in similar way. Each **signal source** has dedicated set of **X Span**, **Y Span**, **Center Frequency** and **Y Reference** setting.

There are several parameters available in *Parameter control state* from *FFT page*.

Source: RF – determine the source signal for FFT calculation. Four possible values are available – *RF*, *MPX*, *Left* and *Right*. The name of the selected signal source is overlaid at right bottom corner of the data plot.

RF Input: Antenna 1 – select active **antenna input** or **MPX input** of DB4005.

Window: Rectangle – sets the **Window Function** to calculate the FFT. The possible values of the parameter are: *Rectangle*, *Barlett*, *Blackman*, *Hamming*, *von Hann* and *Flat-top*. More information regarding **Window Function** utilizing can be found on <http://zone.ni.com/devzone/cda/tut/p/id/4844>;

Average: 5 – indicates **buffer numbers** taken into account in calculation and obtaining the average signal. The possible values of the parameter are: 1 (no average), 5, 10, 20, 50, Infinite

Frequency: 98.00 MHz – sets the **frequency** at which the DB4005 is tuned.

Scope Page

Select *Scope icon* from *Menu page* and short press *OK* button on it. The transition to *Scope page* will be made. **Scope mode** is used to visualize the most important signals participating in the process of demodulating and stereo decoding. This mode represents the observed signal change over time. In order to maximize the plot area, the *Header* and *Soft buttons* labels are hidden.

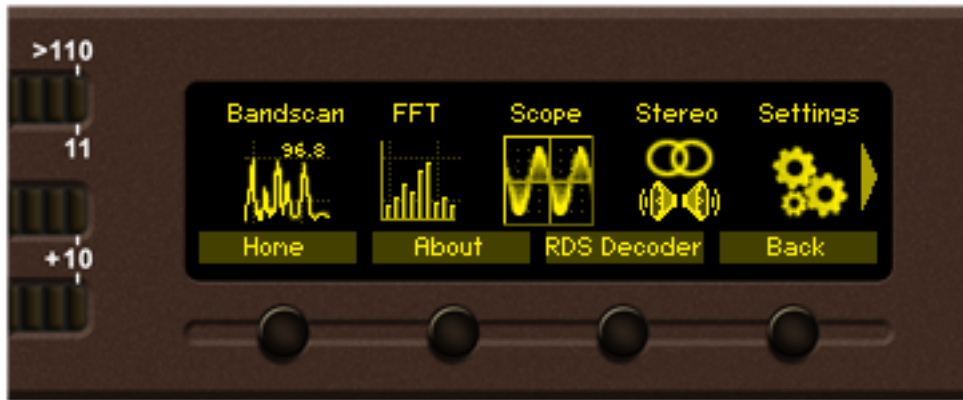

The data from last selected **Scope source signal** since DB4005 power-up will be shown on the display.

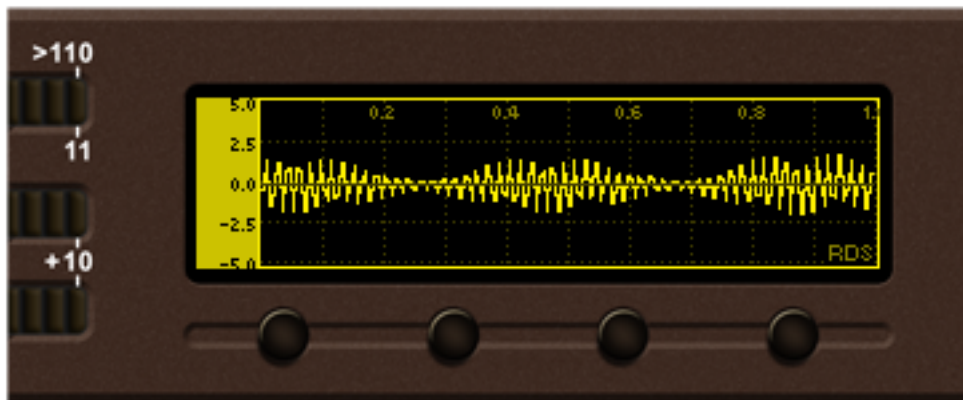

Scope with RDS selected as signal source

The display appearance and control states of *Scope page* are identical to the controls states of *Bandscan page* (see [“Span control state” on page 36](#), [“Marker control state” on page 38](#), [“Parameter control state” on page 39](#)). The **X Span**, **Y Span**, **Center Frequency**, **Y Reference** and **Markers** can be changed in similar way. Each signal source has dedicated set of **X Span**, **Y Span**, **Center Frequency** and **Y Reference** setting.

Available parameters in scope page:

Source: RF – Determine the **source signal** for scope plot. Possible sources are – *RF*, *MPX*, *Left*, *Right*, *Pilot*, *RDS*, *Sub* and *Main*. The name of the selected **signal source** is overlaid at right bottom corner of the data plot.

RF Input: Antenna 1 – Select active **antenna input** or **MPX input** of DB4005.

Frequency: 98.00 MHz – Sets the **frequency** at which the DB4005 is tuned.

Measure Stereo page

Select *Stereo* icon from *Menu* page and short press *OK* button on it. The transition to *Measure Stereo* page will be made.

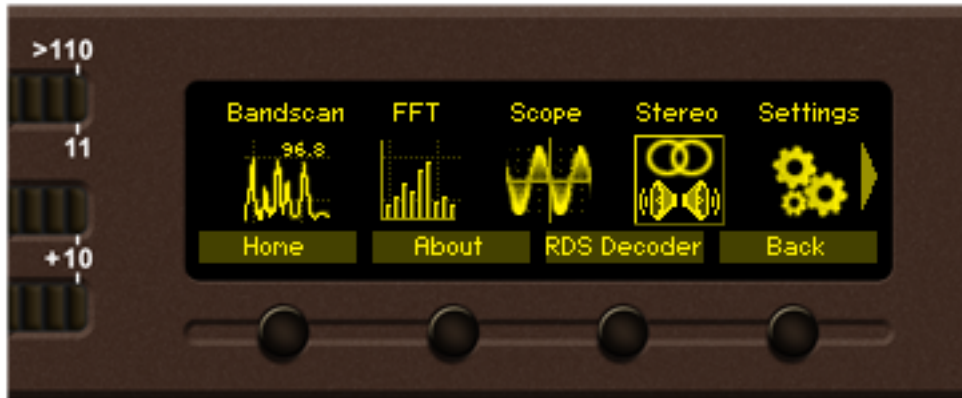

The graphical representation of the phase relations between *Left* and *Right* audio channels is illustrated above. This graphic is used to assess mono compatibility of the audio material as well as visualizing the stereo image or balance of the material. Experienced users of this type of display can easily detect the differences between mono signals, “pan-pot” stereo and true stereo signals. The audio levels for both left and right channels are given in kHz.



Button assignments:

OK – Transition to *Main menu*.

Left/Right – Sets **current frequency**.

Up/Down – Increases/decreases Phones audio level..

SBI-SB4 – Fast *Presets*.

Graphs page

Select *Graphs icon* from *Menu page* and short press *OK* button on it. The transition to *Graphs page* will be made.



Graph page represents the value deviation of measured parameters in time. The X axis of the data plot area is elapsed time in seconds. New peak value sample is added to data graph on every 125 ms (20 seconds for *MPX power*). Up to 20 seconds of measurement history is available for each parameter. The most recent moment in time is on the right side of the graph. The name and the unit for Y axis of currently measured parameter is displayed on top left corner of data plot. On the right side of the display a bargraph indicator is used to display momentary value of selected parameter. The low and high limits of measured range are also available in shaded color.



Graph history of RF level



Graph history of MPX Power – time span is in minutes

Button assignments:

OK – Transition to *Main menu page*.

Left/Right – Changes **current frequency**.

Up/Down – Changes currently displayed **parameter history**. Following parameters are available for observation:

- *RF Level* – from -10 to 110 in dB μ V;
- *Multipath level* from 0 to 50 in % (percent);
- *Total MPX deviation* from 0 to 125 in kHz;
- *MPX power* from -12 to 12 in dBr. Due to 20 second integration of *MPX power* calculation the time span for *MPX power* graph is in minutes. Up to 48 minutes of *MPX power* history is available;
- *Pilot level* from 0 to 15 in kHz;
- *RDS level* from 0 to 15 in kHz;
- *Left + Right (Main)* level from -60 to 10 in dB;
- *Left - Right (Sub)* level from -60 to 10 in dB;
- *Left audio level* from -60 to 10 in dB;
- *Right audio level* from -60 to 10 in dB;
- Loudness Momentary ITU BS.1770-4/EBU R128 , 0-70LKFS/LUFS;
- Loudness Short-term ITU BS.1770-4/EBU R128, 0-70 LKFS/LUFS;
- Loudness Long-term ITU BS.1770-4/EBU R128, 0 LKFS/LUFS, up to 120 sec intergration time;
- Stereo Blend in %;
- *Frequency offset* of the RF carrier from -50 to 50 in kHz;
- *Temperature* in the device from -10 to 90°C;

SBI-SB4 – Fast Presets.

Levels page

Select *Level icon* from *Menu page* and short press *OK* button on it. The transition to *Levels page* will be made.



Levels page shows bargraph representation of different parameters, measured by DB4005. The parameters are shown in groups by four. Each bargraph displays averaged momentary value in highlighted color number, minimum and maximum peak values. Shaded color number found on the left and right bottom edges denotes the measurement range of the parameter. The name and measurement unit of the parameter is shown above corresponding bargraph.



Group 1. This group shows RF carrier related parameters

RF, dBµV
-10 76 110 *RF level in dBµV at the input. The attenuator position is taken into account in level calculation;*

Frequency Offset, kHz
-50 0.14 50 *Frequency offset of the RF carrier in kHz. With this parameter the misalignment between the modulation and demodulation frequency can be measured. As the misalignment is expected to be small, a large offset indicates disturbance (for example adjacent channel breakthrough). Frequency offset is measured with better accuracy if there is no modulation of the carrier. The usable range depends of selected IF filter bandwidth. For best result set IF filter bandwidth to 153 kHz (manual).*



Level of *multipath* reception in percent. The *multipath* detector measures amplitude fluctuations of the signal. An FM signal is broadcast with a fixed level. Therefore level fluctuations indicate degraded signal quality. At *multipath* conditions large level fluctuations can be measured. For best measurement accuracy try to find reception point with lowest *multipath* level.



Shows currently selected *IF filter bandwidth*.



Group 2. This group shows Stereo multiplex related parameters



These two bargraphs shows the *deviation* from *positive* and *negative* component of *MPX signal*. In wideband FM, used in wireless broadcasting, the instantaneous frequency varies above and below the frequency of the carrier with no modulation. When the instantaneous input wave has positive polarity, the carrier frequency shifts in one direction; when the instantaneous input wave has negative polarity, the carrier frequency shifts in the opposite direction. At every instant in time, the extent of carrier-frequency shift (the deviation) is directly proportional to the extent to which the signal amplitude is positive or negative.

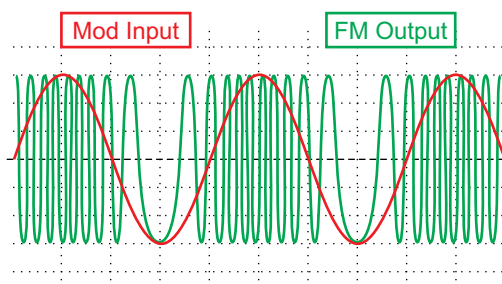

Shows the deviation caused by *Pilot* tone injection. As good practice the pilot deviation should be about 10% from total deviation of the RF carrier.

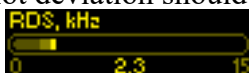

Same for RDS signal.



Shows the average program loudness measurements as defined by ITU BS.1770-4 and EBU R128 recommendations. The following measurements are available:

Momentary – average program loudness measured over a 0.4s sliding time window, not gated;

Short-term – average program loudness measured over a 3s sliding time window, not gated;

Long-term – average program loudness measured over a variable sliding time window, gated as described in ITU BS.1770-4. The time window can be varied between 10s and 120s.



Group 3. This group shows Audio related levels



Group 4. This group shows reception quality related levels



Ultrasonic Noise bargraph (lower is better). To give an indication about the *Ultrasonic Noise* the amplitude of the high frequency content of the *MPX signal* is measured. This is measured in the bandwidth of approximately 80 kHz up to 150 kHz.



Stereo Blend bargraph (higher is better). In stereo signals, the difference (L-R) component of the *MPX signal* is more susceptible to disturbances than the sum (L+R) signal. Therefore, the separation of the left and right audio channels can be reduced in order to reduce the audibility of the disturbance. This reduction of channel separation is called “*stereo blending*”. The level of stereo blending is depends on the following input signals: *Signal Level*, *Multipath*, *Ultrasonic Noise* and *Pilot tone deviation*.



High Cut bargraph. Most of the effect of disturbances is present in the higher audio frequencies. Therefore, a means of reducing the effect of disturbances is to filter the higher frequencies. This reduction of audio bandwidth is called “high cut”. The level of applied *High Cut* depends on the following input signals: *Signal Level*, *Multipath*, *Ultrasonic Noise*.

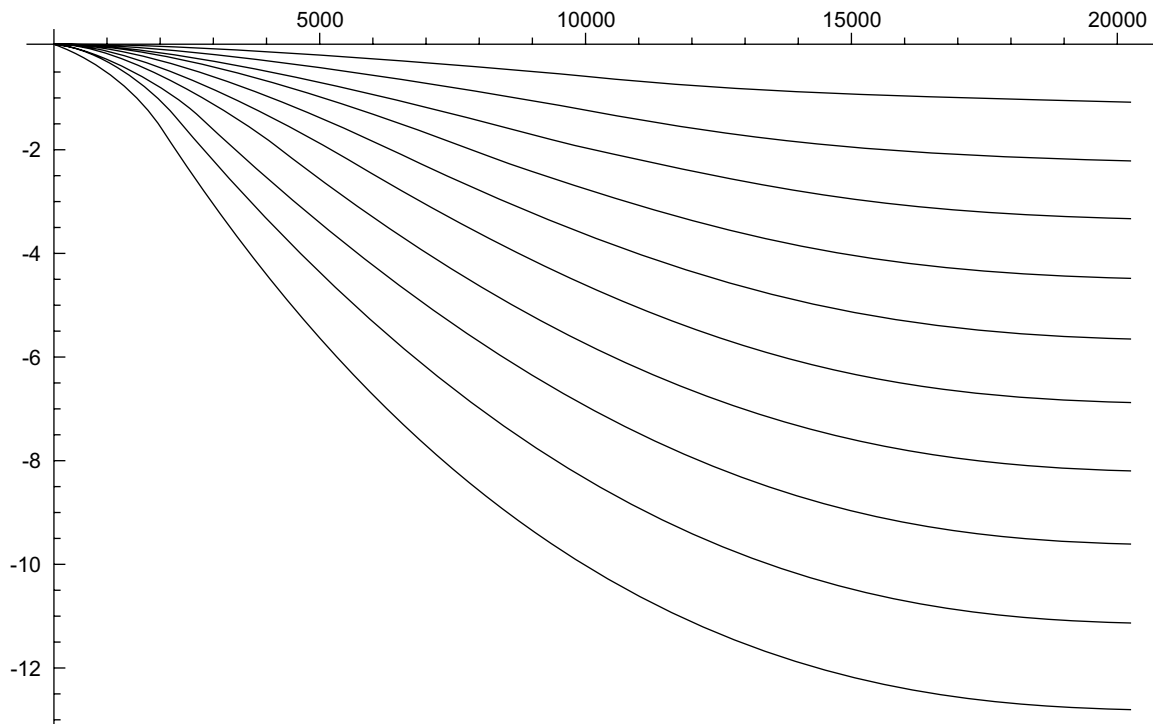

Response of the FM High Cut function for several reduction values



Soft Mute bargraph (lower is better). If disturbances are present in the received signal, the perceived effect can be reduced by attenuating the audio signal. This reduction of audio volume is called “soft mute”. *Soft Mute* depends on the following input signals: *Signal Level*, *Multipath* and *Ultrasonic Noise*.

Button assignments:

OK – Transition to *Main menu page*.

Left/Right – Changes **current frequency**.

Up/Down – Changes currently displayed bargraph group 1-4.

SB1-SB4 – Fast *Presets*.

RDS decoder page

Short press *SB3* from *Menu* page. The transition to *RDS decoder* page will be made.



RDS page main view



RDS AF list view



RDS Statistics view

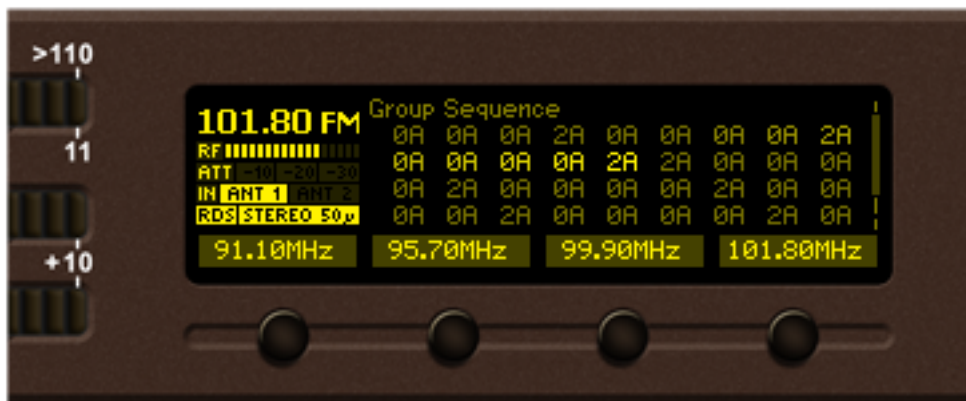

RDS Group Sequence view



RDS Raw Data view

Button assignments:

OK – Transition to *Main menu* page.

Left/Right – Changes **current frequency**.

Up/Down – Changes currently displayed *RDS page view*.

SB1-SB4 – Fast *Presets*.

Settings page

Select *Settings icon* from *Menu page* and short press *OK button* on it. The transition to *Settings page* will be made.



The device settings are organized as hierarchical tree menu (*Settings menu*). Similar parameters are grouped in sections (branches). The overall view of the *Settings menu* is shown on the figure below.





“Tuner” section (branch) from the root Settings menu is selected



“Frequency” parameter from “Tuner” branch is selected

There is several areas in the *Settings menu* screen:

 – *Settings menu title* – shown the path to currently selected menu item. Note that parameter name has to be considered in the context of settings menu title. For example *Settings>Tuner - Frequency* is different from *Settings>Logger>Channel 1 - Frequency*.

 – *Navigation area* – the selection of certain branches / parameters is made here. The selected item is drawn in highlighted color. The names of the branches or parameters are listed on the right side of the navigation area. The value of the parameter is shown on the right – against the parameter name. Since branches have no values associated with them the tree dots are shown instead. This indicates a sublevel branch or parameter.

Button assignments:

OK – Acts differently depending on current selection. If selection is:

- Menu branch – the transition to selected branch is made and the branch items are listed in navigation area;
- Menu parameter – the value of that parameter is highlighted and edit mode is entered;
- Menu complex parameter (such as *Alarm*) – the parameter editor is shown and edit mode is activated;

Up/Down – If edit mode is active – changes the value of the selected parameter. Otherwise will move selection in corresponding direction up/down.

Left/Right – Changes selection within parameter value in edit mode. See examples below.

SB4 – Back one level or cancel menu mode.

There is several parameter types available in DB4005. The way of editing depends of that type. Following is description of parameter types. Every parameter has several properties, change step, unit, default value, permitted range for its value and so on.

Numerical parameter (INT). Represents numerical value.

Example:  The value of the **frequency** can be changed in 887.1-108 MHz (CCIR), 65-74 MHz (OIRT), 76-95 MHz (Japan) range with step of 10, 20, 50 or 100 kHz;

Button assignments for **INT** in edit mode:

OK – Accept the value and exits edit mode.

Up/Down – Changes the value of the parameter with one step increment/decrement. The value always stays in permitted parameter range.

SB4 – Discards the value and cancels edit mode.

Enumerated parameter (ENUM). Represent selection of one value from set of predefined enumerated values.

Example:  The value can be changed between “Auto”, “OFF”, “-10dB”, “-20dB” and “-30dB” position.

Button assignments for **ENUM** in edit mode:

OK – Accept the value and exits edit mode.

Up/Down – Cycles through possible value positions. The value always stays in permitted parameter range.

SB4 – Discards the value and cancels edit mode.

IP address (IP). Represents IPv4 address.

Example: **Primary DNS 192.168.001.001** , **Network Mask 255.255.255.000**

Button assignments for **IP** in edit mode:

OK – Accept the value and exits edit mode.

Up/Down – Cycles through possible values for selected (highlighted background) segment of *IP address*. The value always stays in permitted parameter range.

Left/Right – Selects previous/next segment from the *IP address*.

SB4 – Discards altered value and cancels edit mode.

IP port (PORT). Represents IP port.

Example: **Manager Port 162**

Button assignments for *IP port* in edit mode:

See *IP address* description.

String (STR). Represents string.

Example: **User Name user**

Button assignments for **STR** in edit mode:

- OK – Accept the value and exits edit mode. Note that certain *String*, like **e-mail addresses**, are validated prior acceptance. If validation fails the message box is displayed and edit mode is not left after message box confirmation. For example:



OK press



OK press



- Up/Down – Cycles through possible values for selected (highlighted background) *string character*. There is certain limitation in permitted charset depending from *string* context. For example for *phone number string* only “1234567890+” and white space characters are available.
- Left/Right – Selects previous/next character from the *string*. If Right button is pressed with the last character selected the new space character is added automatically at the end of the *string*. **User Name user|**. On Left button press the trailing spaces are removed automatically.
- *SB2* – Inserts white space before selected character.
User Name us| – before *SB2* press;
User Name us|er – after *SB2* press;
- *SB3* – Deletes selected character.
User Name us| – before *SB3* press;
User Name us – after *SB3* press.
- *SB4* – Discards altered value and cancels edit mode.

Date (DATE). Represent date information.

Example: **Date 15-Jun-2012**

Button assignments for **DATE** in edit mode:

OK – Accept the value and exits edit mode.

Up/Down – Cycles through possible values for selected (highlighted background) segment of parameter value. The value always stays in permitted parameter range.

Left/Right – Selects previous/next segment from the parameter value.

SB4 – Discards altered value and cancels edit mode.

Time (TIME). Represent time information.

Example: **Time 02:00:00**

Button assignments for **TIME** in edit mode:

See *DATE* description.

Timer (TIMER). Represents relative time interval.

Example: **Screen Saver 2 min**

Button assignments for **TIMER** in edit mode:

OK – Accept the value and exits edit mode.

Up/Down – Increments/decrements value with one step. The unit of the value changes automatically from seconds to minutes and vice-versa.

SB4 – Discards altered value and cancels edit mode.

How to change the tuning range

Settings > Device > Region



DB4005's tuning range is user selectable, 87.1-108 MHz (CCIR), 65-74 MHz (OIRT), 76-95 MHz (Japan). Changing/selecting the Region setting, will modify all tuner frequencies so that they could be within the FM band limits of the region chosen. This includes all Presets and Logger Channel frequencies.

Alarm (ALARM). Alarm is special complex parameter with its own editor dialog. Each *alarm* parameter are composed from several sub-parameters. These are:

- **Low threshold.** This is lower alarm limit for measured signal. If the value stays below this limit for certain time “low alarm” event will be generated.
- **High threshold.** This is higher alarm limit for measured signal. If the value stays above this limit for certain time “high alarm” event will be generated.
- **Trigger time.** Time to wait before “low alarm” or “high alarm” event is generated.
- **Release time.** Time to wait before “idle alarm” event is generated.
- Set of **notification channels.** Denotes the way the user is notified for the alarm event. Possible channels are: **SMS** (with GSM modem option), **E-mail**, **SMNP** and **GPO**.

Example:

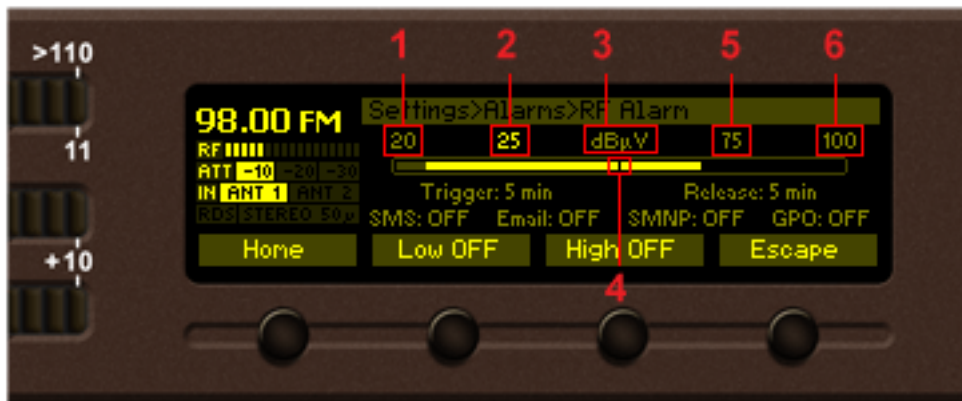

Content of alarm editor dialog with *RF Alarm* shown. The bargraph shows whole signal range of the *alarm*. The highlighted area denotes permitted signal region. If current signal value (pos. 4) falls in this region no alarm event will be generated. The basic elements are:

1. Lower limit of the alarm range.
2. Low threshold value.
3. Value unit.
4. Current value of the signal.
5. High threshold.
6. Higher limit of the alarm range.

Button assignments for **ALARM** in edit dialog:

OK – Accept the value and exits edit dialog.

Up/Down – Changes the value of selected (highlighted) sub-parameter. The value always stays in permitted parameter range. Low threshold value cannot exceed the high threshold value and vice-versa.

Left/Right – Selects previous/next sub-parameter of the *alarm*.

SB2 – Toggles ON/OFF low alarm event generation.

SB3 – Toggles ON/OFF high alarm event generation.

SB4 – Discards altered sub-parameter values and cancels edit mode.

Channel (CHANNEL). This is complex parameters which combines several sub-parameters together. (CHANNEL) represents the settings for one *logger channel*:

- **Name** – channel name for convenience (STR).
- **Frequency** – *channel* frequency (INT).
- **Active** – enables/disables this *channel* (ENUM).
- **Acquisition time** – this long logger will stay and measure on that *channel* (TIMER).
- **RF Alarm** – alarm settings for *RF level* (ALARM).
- **MPX Alarm** – alarm settings for *MPX total modulation* (ALARM).
- **MPX Power Alarm** – alarm settings for *MPX power* (ALARM).
- **Pilot Alarm** – alarm settings for *Pilot tone deviation* (ALARM).
- **RDS Power Alarm** – alarm settings for *RDS subcarrier deviation* (ALARM).
- **RDS Group Alarm** – alarm settings for *RDS group presence* (ALARM).
- **Left Alarm** – alarm settings for *Left audio signal level* (ALARM).
- **Right Alarm** – alarm settings for *Right audio signal level* (ALARM).

Example:



Channel 1 settings

HOW TO START A LOGGER CAMPAIGN USING THE FRONT PANEL MENU?

In order to set up a campaign via the front panel menu, the following steps should be completed:

1. Press the [OK] button to enter the *Main menu*> *Settings* and again press [OK];
2. Then select *Logger*> *Channel I*;
3. Specify name of the Channel, frequency and for 'Active' - select Antenna 1 or MPX Input; to exclude a station from the campaign the "Disable" button should be selected;
4. Change the Acquisition time as per your preferences. We recommend setting it to 10 seconds;
5. Change the alarm parameters as per your preferences;
6. Steps from 2 to 4 should be applied for each of the channels to be monitored. Once all PI Channels are set you can proceed to the last step
7. Go to *Settings*> *Logger*> *Logger Mode* and as a value set 10 seconds. In order for a campaign to be commenced the device should be inactive for the specified time.

NOTE: The front panel inactivity time should expire prior the Logger mode countdown to begin.

WEB Interface

DB4005 can be controlled through the built-in web server. A standard web browser can be used to monitor the status of the device or to make some adjustments.

There are two options for access to the WEB Interface of DB4005. The first one is through manual identification of the IP address of the device, and the second one is through the Network discovery option (For Windows 7 and above users only).

MANUAL IP ADDRESS IDENTIFICATION

Connect the device to a local network or to the Internet by the applied LAN cable. Through the Front panel navigational menu, pressing the “OK” button you will be enabled to enter the device main menu.

Using the “Right” navigational button find the “Status” section, located at the end of the Menu.



Press the “OK” Button to enter the “Status” section. Via the Front panel navigational menu press the “DOWN” button.



This operation will visualize the screen containing information about the IP Address of the device.

Open a new WEB Browser and enter the device IP address in the address field, then press “Enter”.

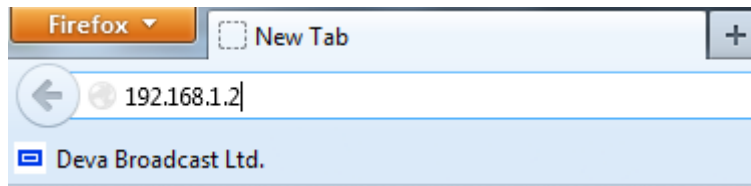

NOTE: Due to the inability of some WEB Browsers to read the IP address format displayed on the screen of the device, the numbers included in the IP Address must be written without the leading zeros. For example: 192.168.020.095 must be written as 192.168.20.95

A window that requires username and password will appear.

NETWORK DISCOVERY

This is a network setting that defines whether your computer can see (find) other computers and devices on the network and whether other computers on the network can see your computer. By default, Windows Firewall blocks network discovery but you can enable it.

1. Open Advanced sharing settings by clicking the Start button, and then “Control Panel”. In the search box, type “network”, click “Network and Sharing Center”, and then, in the left pane click “Change advanced sharing settings”;
2. Select your current network profile;
3. Click Turn on network discovery, and then click save changes.

NOTE: If you’re prompted for an administrator password or confirmation, type the password, provide confirmation or contact your system administrator.

If you have already enabled this function on your computer, DB4005 will be automatically added to the Device list section. The device will be ready for usage and no additional adjustments will be required except for user name and password.

ACCESS

The DB4005 provides you with a protected access to the device settings. You can choose between two types of log in:

1. **As an Administrator** – which will give you full control over the settings (username: admin, password: pass);
2. **As an User** – this type of log-in will allow you to monitor the device and to choose different stations without applying settings (username: user, password: pass).

In order to make the necessary adjustments to the device, please log in as Administrator.

MAIN SCREEN

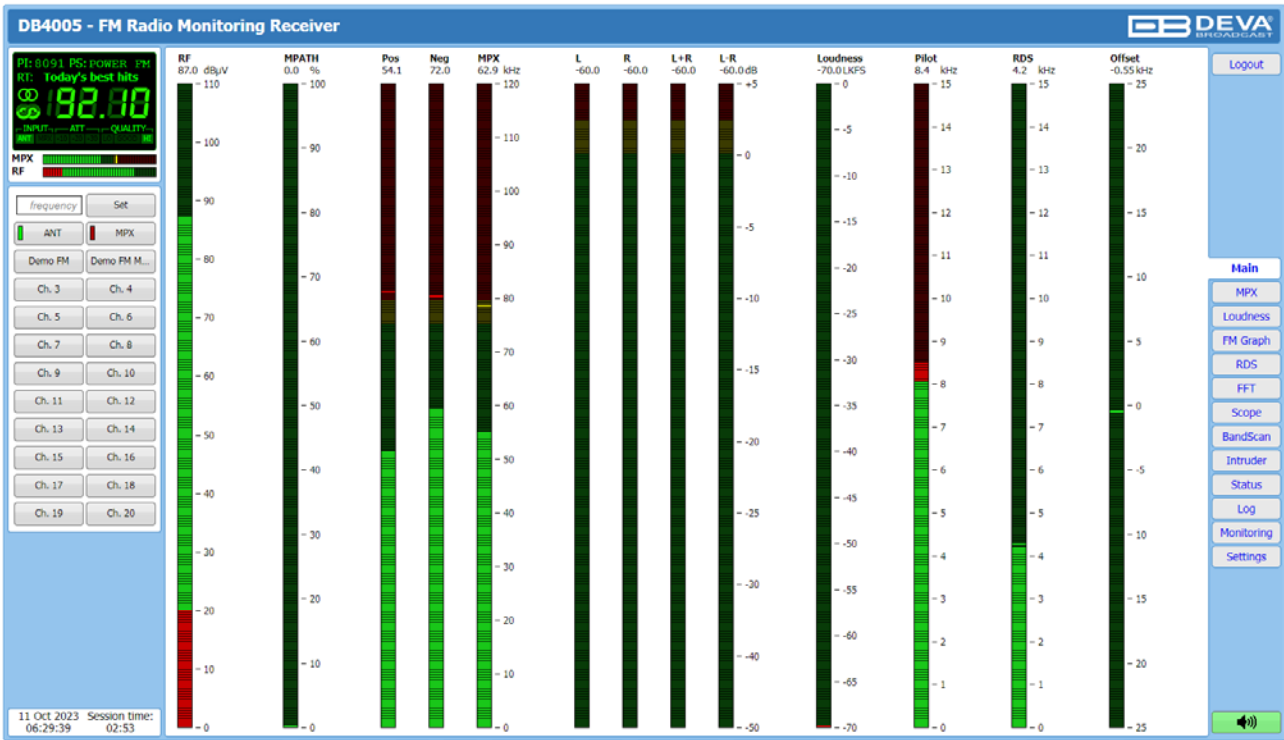

The Main Screen of the WEB Interface shows all the mandatory parameters represented as LED readings.

You can choose between antenna or MPX input and easily select the preferred audio frequency by using the selection buttons, placed on the left part of the screen. All station presets are defined by the user.

NOTE: The first 20 channels set in the Logger tab will appear as station presets on the left section of the WEB interface.

RDS/RBDS SCREEN

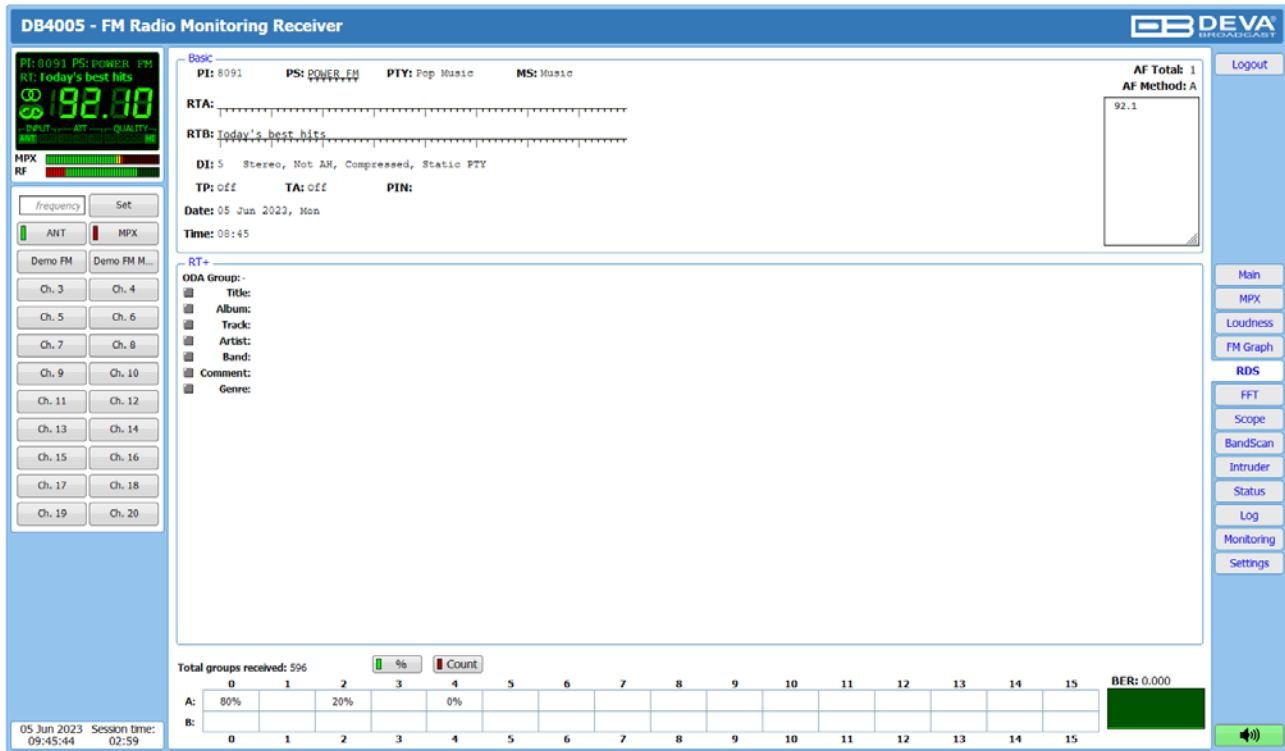

All basic elements of the RDS/RBDS are displayed on the screen – PI, PS, RT, TA/TP, etc. The Alternative frequencies are also available, represented in a list. DB4005 supports the two most used ODA Applications. At your disposal are the Radio Text Plus and the Traffic Message Channel.

If your Radio station has RT+ or TMC – DB4005 will display the information from those ODA Groups.

Total groups Indicator – all received groups are systematized into a table, representing the percentage/quantity of the groups in the received RDS/RBDS signal. The user selects how the “Total groups received” data should be represented: as Percents (%) or as Count, by selecting the corresponding button.

A BER Indicator with graphics is placed at the right bottom part of the screen, showing 60 sec. history of the BER quantities.

NOTE: The bit error rate or bit error ratio (BER) is the number of bit errors, divided by the total number of transferred bits during the observed time interval. Result closer or equal to 0 indicates that no bit errors are detected and vice versa - result closer or equal to 1 indicates that the received transferred bits are only errors.

FM GRAPH SCREEN

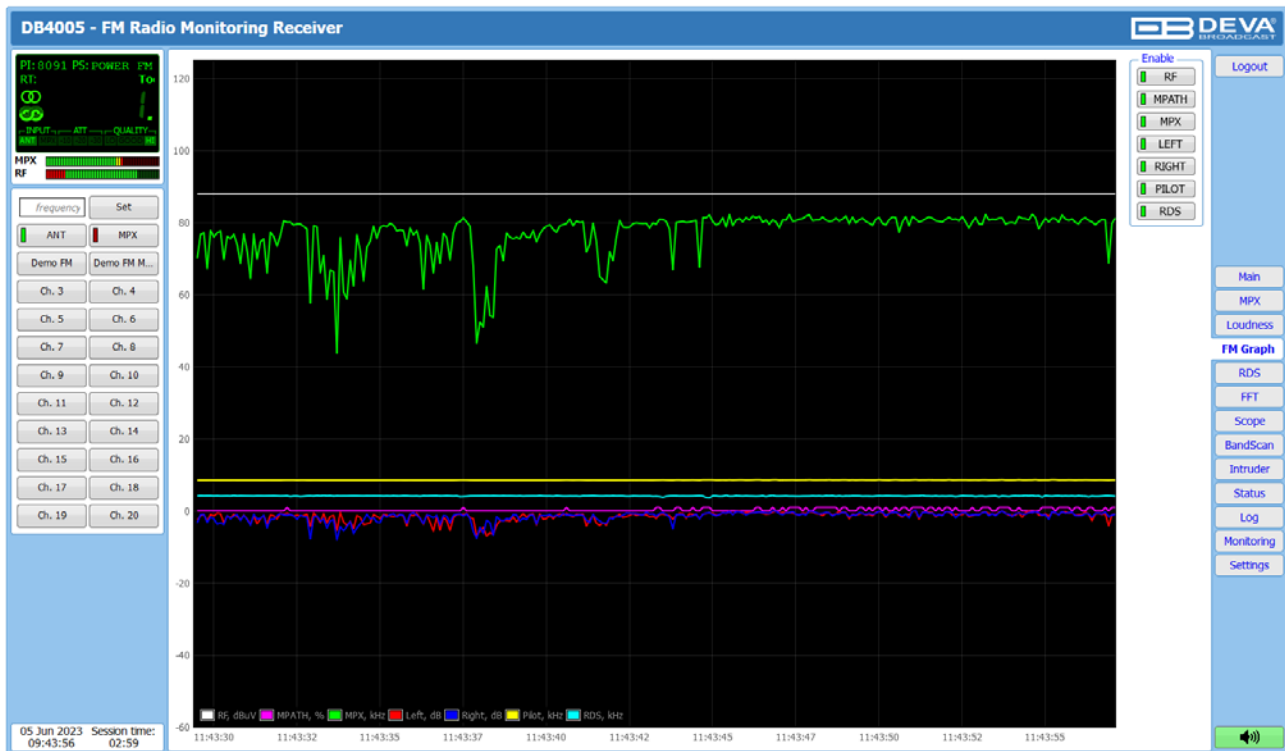

This screen represents all mandatory signals over the time span of 1 minute. All parameters have own color representation and measurement units, visible below the graph.

According to your needs, the signals listed on the right part of the dialog window, can be visible or hidden. Click on the corresponding button in order for a parameter to be displayed/hidden.

The radio frequency to be observed could be easily set by using the preset buttons, placed on the left part of the screen.

MPX SCREEN

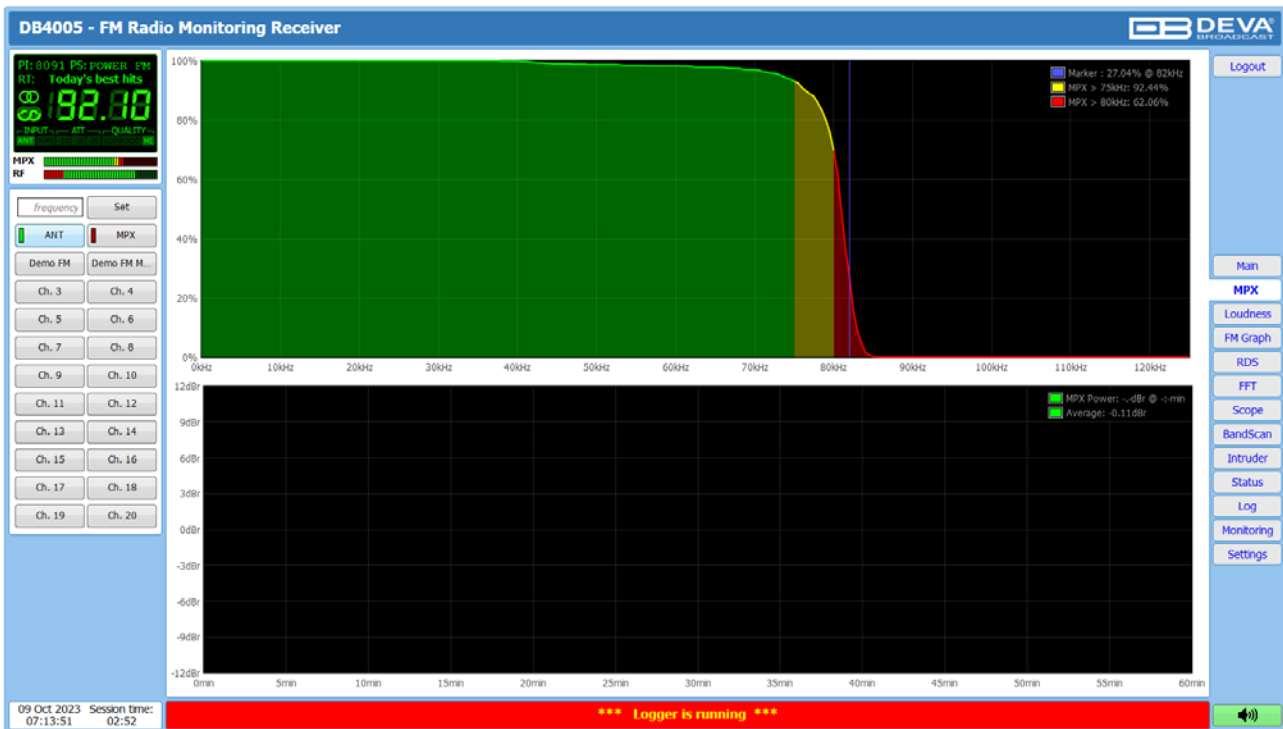

The graphic represents the MPX Deviation overshoot (in percentage) over time. Standard overshoot is measured at 75 kHz and is indicated in the top right corner of the graphic.

The graphic below represents MPX Power over the time span of 60 min. This signal has an initial integration time of 1 min, after that a new sample will be available every 20 seconds.

The radio frequency to be observed could be easily set by using the preset buttons, placed on the left part of the screen.

LOUDNESS

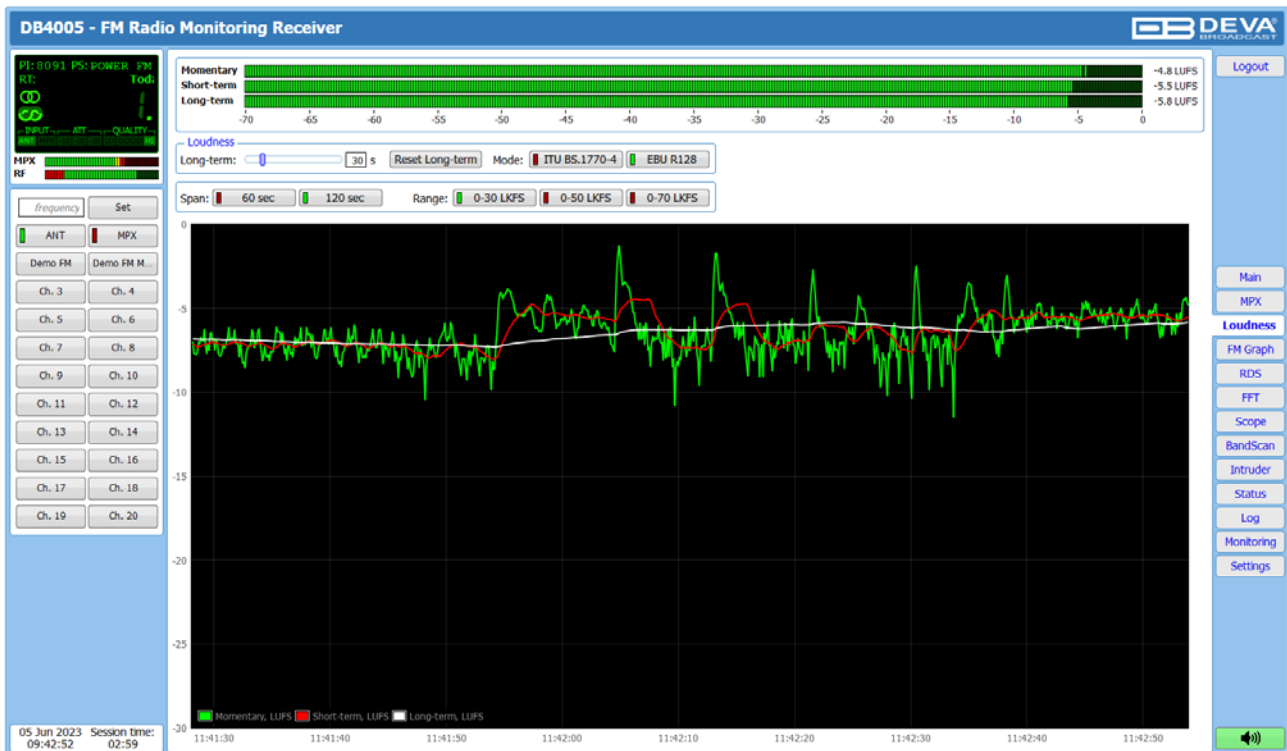

The average program loudness measurements as defined by the ITU BS.1770-4 and EBU R128 recommendations are represented at this page. The following measurements are available:

- Momentary** – average program loudness measured over a 0.4 seconds sliding time window, not gated;
- Short-term** – average program loudness measured over a 3 seconds sliding time window, not gated;
- Long-term** – average program loudness measured over a variable sliding time window, gated as described in ITU BS.1770-4. The time window can be varied between 10 seconds and 120 seconds.

The page offers all the above measurements in two display forms – high refresh rate bar graphs for displaying current values and a time graph for extended visualization over time. The user can modify the processing and appearance of the measurement using the following settings:

- Long-term** – allows the user to select the length of the Long-term loudness measurement sliding time window. The time-based sliding window could be set with length from 10 to 120 seconds;
- [Reset Long-term] – Resets the Long-term measurement;
- Mode** – allows the user to select/change between [ITU BS.1770-4] and [EBU R128] mode;
- Span** – sets the time graph span. Options of 60 sec and 120 sec are available;
- Range** – the option buttons allow the user to set the preferred time graph measurement range.

SPECTRUM SCREEN

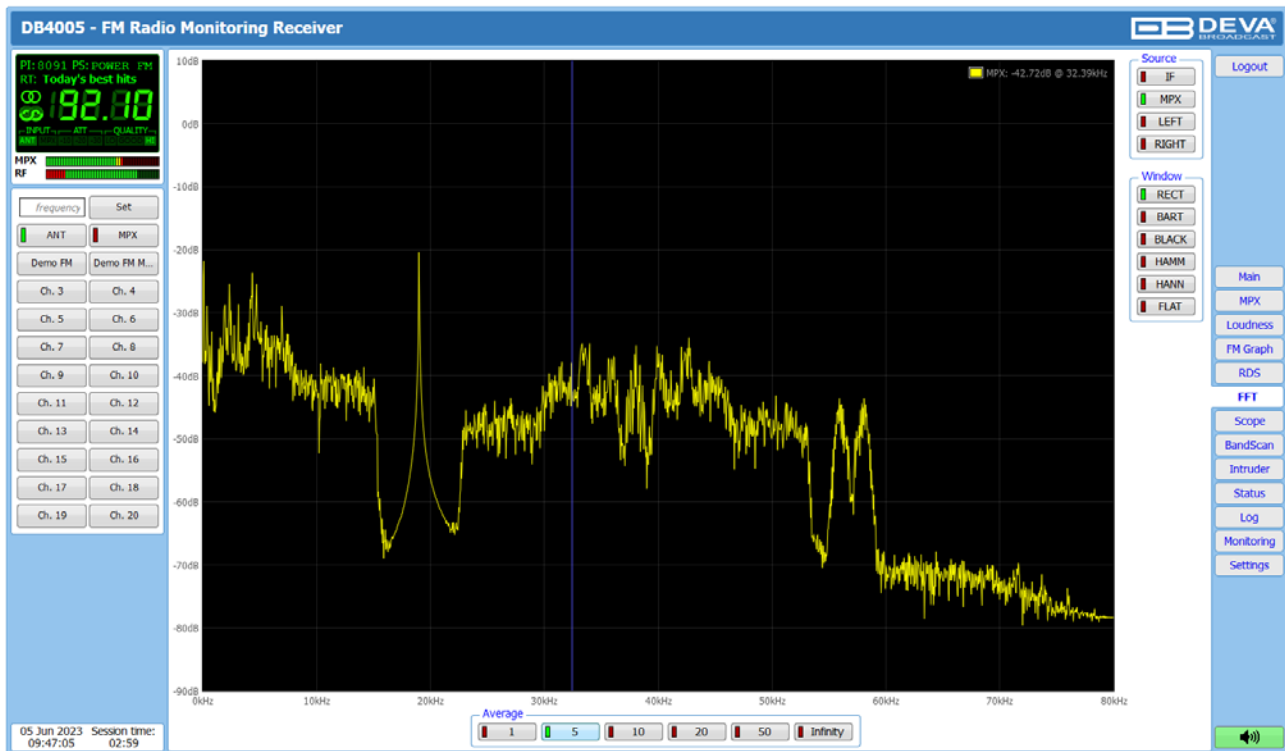

The spectrum analyzer tab is a very useful feature: It is an IF, MPX and Audio spectrum display. Initially it shows the IF from -250 to 250kHz, so that the readings of the currently selected source to be clearly visible.

The signal source to be calculated and visualized is chosen from the Source section, placed on the right part of the screen. Spectral components of the selected signal are determined on the basis of Fast Fourier Transform.

The window function can be selected through the relevant menu via the interactive buttons. The available windows and their features are given below. This table can be used to help you choose the best windowing function for each application.

Window	Best type for these Signal Types	Frequency Resolution	Spectral Leakage	Amplitude Accuracy
Rectangle	Transient & Synchronous Sampling	Best	Poor	Poor
Barlett	Random	Good	Fair	Fair
Blackman	Random or mixed	Poor	Best	Good
Hamming	Random	Good	Fair	Fair
Von Hann	Random	Good	Good	Fair
Flat-top	Sinusoids	Poor	Good	Best

The visualized Spectrum waveform is equivalent of the average value of several measurements which are defined in section “Average”.

The radio frequency to be observed could be easily set by using the preset buttons, placed on the left part of the screen.

SCOPE SCREEN

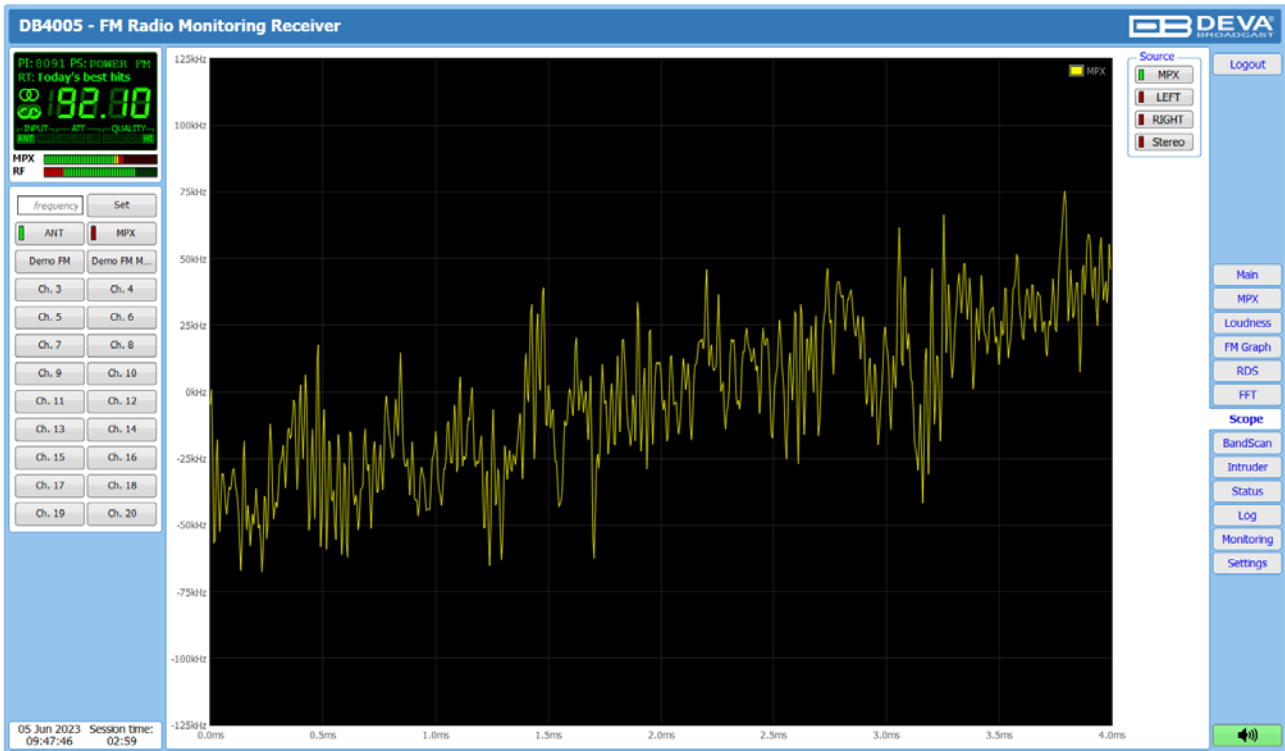

Scope screen represents the signals participating in the process of demodulating and stereo decoding over time. In order for the signal source to be changed, the corresponding button on the right-side of the graph should be pressed.

BANDSCAN SCREEN

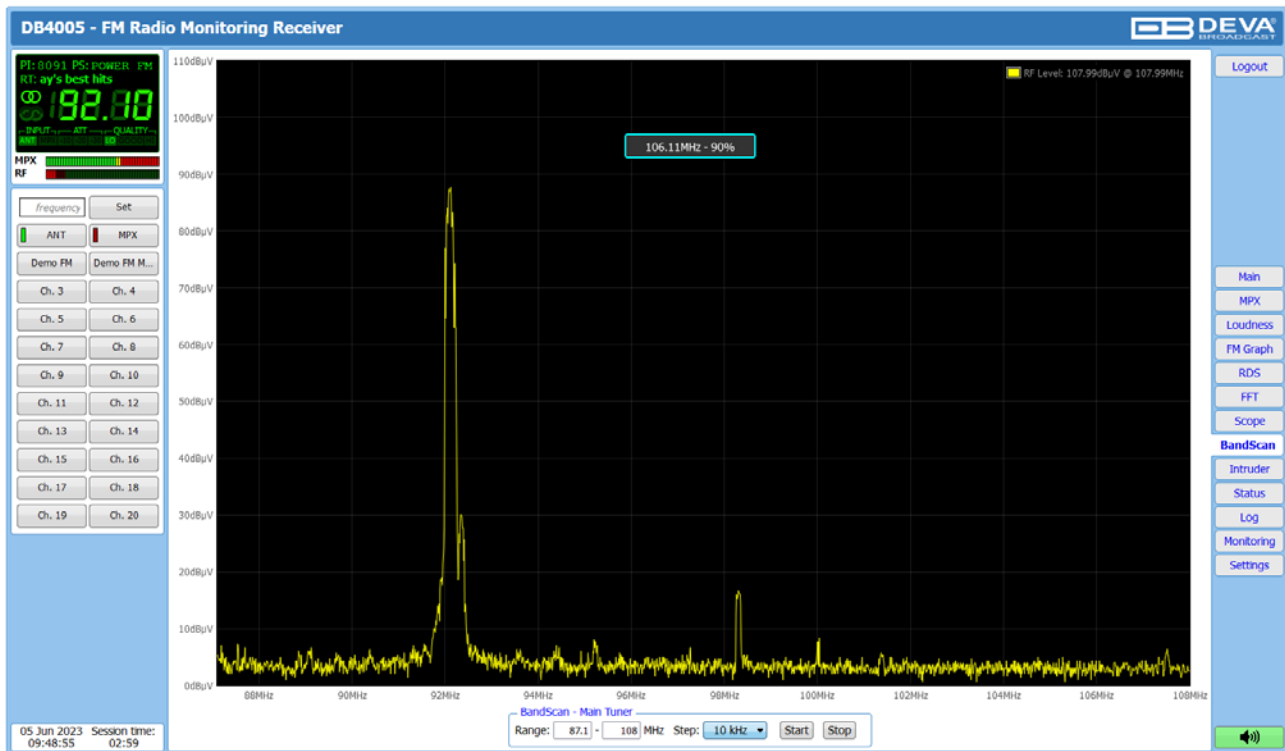

This Screen evaluates FM broadcast band congestion by sweeping the tuner across the FM band, logging every carrier and generating a spectrum display of carrier level vs. frequency.

The Bandscan application utilizes four different types of Bandscan, depending on the preferred signal frequency step. The bandscanning mode could be customized by setting low and high frequency limits of the scan. Once you have set the frequency step and low/high frequencies, the start button should be pressed in order for the Bandscan process to be initiated. The current scan could be stopped at any time by pressing the Stop button.

To evaluate the RF level of the specified frequency, move the vertical marker along the horizontal scale. The Values at the cross-point will be shown at the top right corner of the graph.

STATUS SCREEN

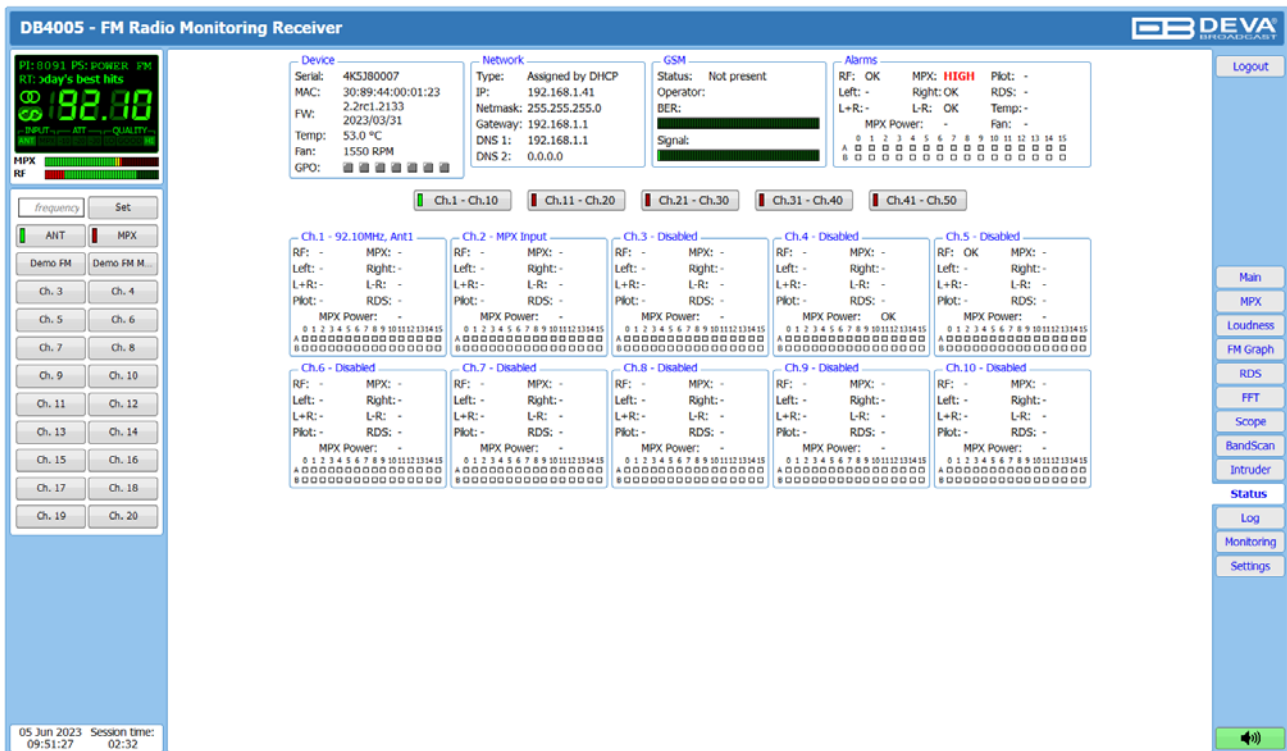

The status tab shows the alarm status of each parameter of the preset frequencies, along with the basic device and network status (IP address, MAC, etc.).

The Channel parameters (RF, MPX, Pilot etc.) have several conditions:

- In range - green OK;
- Out of range - red LO or HI;
- Signal monitoring is not enabled - n/a.

The status of the RDS/RBDS Groups Alarm is displayed on the bottom of the channels' section:

- Green - RDS/RBDS Group is received;
- Red - RDS/RBDS Group is not received and an alarm has been triggered;
- White (blank) - RDS/RBDS Group is not received and no alarm has been triggered.

LOG SCREEN

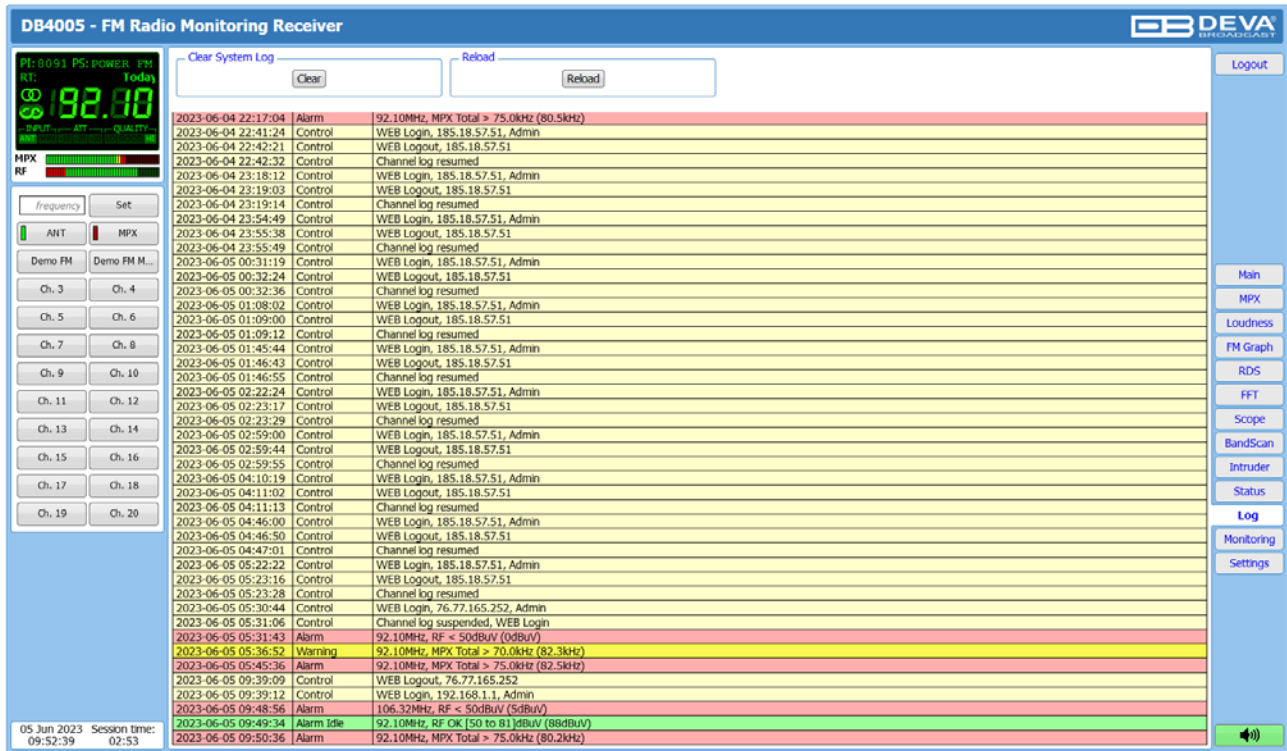

Date/Time	Event Type	Details
2023-06-04 22:17:04	Alarm	92.10MHz, MPX Total > 75.0kHz (80.5kHz)
2023-06-04 22:41:24	Control	WEB Login, 185.18.57.51, Admin
2023-06-04 22:42:21	Control	WEB Logout, 185.18.57.51
2023-06-04 22:42:32	Control	Channel log resumed
2023-06-04 23:18:12	Control	WEB Login, 185.18.57.51, Admin
2023-06-04 23:19:03	Control	WEB Logout, 185.18.57.51
2023-06-04 23:19:14	Control	Channel log resumed
2023-06-04 23:54:49	Control	WEB Login, 185.18.57.51, Admin
2023-06-04 23:55:38	Control	WEB Logout, 185.18.57.51
2023-06-04 23:55:49	Control	Channel log resumed
2023-06-05 00:31:19	Control	WEB Login, 185.18.57.51, Admin
2023-06-05 00:32:24	Control	WEB Logout, 185.18.57.51
2023-06-05 00:32:36	Control	Channel log resumed
2023-06-05 01:08:02	Control	WEB Login, 185.18.57.51, Admin
2023-06-05 01:09:00	Control	WEB Logout, 185.18.57.51
2023-06-05 01:09:12	Control	Channel log resumed
2023-06-05 01:45:44	Control	WEB Login, 185.18.57.51, Admin
2023-06-05 01:46:43	Control	WEB Logout, 185.18.57.51
2023-06-05 01:46:55	Control	Channel log resumed
2023-06-05 02:22:24	Control	WEB Login, 185.18.57.51, Admin
2023-06-05 02:23:17	Control	WEB Logout, 185.18.57.51
2023-06-05 02:23:29	Control	Channel log resumed
2023-06-05 02:59:00	Control	WEB Login, 185.18.57.51, Admin
2023-06-05 02:59:44	Control	WEB Logout, 185.18.57.51
2023-06-05 02:59:55	Control	Channel log resumed
2023-06-05 04:10:19	Control	WEB Login, 185.18.57.51, Admin
2023-06-05 04:11:02	Control	WEB Logout, 185.18.57.51
2023-06-05 04:11:13	Control	Channel log resumed
2023-06-05 04:46:00	Control	WEB Login, 185.18.57.51, Admin
2023-06-05 04:46:50	Control	WEB Logout, 185.18.57.51
2023-06-05 04:47:01	Control	Channel log resumed
2023-06-05 05:22:22	Control	WEB Login, 185.18.57.51, Admin
2023-06-05 05:23:16	Control	WEB Logout, 185.18.57.51
2023-06-05 05:23:28	Control	Channel log resumed
2023-06-05 05:30:44	Control	WEB Login, 76.77.165.252, Admin
2023-06-05 05:31:06	Control	Channel log suspended, WEB Login
2023-06-05 05:31:43	Alarm	92.10MHz, RF < 50dBuV (0dBuV)
2023-06-05 05:36:52	Warning	92.10MHz, MPX Total > 70.0kHz (82.3kHz)
2023-06-05 05:45:36	Alarm	92.10MHz, MPX Total > 75.0kHz (82.5kHz)
2023-06-05 09:39:09	Control	WEB Logout, 76.77.165.252
2023-06-05 09:39:12	Control	WEB Login, 192.168.1.1, Admin
2023-06-05 09:48:56	Alarm	106.32MHz, RF < 50dBuV (5dBuV)
2023-06-05 09:49:34	Alarm Title	92.10MHz, RF OK [50 to 81]dBuV (88dBuV)
2023-06-05 09:50:36	Alarm	92.10MHz, MPX Total > 75.0kHz (80.2kHz)

Here are listed all the Device System Events. The local measurements and logs are saved in the internal device memory. All log files can be downloaded via the built-in FTP server.

For information on how the connection between the DB4005 and an FTP Client should be configured, please [refer to "Download files via FTP" on page 98](#).

INTRUDER

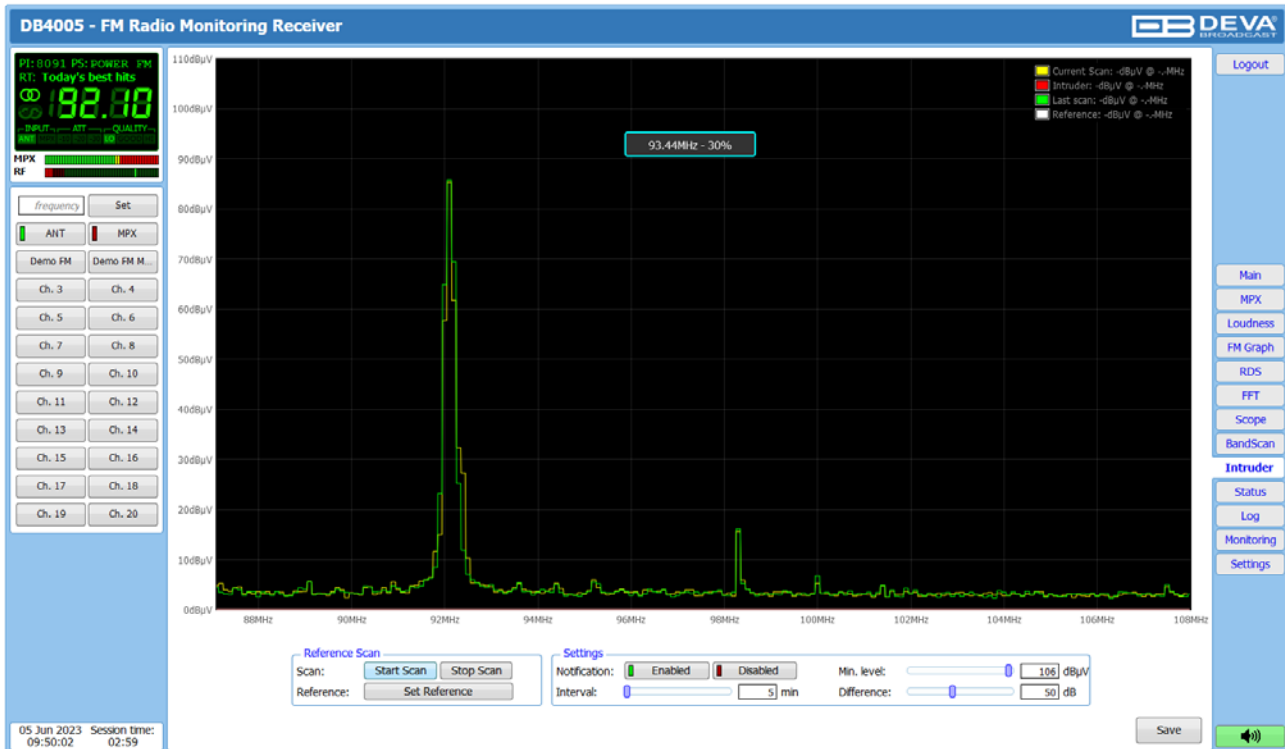

This option allows the user to set the needed parameters in order for the DB4005 to be able to perform an Intruder BandScan. The scan is made at a predefined time interval. In order for the option to be properly utilized, a reference bandscan should be made via the [Start Scan] and [Stop Scan] interactive buttons. Once the reference scan is set via the [Set Reference] button, all subsequent bandscans will be compared with it. Upon comparing the scans, the DB4005 will depict on the graph if an intruder station has been detected or if a radio station has disappeared. An email and Log notification will also be available.

The available user settings are:

- **Notification** – Enables/Disables the email notification option. If Enabled, you will receive email notification.
- **Interval** – sets the time interval at which a bandscan will be made;
- **Min. level** – sets the minimum levels at which a notification will be generated;
- **Difference** – sets the difference (in dB) between the two bandscans at which the DB4005 will accept that there is or there is not a radio station. For example, if the difference is set to 4 dB, a station registered at 2dB difference with the reference will not be indicated and email and Log notifications will not be available.

MONITORING



This section of the WEB Interface allows you to use a secondary tuner fed from Antenna input 2, to check the parameters of any frequency. The frequency can be manually set at the **Station** field and upon pressing the [Set] button. Quick access presets for several frequencies are also available. The **Presets** options are the same as the one set at the main screen and Logger. Just as on the Main Screen, the green [Listen] button (loudspeaker icon), allows you to listen to the tuned frequency remotely in your browser.

The Monitoring option allows the process to be performed without interruption of the Logger started on the main tuner. All the parameters are represented as LED bargraph readings. Basic RDS parameters, such as PI, PS and RT of the tuned frequency are displayed as well.

As an addition, Bandscan function to provide overview of the dial is also included. The Bandscan application utilizes four different types of Bandscan, depending on the preferred signal frequency step. The bandscanning mode could be customized by setting low and high frequency limits of the scan. Once you have set the frequency step and low/high frequencies, the [Start] button should be pressed in order for the Bandscan process to be initiated. The current scan could be stopped at any time by pressing the [Stop] button. Pressing the [Monitoring] button will switch back to the monitoring screen option.

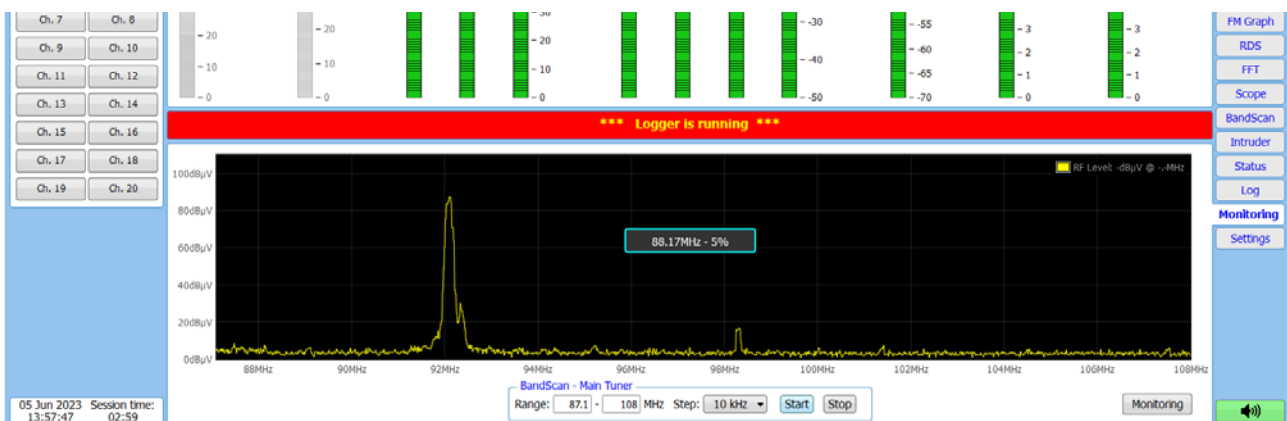

GENERAL SETTINGS SCREEN

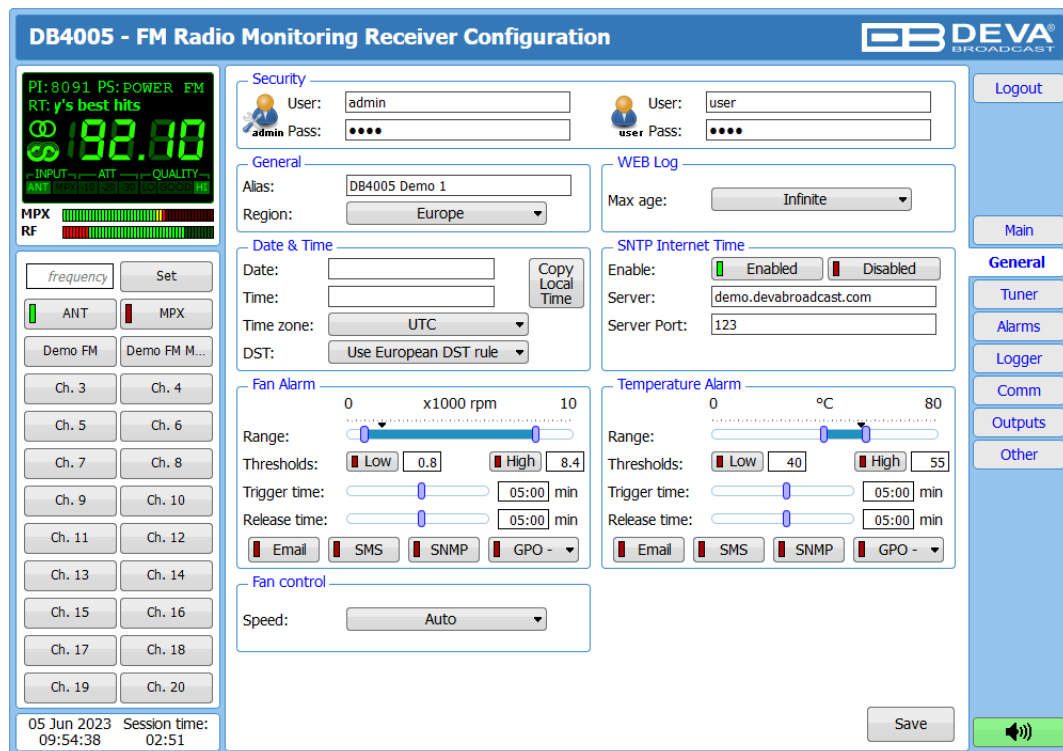

DB4005 provides you with protected access to the device settings. You can choose between two types of log in.

- **Administrator** – It will give you full control over the settings of the device;
- **User** – that will allow you to just monitor the device and to choose different stations, while the Settings bar remains locked.

In order for the security of DB4005 to be enhanced, a new username and password could be set from the “Security” section.

General – *Alias* - allow the name of the device to be changed. Later on, it will be used as a title name on all WEB pages. Customizing the name will make the device more recognizable.

Region – DB4005’s tuning range is user selectable, 87.1-108 MHz (CCIR), 65-74 MHz (OIRT), 76-95 MHz (Japan). Changing/selecting the Region setting, will modify all tuner frequencies so that they could be within the FM band limits of the region chosen. This includes all Presets and Logger Channel frequencies.

Fan control – set the preferred speed of the built-in Fan.

Date & Time – used for manually set the current Date and Time. “Copy Local Time” button will set the Date and Time to correspond to that of your computer.

SNTP Internet Time – Synchronizes automatically the DB4005 clock to a millisecond with the Internet time server. Enable this function in order to use it. (Specifying the server closest to your location will improve the accuracy).

Temperature Alarm – Detects abnormal temperature of the equipment. Define the parameters under which a temperature alarm to be generated;

Fan Alarm – Detects abnormal operation of the built-in fan. Define the parameters under which a fan alarm to be generated;

WEB Log – the maximum storage time of the System Log file is chosen from here. If the file is older than the specified maximum will be deleted.

NOTE: In order for the applied settings to be used press the “Save” button, placed on the bottom right part of the screen.

TUNER SETTINGS SCREEN

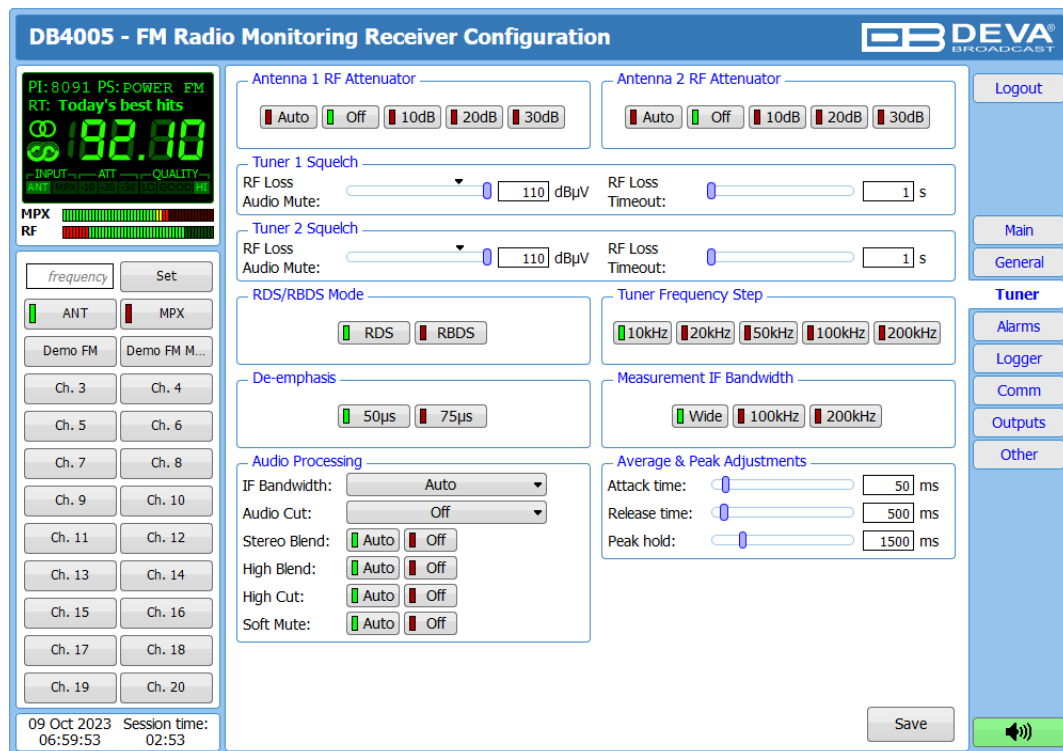

The Tuner Section gives full control over Tuner and Audio Processing and the RF Antenna Inputs settings.

These settings provide all the needed adjustments to the algorithm which DB4005 demodulates and manipulates the signal.

Antenna 1/Antenna 2 Attenuator Mode – Allows attenuator mode depending on the location of the device to be selected :

- It is possible to choose the preset attenuation value or Auto - device will automatically choose the proper set-up;

Tuner 1/Tuner 2 Squelch – this function mutes the audio in case of low RF level.

RDS/RBDS Mode – Depending on the client's preferences, the deviation could be measured in % [RBDS] or in kHz [RDS].

Tuner Frequency Step and De-emphasis – User defined frequency step and De-emphasis could also be set, where the default values are 50 kHz Frequency Step and 50µs De-emphasis.

Average & Peak Adjustments Section is used for setting of the indicators response times.

- **Attack time** and **Release time** set the rate in which the indicators' level will change in response to the signal. For most of the applications (including this one), the recommended attack time is shorter than the release time.

- **Peak-hold time** – Permits retaining and displaying the peak value reached by the signal for a period of time predefined by the user, in milliseconds.

Audio Processing – If set to Auto, these settings depend on the quality of the received signal (RF Level, Multipath, and etc.). If any changes in the signal are detected, the unit will automatically adjust to the correct values.

- Stereo Blend – reduces the stereo separation if the received signal is bad;
- High Blend – applies low pass filter to the L-R audio levels;
- High Cut – applies low pass filter to the L+R audio levels;
- Soft Mute – reduces the level of the audio if the RF level is too low.

ALARMS SETTINGS SCREEN

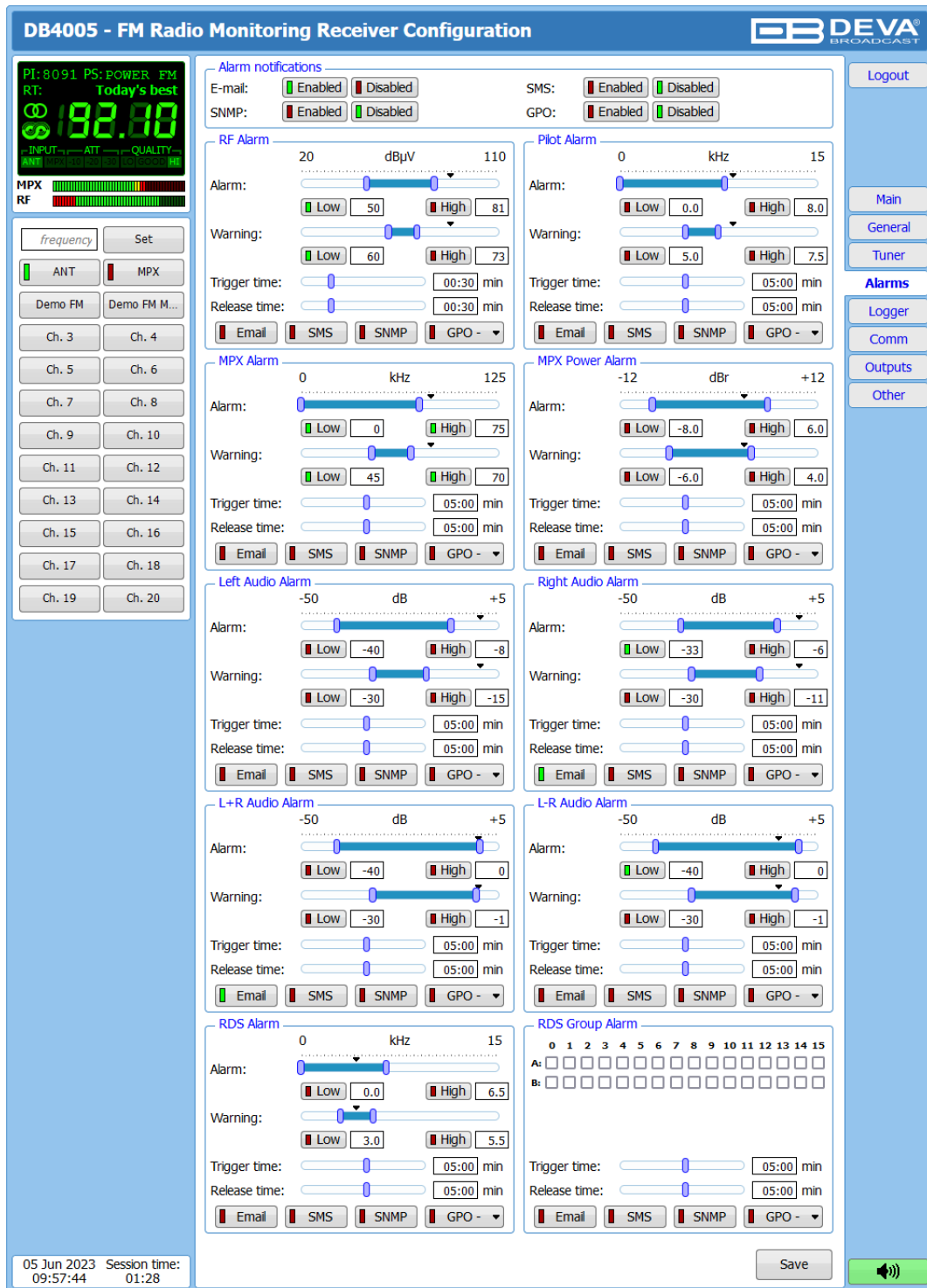

This tab gathers (and allows set-up) the so-called General alarms, which are constantly running nevertheless the user interference or Logger mode. Meaning that these alarms will be in effect even though the user is logged in via the WEB interface or DEVA Device Manager Software. The General alarms are monitoring the currently tuned station, and are intended to report the general condition of the toggled stations (if a threshold to cover all channels is set) as they monitor the entire measurement data flow, not just part of it. These alarms are reset at each frequency change. If the trigger time is longer than the channel observation time an alarm cannot be generated while the logger is running.

NOTE: If the General Alarms and Logger mode alarms ([“Logger Channel Settings” on page 78](#)) are enabled, and set to different parameters, alarm notifications from both alarm types will be sent and received.

Alarm Notifications

- E-mail – global enable/disable E-mail notification;
- SMS – global enable/disable SMS notification;
- SNMP – global enable/disable SNMP notification;
- GPO – global enable/disable GPO actions.

NOTE: If the monitoring option is disabled, notifications will not be sent, nevertheless whether they are enabled or disabled.

Alarm

- Range - interactive slider used to adjust the Low & High thresholds at which an alarm will be generated;
- Trigger Time – waiting time before Active Alarm is generated;
- Release Time – waiting time before Idle Alarm is generated;
- RDS/RBDS Group Alarm - alarm only for selected groups will be generated.

NOTE: For detailed information on Alarm trigger and notifications [refer to “Alarm Triggers” on page 95.](#)

LOGGER SETTINGS SCREEN

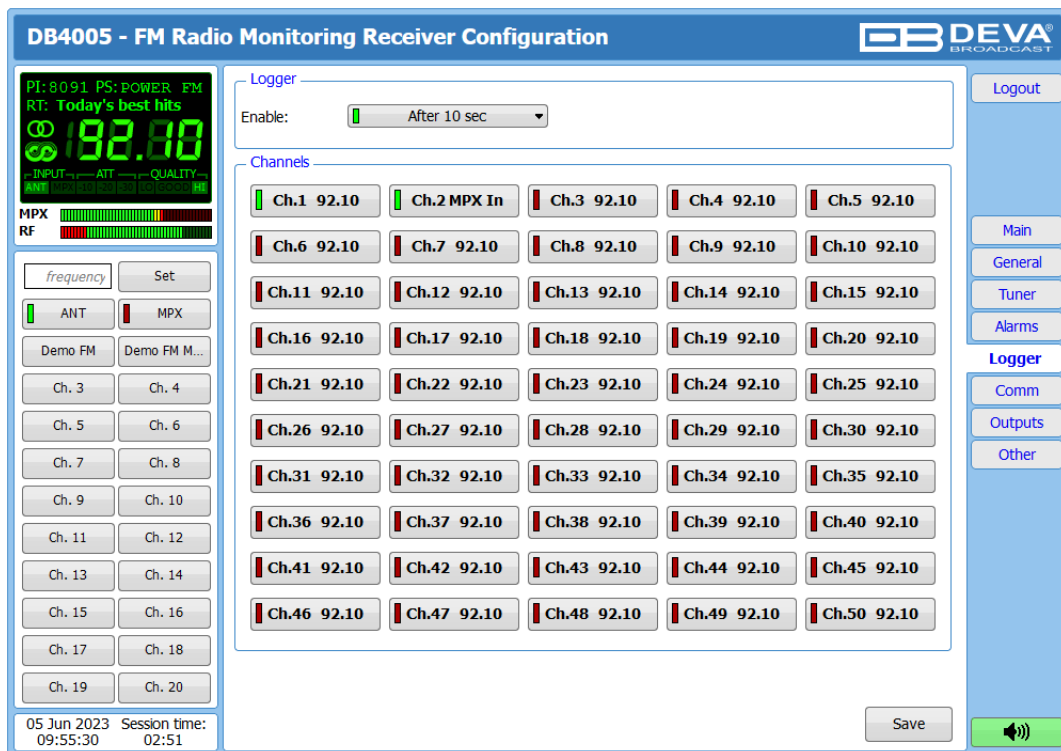

Trough this section of the WEB Interface, up to fifty radio frequencies could be chosen and monitored, by applying the needed settings.

When the desired adjustments are being made, DB4005 will monitor all of the selected frequencies at regular intervals. All of the collected information is accessible through the built-in FTP Server. ([see “Download files via FTP” on page 98](#))

Follow the steps below to initiate the simplified process of starting a Logger mode:

- Set the Logger’s start time delay;
- Click on a channel to open the settings page;
- Set the Name and Frequency parameters for each of the channels ([see “Logger Channel Settings” on page 78](#));
- Set the Acquisition time for each channel ([see “Logger Channel Settings” on page 78](#));
- In order for a channel to be included in the campaign, the “Ant1”/”Ant2” button should be selected. To exclude a station from the campaign select the “Disable” button ([see “Logger Channel Settings” on page 78](#)).

LOGGER CHANNEL SETTINGS

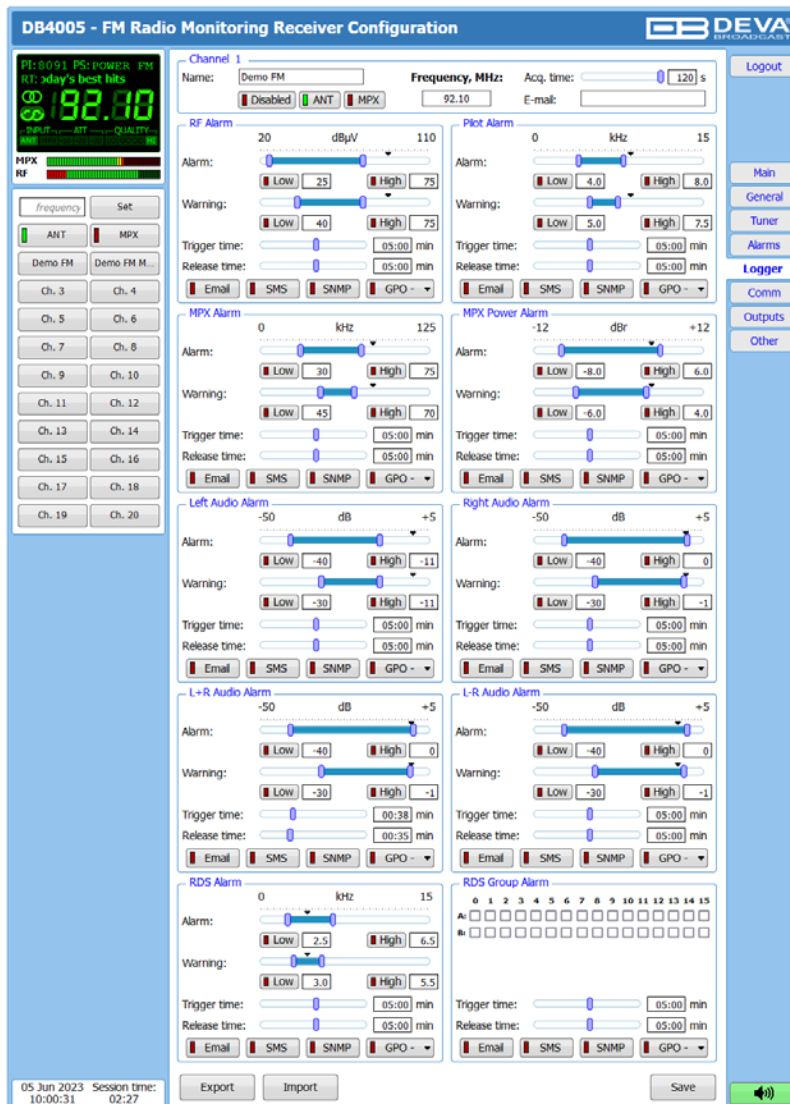

Every Channel consists of a group of settings (explained in details below), which are used when monitoring and alerting. Each preset has its own page where it is being configured. Measurement windows can be set for each of the alarms, including trigger and alarm release times.

Channel

- Name – channel alias;
- Enable/Disable – enables/disables channel monitoring;
- Frequency – specify the frequency to be monitored;
- Acquisition time – specify the observation time for the current station (before switching to the next channel);
- E-mail for alarm notification to be sent.

NOTE: When MPX Power alarm is enabled the observation time must be more than 60 seconds.

Alarm Notification Type

- E-mail – enables/disables E-mail notification;
- SMS – enables/disables SMS notification;
- SNMP – enables/disables SNMP notification;
- GPO – enable/disable GPO action.

Logger mode alarms allow individual alarms for a frequency to be set. The Logger mode is running only when there is no user interference. As up to 50 channels can be set, when in Logger mode the DB4005 will monitor the status of each channel on a rotation principle, and as per the user defined observation time. The alarm notification works as follows: if the observation time is set to 10 seconds, and during this time the RF level (for example) is below the specified threshold, but the timeout has not expired, an alarm will be generated upon the channel's next time slot if the level is still below the specified threshold and the timeout expires.

IMPORTANT NOTE: If the General Alarms ([“Alarms Settings Screen” on page 75](#)) and Logger mode alarms are enabled, and set to different parameters, alarm notifications from both alarm types will be sent and received.

NOTE: If the notification option is global disabled, notifications will not be sent, irrespective of whether they are enabled or disabled.

Alarm

- Range (Thresholds) – interactive slider used to adjust the Low & High thresholds on which an alarm will be generated;
- Trigger Time – waiting time before Active Alarm is generated;
- Release Time – waiting time before Idle Alarm is generated;
- RDS/RBDS Group Alarm – an alarm only for selected groups will be generated.

NOTE: For detailed information on Alarm trigger and notifications [refer to “Alarm Triggers” on page 95](#).

Export

Pressing [Export] will export the settings applied to a particular channel. This option is very useful when several devices in one region are used, or just to store the information for future usage. To export the settings, follow the instructions below:

1. Press [Export], a new dialog window will appear;
2. Choose a directory to save the (*.ssi) file;
3. Press [Save].

Import

Allows you to import a preliminary saved settings. To import the (*.ssi) file, follow the instructions below:

1. Press [Import], a new dialog window will appear;
2. Choose the (*.ssi) file to be uploaded;
3. Press [OK] and wait for the process to be completed;
4. Press [Save] to save the changes.

HOW TO START A LOGGER CAMPAIGN?

NOTE: The first 20 channels set in the Logger tab will appear as station presets on the left section of the WEB interface.

Prior to applying any settings, a connection to the device via the WEB Interface should be made.

1. Open the main application window and go to *Settings*> *Logger* tab;
2. Set the Campaign's start time delay from the "Logger" box placed at the top of the window;

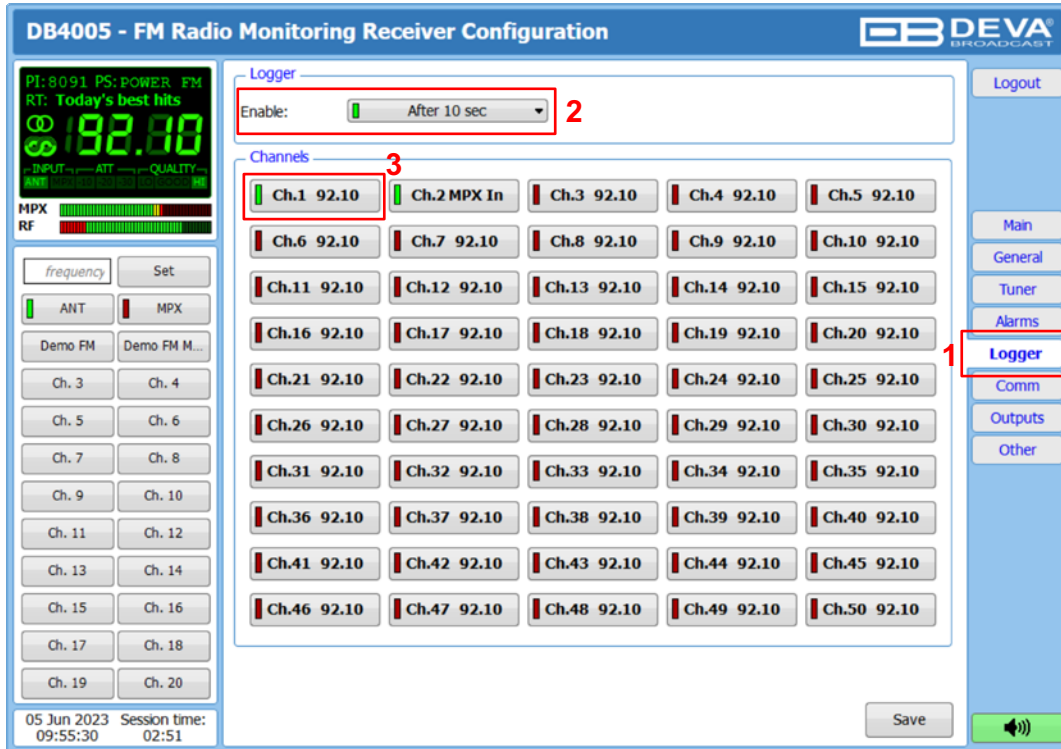

3. Click on a Channel to be set;

- Set the Name, Frequency and Acquisition time parameters for each of the channels. In order for a station to be included in the campaign, the [Ant1] button should be selected; to exclude a station from the campaign the [Disable] button should be selected;

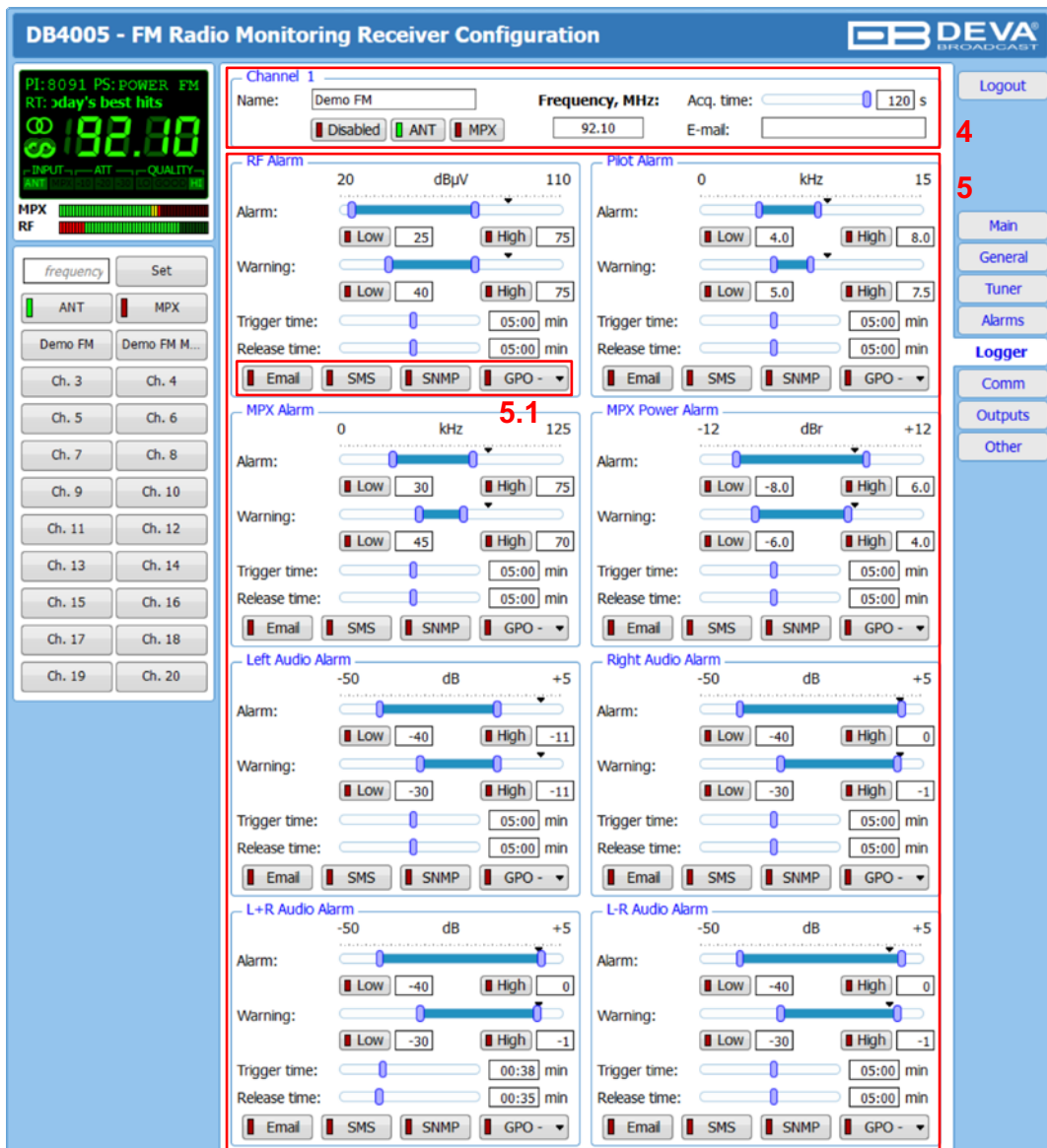

- Change the alarm parameters as per your preferences. In order for an alarm to be generated, a preferred notification method should be chosen (5.1).
 - RF Alarm** – alarm settings for RF level
 - MPX Alarm** – alarm settings for MPX total modulation
 - MPX Power Alarm** – alarm settings for MPX power
 - Pilot Alarm** – alarm settings for Pilot tone deviation
 - RDS Power Alarm** – alarm settings for RDS subcarrier deviation
 - RDS Group Alarm** – alarm settings for RDS group presence
 - Left Alarm** – alarm settings for Left audio signal level
 - Right Alarm** – alarm settings for Right audio signal level
- Press the [Save] button to save the applied changes;
- Steps from 2 to 6 should be applied for each of the channels to be monitored. Once all channels are set you can proceed to the last step;

NOTE: In order for a campaign to be commenced the device should be inactive for the specified time. During the campaign, the device should be inactive. The front panel navigational menu, WEB Interface and Device Manager Software should not be used.

COMMUNICATION SETTINGS SCREEN

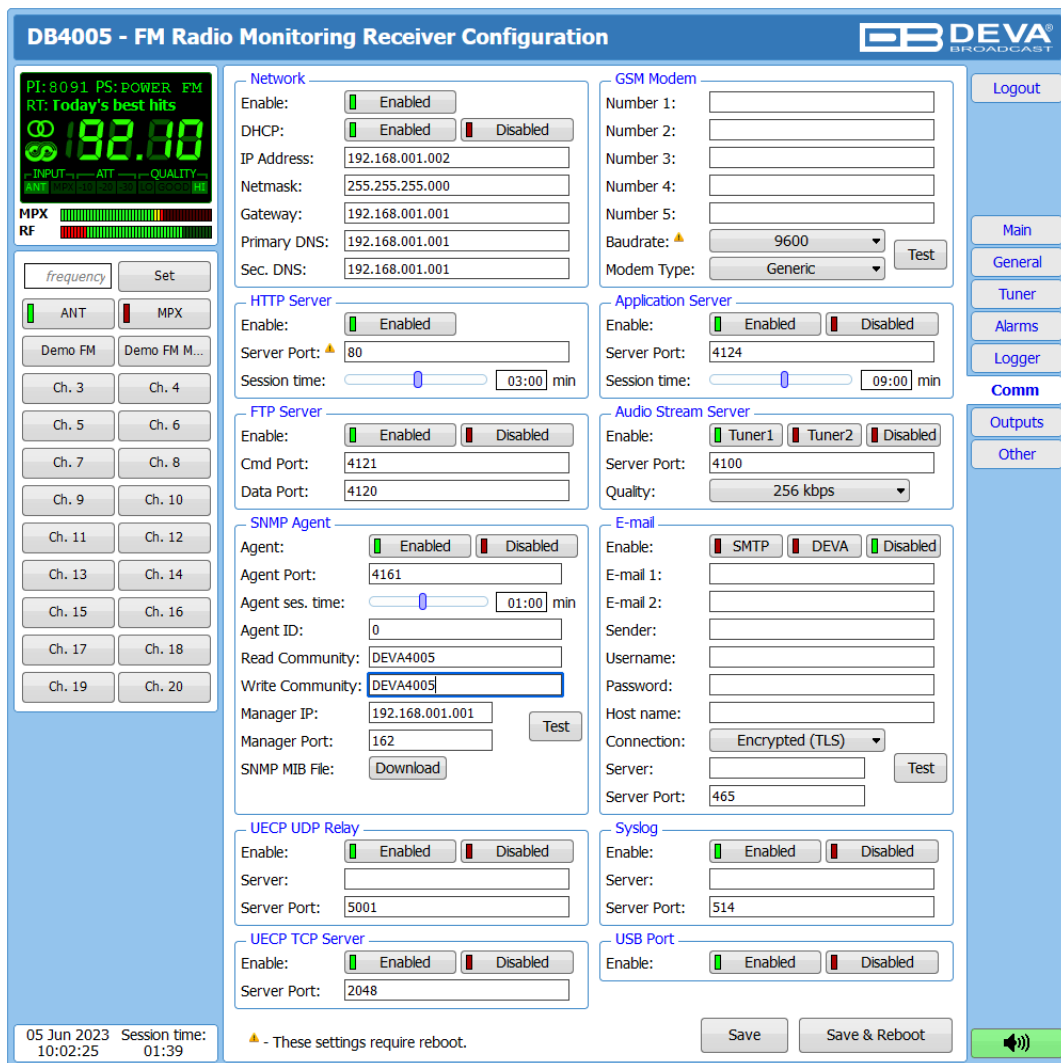

Network

The network addresses could be set manually (static IP) or automatically via a DHCP server. To set static IP, MASK, GATEWAY and DNS addresses, the DHCP should be disabled. In order for the built-in DHCP client to be activated, the function should be enabled. When the DHCP client is activated, all assigned values will be shown in the relevant fields on the “Status Screen”. If due to any reason, the DHCP procedure cannot be completed, DB4005 will use AutoIP and will generate an IP Address.

HTTP Server

Enable/Disable the HTTP Server. Specify the Server Port and session timeout.

FTP Server

Enable/Disable the FTP Server. Specify the Command and Data Ports to be used.

SNMP Agent

Specify Agent ID, Agent Port, Read/Write Communities, Manager IP, Manager Port and session timeout.

Agent - enables/disables SNMP Agent.

Agent ID is used for identification of the device among others, when an SNMP notification is being sent.

Once all needed settings are applied, use the Test button to generate a test notification, which upon success will be received by the SNMP Manager.

Press the 'Download' button to download the latest available DB4005 SNMP MIB file.

NOTE: The MIB file may vary from one firmware revision to another. Downloading this file from the device, guarantees that you have the proper MIB file.

Syslog

Enable or disable the Syslog feature. Specify Server address and port to be used.

GSM Modem

Up to five numbers for SMS control and alarm notifications could be set. Baud Rate is mandatory for the proper operation of the GSM Modem.

We recommend that a test SMS to be generated (via pressing the 'Test' button), once all needed settings are applied. Upon success, the SMS will be delivered to all the specified GSM numbers.

Example of Test SMS Message:

DB4005 Test Message.

NOTE: The current condition of the GSM Modem could be checked in the "Status Screen".

Application Server

Enable/Disable the DEVA Device Manger Application Server. Specify the Server Port and session timeout.

Audio Stream Server

Specify Tuner and Port for audio Streaming, and Quality (64, 96, 128, 192 or 256 kbps). The Audio Stream could be heard using suitable audio player (Media Player, Winamp, etc.) or through the WEB interface by pressing the "Listen" button.

E-mail

Enter the desired alarm recipients in e-mail 1 and/or e-mail 2 fields. Fill in your e-mail account settings: Sender, Username and Password, Server, SNMP port and connection type. It is mandatory the type of connection with the server to be specified from Connection - Regular, Encrypted. The Server port will be changed accordingly. Please note that the most commonly used port will be entered in the field. If the port that is to be used is different, change it manually to the correct value.

If you experience difficulties in the set-up, or would like to use DEVA account for sending of alarm email notifications, press the [DEVA] button option, and complete the recipient emails (E-mail 1 and E-mail 2) only. The other fields must be left blank, otherwise the email notification option will not be working. Event though using the DEVA account eases the set-up process, we recommend user account to be used for sending of email notifications, , and the DEVA account for test purposes. When using DEVA account, please note that the stable 24/7 connection depends on the mail service provider and cannot be guaranteed.

We recommend you to use the 'Test' button and generate a test e-mail, which upon success will be delivered to the specified E-mail 1 and/or E-mail 2.

Example of Test E-mail Message:

DB4005 Test Message.

Please do not reply to this e-mail.

UECP Relay

The unit can relay the received RDS as a UECP stream. There are two possible options:

Option 1 – via UDP, where the device sends the received RDS as UECP encoded UDP packets unconditionally to the specified IP Address and Port. The receiver could be an RDS/RBDS Encoder SmartGen, other RDS Encoder, or Monitoring Software.

Option 2 – via TCP. The unit has built in server and a Monitoring Software to receive the UECP encoded RDS data could be connected to the unit.

USB Port

Enable/Disable the USB port.

WARNING: The applied changes will take effect upon pressing the “Save” button. All settings marked with 🚨 require Reboot, therefore the Save & Reboot button should be used.

NOTE: The edited field will become red if the new value is invalid or out of range.

OUTPUTS SETTINGS SCREEN

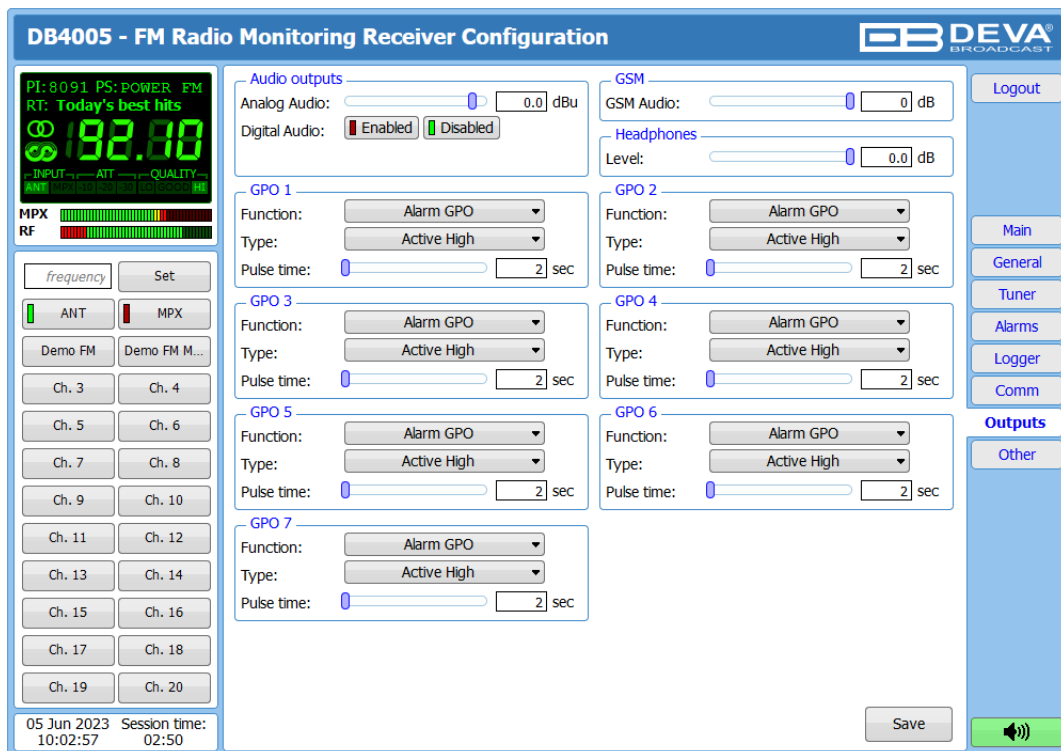

The general purpose outputs settings are applied through this page. The Audio Outputs section allows the setting of the Audio outputs, according to your needs.

Function, type and pulse time for each of the GPOs could be set individually. You can choose between the following functions: Alarm GPO, RDS Lock, TA Flag and TP Flag. ‘Type’ is used for specifying of the active level. When an alarm is generated the output can change the level to Active High/Low or to generate High/Low Pulse.

PLEASE NOTE that if the GPO’s function is not assigned as “Alarm GPO” and the selfsame is chosen as a preferred alarm, notifications will not be indicated, nevertheless one is being generated.

OTHER SETTINGS SCREEN

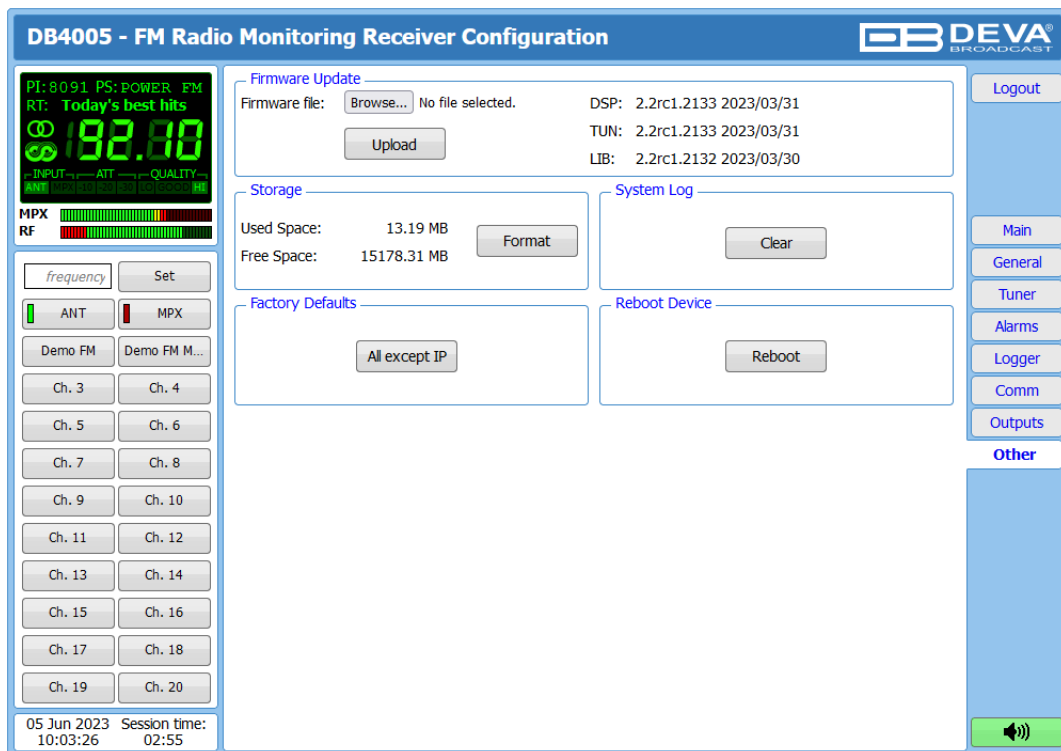

Firmware Update

To update the device firmware, select the new firmware file. After having pressed the Upload button, a dialog window will appear. Confirm the firmware update and wait for the process to complete. Information on current DSP, TUN and WEB version is also found in this section.

Storage

Information about the device storage space is found in this section. The entire internal storage could be deleted by pressing the 'Format' button.

System Log

By pressing the 'Clear' button, all records in the System log will be deleted.

Factory Defaults

- All except IP – all settings, except for the Network settings (IP Address) will be deleted;
- Channels – all settings applied to the channels of the Logger and the RDS PI/RBDS Call campaign will be switched back to the factory defaults.

To restore DB4005 to its Factory Defaults you should first select the desired option and then press the relevant button. A new window will appear – confirm that you want to restore the factory defaults and wait for the process to be completed. On completion of the process, the settings should have the proper default values.

Reboot

To start Rebooting of DB4005, press the Reboot button. A dialog warning window will appear. Confirm that you want to reboot the device and wait for the process to be completed.

APPENDIX A

LIST OF DB4005 SETTINGS

Parameter Name	Type	Range	Default value [, Unit]	Description
TUNER				Tuner related submenu
Frequency	INT	User selectable, 87.1-108 MHz (CCIR), 65-74 MHz (OIRT), 76-95 MHz (Japan)	98, MHz	Currently set frequency
Attenuator Ant 1	ENUM	Auto, OFF, -10, -20, -30	Auto, dB	Attenuator setting for antenna input 1
Frequency Step	ENUM	10, 20, 50, 100	50, kHz	Step for frequency tuning
IF Bandwidth	ENUM	27, 36, 45, 53, 62, 71, 79, 88, 97, 105, 114, 123, 131, 140, 149, 157, Auto	Auto, kHz	IF filter bandwidth
Stereo Blend	ENUM	Auto, Off	Auto	Stereo blend control
High Cut	ENUM	Auto, Off	Auto	High cut control
High Blend	ENUM	Auto, Off	Auto	High blend control
Soft Mute	ENUM	Auto, Off	Auto	Soft mute control
Audio Cut	ENUM	5, 10, 15, Off	Off, kHz	Audio cut control
Deemphasis	ENUM	FLAT, 50, 75	50, μ s	De-emphasis settings
RDS Mode	ENUM	RDS, RBDS	RDS	RDS decoder mode
AVERAGE AND PEAK				Signal averaging related submenu
Attack Time	INT	0 ... 500, step 10	50, ms	Attack time for signal measuring
Release Time	INT	50 ... 1000, step 10	500, ms	Release time for signal measuring
Peak Hold	INT	500 ... 5000, step 500	1500, ms	Peak hold time
COMMUNICATION				Communication related submenu
GENERAL SETUP				General communication settings
Ethernet	ENUM	Enable, Disable	Enable	Ethernet port (general)
SNMP	ENUM	Enable, Disable	Enable	SNMP protocol
Application	ENUM	Enable, Disable	Enable	Application proprietary protocol
HTTP	ENUM	Enable, Disable	Enable	HTTP protocol (WEB server)

Parameter Name	Type	Range	Default value [, Unit]	Description
FTP	ENUM	Enable, Disable	Enable	FTP protocol
Email	ENUM	Enable, Disable	Enable	SMTP protocol (email)
SNTP	ENUM	Enable, Disable	Enable	SNTP protocol (Internet time)
Audio Stream	ENUM	Enable, Disable	Enable	Audio streaming
Syslog	ENUM	Enable, Disable	Enable	SYSLOG protocol
USB	ENUM	Enable, Disable	Enable	USB port
UPnP	ENUM	Enable, Disable	Enable	UPnP protocol
ETHERNET				Ethernet related submenu
DHCP	ENUM	Enable, Disable	Enable	DHCP Client
IP	IP		192.168.1.2	IP address (static)
Network Mask	NETMASK		255.255.255.0	Network mask (static)
Gateway	IP		192.168.1.1	Gateway address (static)
Primary DNS	IP		192.168.1.1	Primasy DNS IP address (static)
Secondary DNS	IP		192.168.1.1	Secondary DNS IP address (static)
WAN IP	IP		192.168.1.2	IP address used for FTP behind NAT
SNMP				SNMP related submenu
Manager IP	IP		192.168.1.1	Manager IP address
Manager Port	PORT	1 ... 65535, step 1	162	Manager port
Agent Port	PORT	1 ... 65535, step 1	161	Agent port
Agent ID	INT	0 ... 255, step 1	0	Agent ID for the device
Read Community	STR		DEVA4005	Read community password
Write Community	STR		DEVA4005	Write community password
Session Timeout	TIMER	10 ... 3600, step 10	180, sec	Inactivity timeout - for SNMP write only
APPLICATION				Application related submenu
Port	PORT	1 ... 65535, step 1	1024	Application port
Session Timeout	TIMER	10 ... 3600, step 10	180, sec	Application inactivity timeout

Parameter Name	Type	Range	Default value [, Unit]	Description
HTTP				HTTP related submenu
Port	PORT	1 ... 65535, step 1	80	WEB server port
Session Timeout	TIMER	10 ... 3600, step 10	180, sec	WEB session timeout
FTP				FTP related submenu
Data Port	PORT	1 ... 65535, step 1	2020	FTP data port
Command Port	PORT	1 ... 65535, step 1	21	FTP command port
SNTP				SNTP related submenu
Time Server	HOST		pool.ntp.org	Time server host name
Server Port	PORT	1 ... 65535, step 1	123	Time server port
EMAIL				Email related submenu
Mail Server	HOST		mail.host.bg	Outgoing server host name
Server Port	PORT	1 ... 65535, step 1	25	Outgoing server port
Email Address 1	EMAIL		(blank)	First recipient email address
Email Address 2	EMAIL		(blank)	Second recipient email address
Sender Name	STR		db4005@devamonitoring.com	Sender name
User Name	STR		(blank)	Outgoing server user name
User Password	STR		(blank)	Outgoing server password
STREAMER				Audio streamer related submenu
Server Port	PORT	1 ... 65535, step 1	5000	Audio streamer server port
Bitrate	INT	64 ... 128, step 32	128, kbps	Audio bitrate
SYSLOG				SYSLOG related submenu
Server	HOST			Server host name
Port	PORT	1 ... 65535, step 1	514	Server port
GSM MODEM				GSM modem related submenu
Modem Type	ENUM	Generic	Generic	Denotes used GSM modem type
Baudrate	ENUM	4800, 9600, 19200, 38400, 57600	9600, bps	GSM modem communication speed

Parameter Name	Type	Range	Default value [, Unit]	Description
Number 1	TEL		(blank)	First allowed phone number
Number 2	TEL		(blank)	Second allowed phone number
Number 3	TEL		(blank)	Third allowed phone number
Number 4	TEL		(blank)	Fourth allowed phone number
Number 5	TEL		(blank)	Fifth allowed phone number
SECURITY				Security related submenu
PANEL				Panel security settings
Access Control	ENUM	Enable, Disable	Disable	Front panel access control
Access Code	PORT	0 ... 9999, step 1	1234	Front panel access code
Access Timeout	TIMER	60 ... 3600, step 1	300, sec	Access is granted timeout
REMOTE ACCESS				Remote control security settings
Admin Name	STR		admin	Admin access level name
Admin Password	STR		pass	Admin access level password
User Name	STR		user	User access level name
User Password	STR		pass	User access level password
ALARMS				Alarms related submenu
ALARM EVENTS				Alarm events control settings
Email	ENUM	Enable, Disable	Enable	Alarm through email
SMS	ENUM	Enable, Disable	Enable	Alarm through SMS
SNMP Trap	ENUM	Enable, Disable	Enable	Alarm through SNMP trap
GPO	ENUM	Enable, Disable	Enable	Alarm through GPO pin
ALARMS GPO				GPO pins settings
GPO1 Type	ENUM	Level High, Level Low, Pulse High, Pulse Low	Level High	GPO pin 1 active level
GPO1 Pulse Time	TIMER	1 ... 120, step 1	2, sec	GPO pin 1 pulse duration
GPO2 Type	ENUM	Level High, Level Low, Pulse High, Pulse Low	Level High	GPO pin 2 active level
GPO2 Pulse Time	TIMER	1 ... 120, step 1	2, sec	GPO pin 2 pulse duration
GPO3 Type	ENUM	Level High, Level Low, Pulse High, Pulse Low	Level High	GPO pin 3 active level

Parameter Name	Type	Range	Default value [, Unit]	Description
GPO3 Pulse Time	TIMER	1 ... 120, step 1	2, sec	GPO pin 3 pulse duration
GPO4 Type	ENUM	Level High, Level Low, Pulse High, Pulse Low	Level High	GPO pin 4 active level
GPO4 Pulse Time	TIMER	1 ... 120, step 1	2, sec	GPO pin 4 pulse duration
GPO5 Type	ENUM	Level High, Level Low, Pulse High, Pulse Low	Level High	GPO pin 5 active level
GPO5 Pulse Time	TIMER	1 ... 120, step 1	2, sec	GPO pin 5 pulse duration
GPO6 Type	ENUM	Level High, Level Low, Pulse High, Pulse Low	Level High	GPO pin 6 active level
GPO6 Pulse Time	TIMER	1 ... 120, step 1	2, sec	GPO pin 6 pulse duration
GPO7 Type	ENUM	Level High, Level Low, Pulse High, Pulse Low	Level High	GPO pin 7 active level
GPO7 Pulse Time	TIMER	1 ... 120, step 1	2, sec	GPO pin 7 pulse duration
RF Alarm	ALARM	see “Note 1”		RF level alarm settings
MPX Alarm	ALARM	see “Note 1”		MPX total deviation alarm settings
MPX Power Alarm	ALARM	see “Note 1”		MPX power alarm settings
Pilot Alarm	ALARM	see “Note 1”		Pilot level alarm settings
RDS Alarm	ALARM	see “Note 1”		RDS subcarrier level alarm settings
RDS Group Alarm	ALARM	see “Note 1”		RDS group presence alarm settings
Left Alarm	ALARM	see “Note 1”		Left audio level alarm settings
Right Alarm	ALARM	see “Note 1”		Right audio level alarm settings
Temperature Alarm	ALARM	see “Note 1”		Device temperature alarm settings
Fan Speed Alarm	ALARM	see “Note 1”		Device fan speed alarm settings
LOGGER				Logger related submenu
Logger Mode	ENUM	Disable, 1, 2, 5, 10	Disable, min	Logger mode start time delay
Channel 1	CHANNEL	see “Note 2”		Settings for logger channel 1
....
Channel 50	CHANNEL	see “Note 2”		Settings for logger channel 50
AUDIO / MPX OUTPUTS				Audio / MPX output related submenu
Phones Volume	INT	-60 ... 0, step 1	-12, dB	Head phones audio level
Audio Volume	INT	-60 ... 6, step 1	0, dB	Audio output level

Parameter Name	Type	Range	Default value [, Unit]	Description
GSM Volume	INT	-60 ... 0, step 1	0, dB	GSM audio level
Digital Out	ENUM	Enable, Disable	Disable	Digital audio output control
DEVICE				Device related submenu
Alias	STR		DB4005	Alias name for device
DATE / TIME				Date / Time settings
Date	DATE	01-Jan-2012 ... 31-Dec-2100	dd-mm-yyyy	Manual set Date
Time	TIME	0:0:0 ... 23:59:59, step 1	hh:mm:ss	Manual set Time
Timezone	TZONE	-12:00 ... 14:00, step 30 min	hh:mm	Timezone
FRONT PANEL				Front panel settings
Display Brightness	INT	0 ... 100, step 10	50, %	Display brightness
Display Contrast	INT	0 ... 100, step 10	100, %	Display contrast
LED Brightness	INT	0 ... 100, step 10	60, %	LED bars brightness
Screen Saver	ENUM	Disable, 1, 2, 5, 10	2, min	Screen saver control
Panel Timeout	TIMER	10 ... 600, step 10	10, sec	Panel inactivity timeout
LOSS				Audio loss LED settings
Threshold	INT	-100 ... 0, step 1	-50, dB	Active threshold level
Timeout	TIMER	1 ... 60, step 1	1, sec	LED activation delay
Home Screen	INT	0 ... 3, step 1	1	Select Device's home screen
Fan Control	ENUM	Auto, 25, 50, 75, 100	Auto, %	Fan speed control
FACTORY DEFAULTS				Factory defaults settings
Apply to	ENUM	None, Channels, Retain Comm, All	None	Selects parameter group to apply defaults
Execute	ENUM	Done, Proceed	Done	Revert defaults to selected parameter group

NOTE 1: Default values for complex alarm parameters are as follows:

Parameter Name	Type	Range	Default value [,Unit]	Description
FOR ALL ALARMS				
Trigger	TIMER	1 ... 600, step 1	300, sec	Alarm active event delay
Release	TIMER	1 ... 600, step 1	300, sec	Alarm idle event delay
SMS	ENUM	ON, OFF	OFF	SMS notification control
Email	ENUM	ON, OFF	OFF	Email notification control
SMNP	ENUM	ON, OFF	OFF	SNMP notification control
GPO	ENUM	1, 2, 3, 4, 5, 6, 7, OFF	OFF	GPO pin assignment control
RF ALARM				
Low threshold	INT	20 ... (High threshold)	25, dB μ V	Low alarm trigger level
High threshold	INT	(Low threshold) ... 100	75, dB μ V	High alarm trigger level
MPX ALARM				
Low threshold	INT	0 ... (High threshold)	30, kHz	Low alarm trigger level
High threshold	INT	(Low threshold) ... 125	75, kHz	High alarm trigger level
MPXPWR ALARM				
Low threshold	INT	-12 ... (High threshold)	-8, dBr	Low alarm trigger level
High threshold	INT	(Low threshold) ... 12	6, dBr	High alarm trigger level
PILOT ALARM				
Low threshold	INT	0 ... (High threshold)	4, kHz	Low alarm trigger level
High threshold	INT	(Low threshold) ... 15	8, kHz	High alarm trigger level
RDS ALARM				
Low threshold	INT	0 ... (High threshold)	2.5, kHz	Low alarm trigger level
High threshold	INT	(Low threshold) ... 15	6.5, kHz	High alarm trigger level
LEFT ALARM AND RIGHT ALARM				
Low threshold	INT	-50 ... (High threshold)	-40, dB	Low alarm trigger level
High threshold	INT	(Low threshold) ... 5	0, dB	High alarm trigger level
TEMPERATURE ALARM				
Low threshold	INT	0 ... (High threshold)	20, °C	Low alarm trigger level

Parameter Name	Type	Range	Default value [,Unit]	Description
High threshold	INT	(Low threshold) ... 80	70, °C	High alarm trigger level
FAN ALARM				
Low threshold	INT	500 ... (High threshold)	800, rpm	Low alarm trigger level
High threshold	INT	(Low threshold) ... 10000	5000, rpm	High alarm trigger level
RDS GROUP ALARM				
Group selector	-	All groups deselected		RDS Group selector

NOTE 2: Default values for complex channel parameters are as follows:

Parameter Name	Type	Range	Default value [,Unit]	Description
LOGGER CHANNEL 1 ... 50				
Name	STR	Name	Channel name	
Frequency	INT	User selectable, 87.1-108 MHz (CCIR), 65-74 MHz (OIRT), 76-95 MHz (Japan)	98, MHz	Channel frequency
Active	ENUM	Disable, Enable	Disable	Channel activity control
Acquisition Time	TIMER	5 ... 120, step 1	10, sec	Channel acquisition time
RF Alarm	ALARM		see “Note 1”	RF level alarm settings
MPX Alarm	ALARM		see “Note 1”	MPX modulation alarm settings
MPX Power Alarm	ALARM		see “Note 1”	MPX power alarm settings
Pilot Alarm	ALARM		see “Note 1”	Pilot level alarm settings
RDS Alarm	ALARM		see “Note 1”	RDS level alarm settings
RDS Group Alarm	ALARM		see “Note 1”	RDS groups alarm settings
Left Alarm	ALARM		see “Note 1”	Left audio level alarm settings
Right Alarm	ALARM		see “Note 1”	Right audio level alarm settings

APPENDIX B

ALARM TRIGGERS

After collecting all the data, the DSP-based core compares the values measured with the predefined by the user threshold levels, for all the alarms monitored. In case that a parameter is beyond limits, the device will initiate the sending of an alarm notification via the selected communication path. All the alarm events are stored in the device's log. It is essential that, if there is a very short fault of the signal, with duration shorter than the 'alarm trigger time', the device would not trigger an alarm.

There are several Alarm Triggers for the following parameters: RF, MPX, MPX Power, Left/Right Audio, RDS Group loss, Pilot and RDS levels. An option for defining different limits for each of the parameters is present. All these values, the 'trigger time' and the 'release time' have to be assigned separately for each of the alarms.

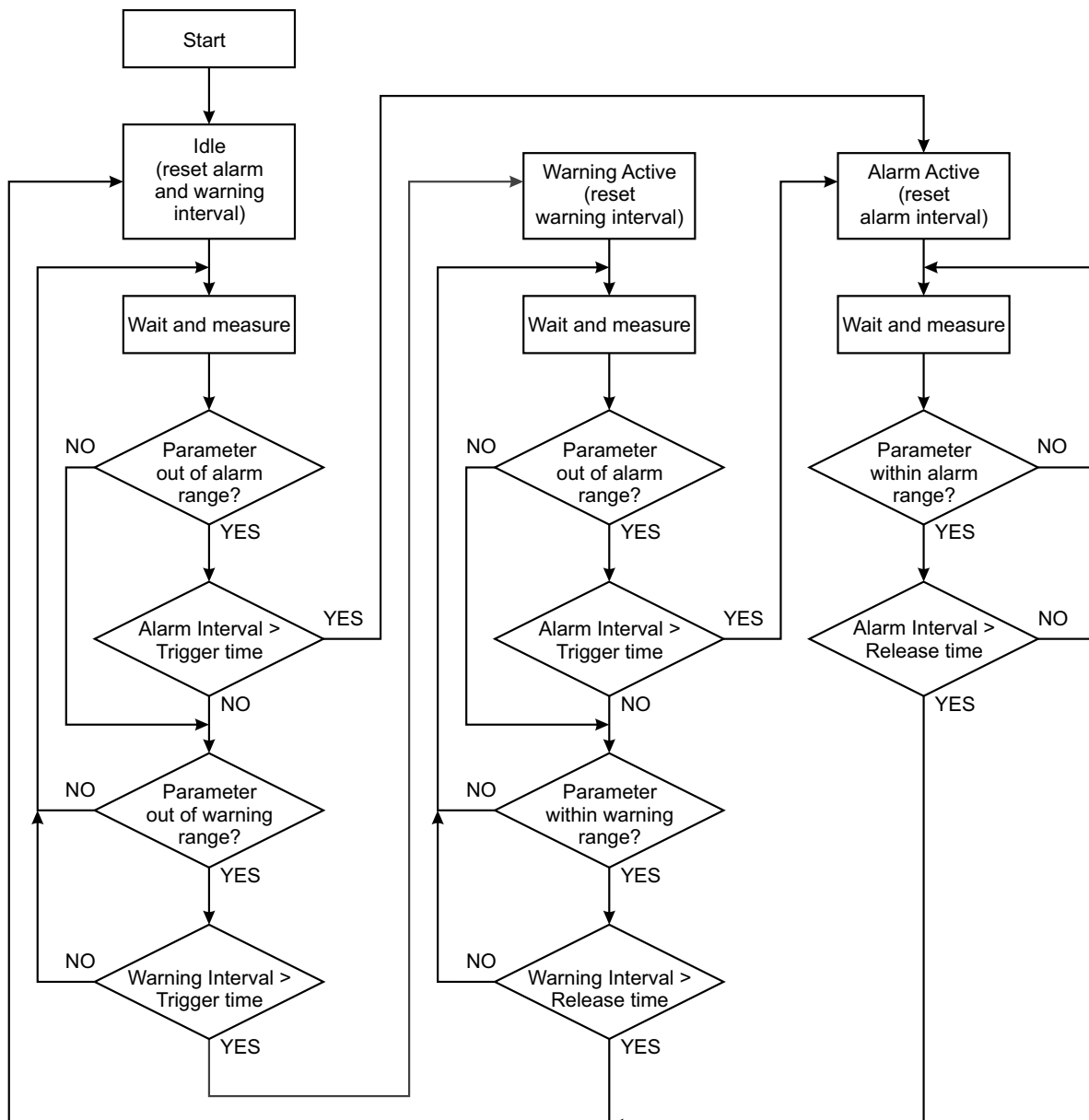

Block Diagram of Alarm Automata

When an observation event takes place, the Alarm Trigger's State will refresh, if necessary. Should we consider an instance when the Alarm Trigger is in Idle state, having in mind that an alarm is not triggered immediately when a parameter level passes beyond threshold: If the parameter level becomes stable, within Thresholds, and the Alarm Trigger Time is not elapsed, then the Alarm Trigger remains in Idle state. If the Alarm Trigger Time expires and the parameter level is still beyond limits, the Alarm Trigger would change its state to High/Low. This would result in predefined actions - Alarm Notifications (E-mail, SMS, SNMP trap) and Save a Log Record. The state will not be immediately switched into Idle when the parameter stabilizes, within Threshold levels, not up until the 'Alarm Release Time' is elapsed. Meanwhile, if the parameter crosses again any Threshold, the Alarm Trigger will remain in Active state. If the parameter remain within the Threshold levels and the Alarm Release Time expires, then the Alarm Trigger would switch into Idle state and again predefined actions would be initiated.

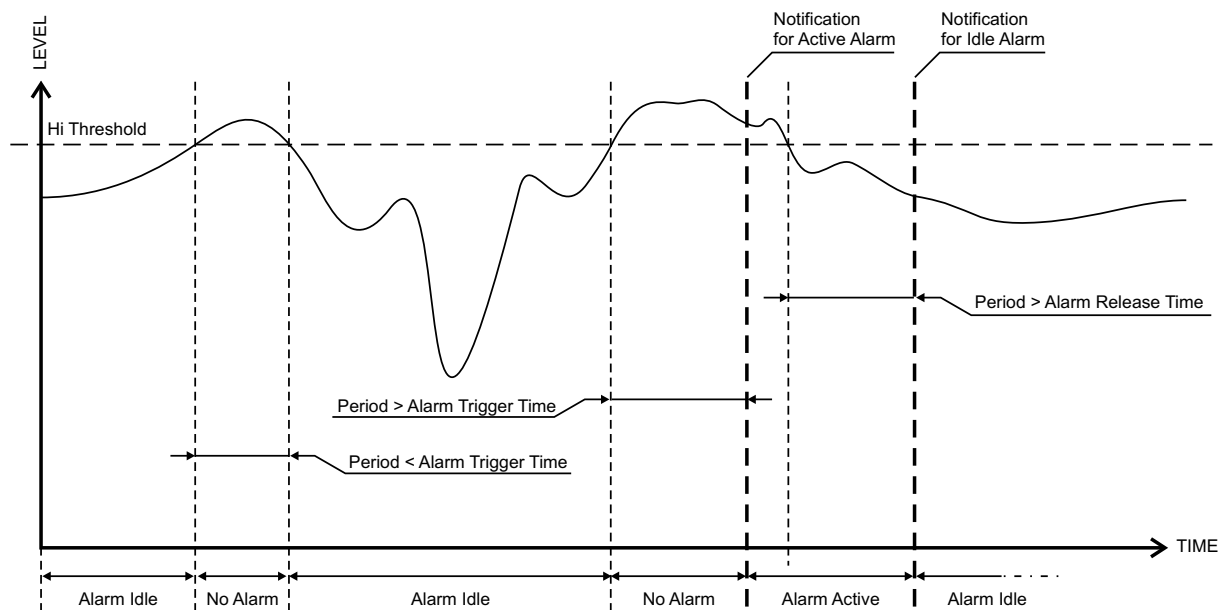

If the RDS Group has not been received within the Alarm Trigger Time, the state would be changed into Active. If the Active state and the Release Time have elapsed and the RDS Group is received, the state is changed to Idle. Should the RDS Group is received before the Release Time is elapsed, the state would remain Active.

IMPORTANT NOTE: When in Logger Mode, the alarm notification works as follows: if the observation time is set to 10 seconds, and during this time the RF level (for example) is below the specified threshold, but the timeout has not expired, an alarm will be generated upon the channel's next time slot if the level is still below the specified threshold and the timeout expires.

ALARM NOTIFICATIONS

The E-mail, SMS, SNMP trap Alarm Notifications contain the following information - device's Alias, date and time of Alarm triggered, channel number, frequency and information about the Alarm activation/deactivation. The basic signal parameters are also included.

Example for E-mal Notification:

Date: 04 Nov 2018, 07:31:11

DB4005 reports ACTIVE alarm on 0x1234 - Power FM (CH1)

Alarm: S/N Ratio < 16dB

Signal parameters:

RF: 31dBuV

DAB: LOSS

S/N Ratio: 0dB

CNR: 0dB

Left: -60.0dB

Right: -60.0dB

FIC Quality: 0%

Example for SMS Notification:

ACTIVE ALARM:CH1

27.09.2018 09:08:34

SERV:0x1234

RF:31dBuV

DAB:LOSS

SNR:0dB *L*

CND:0dB

Left:-60.0dB

Right:-60.0dB

FICQ:0%

NOTE: *L* for LOW (below threshold), *H* for HIGH (above threshold)

ATTENTION: Because of the SMS length limitations, only the most important parameters are included.

APPENDIX C

HOW SHOULD I CONFIGURE THE CONNECTION BETWEEN MY DEVA DEVICE AND AN FTP CLIENT?

In order for a connection to be established the following setting should be applied:

1. FTP Server Settings

The built-in FTP Server has four important parameters that should be configured: Command Port, Data Port, User name and Password. These parameters are to be used in the FTP client's connection configuration. Further information on how to change the FTP Server's settings and their respective default values can be found in the device's User manual.

WE RECOMMEND the usage of FileZilla (<https://filezilla-project.org>). This is a widespread open source software distributed free of charge, hence available for downloading from the Internet.

NOTE: The FTP Server can manage only one connection at a time. The FTP Server works in Passive mode. Hence, the FTP Client should also be set in passive mode.

2. IP Router and Port Translation Settings

If the connection to the device is made through a Network address translation (NAT) router or firewall, the port forwarding feature of the router should be configured. The port forwarding is usually set in the firewall section of the router's menu. As each router has different port forwarding procedure, we recommend you to refer to its complete manual. To allow proper data flow through the router, the FTP Command and FTP Data ports should be open.

NOTE: The FTP port numbers to be used in the port forwarding feature configuration can be found in the device.

3. Example of FTP Client (FileZilla) Settings

In some cases, FileZilla's "Quick connect" feature is not able to connect with the DEVA unit. That is why we recommend the device to be assigned in the program manually.

Enter the FTP Client and go to: **File > Site manager > New Site**. A dialog box requiring obligatory information about the device will appear. Fill in the needed information and press "OK".

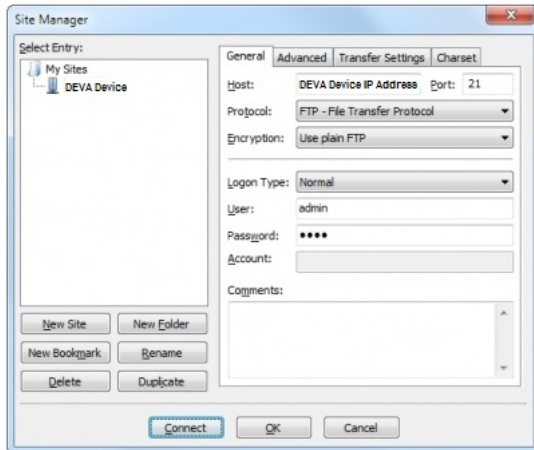

Select "Transfer Settings" sub-menu and apply the settings as shown below:

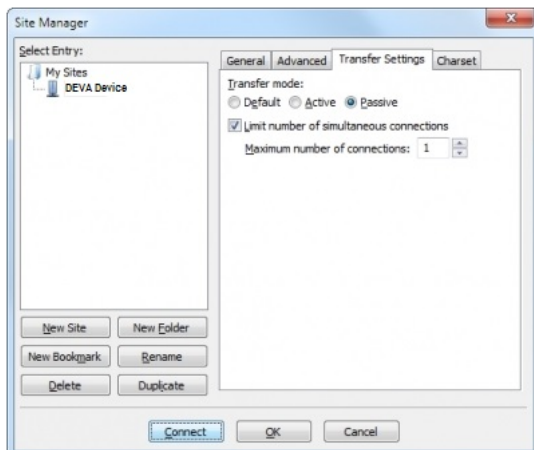

GSM MODEM OPTION - FEATURES AND USAGE

The described Features and Usage of the GSM Option is compatible with following DEVA Units:

- **DB44** – Compact FM Radio Monitoring Receiver
- **DB45** – DSP-Based FM Radio Receiver and Modulation Analyzer
- **DB4004** – DSP-based FM Radio Monitoring Receiver
- **DB4005** – SDR-Based FM Radio Modulation Analyzer and Monitoring Receiver
- **DB7000** – FM Radio Re-Broadcast Receiver with Built-in IP Audio & MP3 Backup Players
- **DB7001** – DSP-based FM Radio Re-Broadcast Receiver with TCP/IP Connectivity
- **DB7007** – Advanced FM Radio Re-Broadcast Receiver with IP Audio & MP3 Backup Players
- **DB4402-V2** – High-Performance Dual FM Monitoring Receiver & Radio Streamer

The DEVA FM Monitoring receivers supports a very wide range of GSM Modems. However, we suggest the usage of the following model - Sierra Wireless AirLink. This is the modem that is provided from DEVA Broadcast if the feature has been ordered along with the DEVA Unit.

The GSM modem model is directly PIN to PIN compatible with the DEVA Unit GSM Modem's connector, and by simply using a direct cable, you will have not any troubles with the data communication and audio insertion.

Before connecting the GSM Modem to the DEVA Unit, it is necessary to set up the parameters for normal operation. Please bear in mind that:

- GSM modem does not have an automatic detection of the baud rate (AUTOBAUD function). The most important thing is to set up the GSM Modem communication settings. The Communication speed must be 9600 bps, Data Bits: 8; Parity: None; Stop Bits:1.
- The SIM Card PIN code must be disabled in order to avoid a configuration problem of the modem. We suggest you to do this procedure using a GSM phone device of choice. This will save you a lot of time for reading the GSM Modem documentation. In case you decide to do that using the GSM Modem please refer to its User Manual for details.

IMPORTANT: Once the GSM modem is properly installed, the DEVA Unit must be pre-configured to receive messages from up to 5 authorized numbers. This can be made via the WEB interface of the DEVA Unit. Upon successful installation, a notification message will appear on the unit's LCD/OLED screen (if such is available). Using this screen you can find the best place with good GSM Network coverage for the installation of the GSM modem.

NOTE: For information, how the DEVA Unit can be accessed via the WEB Interface, please refer to the respective quick user guide for the device in question. All the documents are available at www.devabroadcast.com/downloads

SHORT MESSAGE SERVICES AVAILABLE



- By sending, a message with the command `Listen + the desired station` (for example `“Listen 101.80”`), the DEVA Unit will retrieve you a call with short record of the station that you have required.

- If you need the current information for a particular station, you can use the second command – `Status + the desired station` (for example `“Status 101.80”`). Then DEVA Unit will send you a message like the one depicted on the screen.

- The ALARM Dispatch - This is a notification that the DEVA Unit will send to you in the cases when a parameters drops below or exceeds the pre-defined threshold. In case of ALARM, the unit will send SMS to all authorized GSM numbers.

Bellow you will find examples how to use the DEVA Unit with GSM Modem features:

REMOTE AUDIO LISTENING

Type the following text and send it as SMS to the DEVA Unit’s GSM number:

`Listen FFF.FF`

`FFF.FF` is the frequency to listen to.

Upon receiving your ‘Listen’ request via SMS, the DEVA Unit will call you back and when you take the call will hear the audio on the frequency `FFF.FF`

IMPORTANT: Do not include leading zeroes such as `“Listen 089.90”`
Fill with trailing zeroes up to two digits after decimal symbol.
Decimal symbol must be ‘.’ (not comma ‘,’).
For example: `“Listen 104.50”` or `“Listen 91.55”`.

REMOTE STATUS REQUEST

The DEVA Unit can send you a report with the values of the most important FM Parameters like RF level, MPX Level, Pilot Level, RDS Level, L&R Audio Level, Stereo/Mono Status and RDS PI Code at any time. Upon receiving your request via SMS, the unit's tuner will be adjusted on the requested frequency and will make measurement of all the parameters listed above. Once the procedure is completed, an SMS message will be generated and sent to the requestor's GSM. Command Example:

```
Status FFF.FF
```

FFF.FF is frequency to Tune.

IMPORTANT: Do not include leading zeroes such as "Status 089.90"
Fill with trailing zeroes up to two digits after decimal symbol.
Decimal symbol must be '.' (not comma ',')
For example: "Status 102.55" or "Status 88.80".

The DEVA Units will shortly respond back with SMS with the following content (example):

```
STATUS:  
11.07.09 09:08:34  
FREQ:102.50MHz  
RF Level: 55.1dBuV  
MPX Level: 74.1kHz  
Left: -11.7dB  
Right: -12.3dB  
Pilot: 7.5kHz  
Stereo  
RDS Level: 4.1kHz  
PI:824D
```

INITIALIZATION PROCEDURE FOR SIERRA WIRELESS AIR-LINK FXT009 GSM MODEM

in regards with the following DEVA Units:

- **DB44** – Compact FM Radio Monitoring Receiver
- **DB45** – DSP-Based FM Radio Receiver and Modulation Analyzer
- **DB4004** – DSP-based FM Radio Monitoring Receiver
- **DB4005** – SDR-Based FM Radio Modulation Analyzer and Monitoring Receiver
- **DB7000** – FM Radio Re-Broadcast Receiver with Built-in IP Audio & MP3 Backup Players
- **DB7001** – DSP-based FM Radio Re-Broadcast Receiver with TCP/IP Connectivity
- **DB7007** – Advanced FM Radio Re-Broadcast Receiver with IP Audio & MP3 Backup Players
- **DB4402-V2** – High-Performance Dual FM Monitoring Receiver & Radio Streamer

1. Setting up the modem

Prior to connecting/using the GSM modem for the first time, kindly read the manufacturer’s user manual. The document can be found on https://source.sierrawireless.com/resources/airlink/hardware_reference_docs/airlink_fxt_series_user_guide/

The appropriate values should be assigned via the RS232 interface of the GSM modem. A custom made cable and a terminal program of any kind should be used. The cable specifications should be as follows:

To PC DB 9 female pin		GSM modem DB 15 male pin	Note
1	→	1	Data Carrier Detect
2	→	6	com TX
3	→	2	com RX
4	→	8	DTR
5	→	9	GND
6	→	7	DSR
7	→	12	RTS
8	→	11	CTS
9	→	13	RI

Next, the following settings should be applied to the terminal program:

Speed	115200 bps.
Flow control	hardware (CTS/RTS)
Parity	none
Data bits	8
Stop bits	1

To check the communication type the command “AT” in the terminal program and press Enter. The modem will/should respond with “OK”.

Upon powering on, the modem should start working with its factory settings. To see these settings type the command “AT&V”. The modem will respond with the factory default settings:

```
Q:0 V:1 S0:000 S2:043 S3:013 S4:010 S5:008
+CR:0 +CRC:0 +CMEE:0 +CBST:0,0,1
+SPEAKER:1 +ECHO:0 &C:0 &D:2 %C:0
+IPR:115200 +ICF:3,4 +IFC:2,2
```

ATTENTION: If the displayed parameters differ from one listed above, we recommend you to return the modem to its factory defaults. In order for this to happen, the command “AT&F1” should be typed.

NOTE: For further information on the AT commands, please refer to the GSM Modem complete user manual.

Once the modem is returned to its factory defaults, you can proceed with following commands:

COMMAND	DESCRIPTION	NOTE
ATE0	This command will turn Echo Off	
AT+ICF=3,4	8n1, no parity	
AT+IFC=0,0	no flow control	
AT+IPR=9600	set com speed	Change terminal speed to 9600 bps (if needed)
AT&W	save configuration	After this command turn power Off and On
AT&V	display new configuration	

NOTE: After every command, the modem should respond with “OK”.

Once all changes/modifications are applied, the modem should respond with the following adjustments:

```
Q:0 V:1 S0:000 S2:043 S3:013 S4:010 S5:008
+CR:0 +CRC:0 +CMEE:0 +CBST:0,0,1
+SPEAKER:1 +ECHO:0 &C:1 &D:2 %C:0
+IPR:9600 +ICF:3,4 +IFC:0,0
```

Upon applying all the described settings, the modem should be fully compatible for operation with DEVA Unit.

2. Connecting with DEVA Unit

Communication Cable Description:

DEVA Unit port DB 15 female pin		GSM modem DB 15 male pin	Note
2	->	2	com TX
4	->	4	mic (+)
5	->	5	mic (-)
6	->	6	com RX
9	->	9	gnd

WARRANTY TERMS AND CONDITIONS

I. TERMS OF SALE: DEVA Broadcast Ltd. products are sold with an understanding of “full satisfaction”; that is, full credit or refund will be issued for products sold as new if returned to the point of purchase within 30 days following their receipt, provided that they are returned complete and in an “as received” condition.

II. CONDITIONS OF WARRANTY: The following terms apply unless amended in writing by DEVA Broadcast Ltd.

A. The Warranty Registration Card must be completed and returned to DEVA Broadcast Ltd. within 10 days of delivery. Product registration can also be done digitally at <https://www.devabroadcast.com/members/product-registration>, after registering on our website, within 10 days of delivery.

B. This Warranty applies only to products sold “as new.” It is extended only to the original end-user and may not be transferred or assigned without prior written approval by DEVA Broadcast Ltd.

C. This Warranty does not apply to damage caused by improper mains settings and/or power supply.

D. This Warranty does not apply to damage caused by misuse, abuse, accident or neglect. This Warranty is voided by unauthorized attempts at repair or modification, or if the serial identification label has been removed or altered.

III. TERMS OF WARRANTY: DEVA Broadcast Ltd. products are warranted to be free from defects in materials and workmanship.

A. Any discrepancies noted within TWO YEARS of the date of purchase will be repaired free of charge, or the equipment will be replaced with a new or remanufactured product at DEVA Broadcast Ltd. option.

B. Parts and labor for factory repair required after the two-year Warranty period will be billed at prevailing prices and rates.

IV. RETURNING GOODS FOR FACTORY REPAIR:

A. Equipment will not be accepted for Warranty or other repair without a Return Material Authorization (RMA) number issued by DEVA Broadcast Ltd. prior to its return. An RMA number may be obtained by placing an RMA request at <https://www.devabroadcast.com/rma>. The number should be prominently marked on the outside of the shipping carton.

B. Equipment must be shipped prepaid to DEVA Broadcast Ltd. Damage sustained as a result of improper packing for return to the factory is not covered under terms of the Warranty and may occasion additional charges.

V. UPDATES TO THE TERMS OF SERVICE:

For the most up-to-date, valid, and accurate terms, conditions, and product documentation, please visit the official DEVA Broadcast Ltd. website downloads section at <https://www.devabroadcast.com/downloads/deva-documents>. Printed documents may not reflect recent amendments. Reviewing the current online versions ensures you have the latest information.



PRODUCT REGISTRATION CARD

- All fields are required, or warranty registration is invalid and void

Your Company Name _____

Contact _____

Address Line 1 _____

Address Line 2 _____

City _____

State/Province _____ ZIP/Postal Code _____

Country _____

E-mail _____ Phone _____ Fax _____

Which DEVA Broadcast Ltd. product did you purchase? _____

Product Serial # _____

Purchase date ____ / ____ / ____

Installation date ____ / ____ / ____

Your signature*

*Signing this warranty registration form you are stating that all the information provided to DEVA Broadcast Ltd. are truth and correct. DEVA Broadcast Ltd. declines any responsibility for the provided information that could result in an immediate loss of warranty for the above specified product(s).

Privacy statement: DEVA Broadcast Ltd. will not share the personal information you provide on this card with any other parties.