

MAINTENANCE AND OPERATION
INSTRUCTION MANUAL

DB2003

Remote Control
for RVR FM Radio Transmitters



Contents

Introduction	6
Typographic conventions	7
Safety Warning	8
Operating Recommendations	9
Unpacking and inspection	10
Mounting	10
<i>Rack Requirements 1U</i>	10
<i>Rack Requirements Compact Units</i>	10
<i>Stand-Alone Devices</i>	10
Getting Started	11
<i>Connection</i>	11
<i>Network Settings</i>	12
<i>Network Discovery</i>	12
<i>Network Security Recommendations</i>	13
General Information	14
Product Features	14
Technical Specification	15
Panel Indicators and Appointments	16
<i>Front Panel</i>	16
<i>Rear Panel</i>	16
Operation	17
<i>Interfaces</i>	17
<i>COM1 Connector</i>	17
<i>COM2 Connector</i>	18
<i>PC bus</i>	18
<i>Ethernet</i>	18
<i>Monitored Devices</i>	19
<i>Setting Scenario</i>	19
<i>Dayparts</i>	19
<i>Alarms</i>	20
Device Settings	21
<i>Hardware Factory Default</i>	21
<i>General Settings and Device Status</i>	22
<i>Network Settings and Status</i>	23
<i>SNMP Agent</i>	23
<i>E-mail</i>	24
<i>HTTP server and FTP server</i>	24
<i>SNTP client</i>	25
<i>GSM Modem</i>	25
<i>General-Purpose Outputs</i>	26
<i>Ping Watchdog</i>	27
<i>Device Management</i>	27
<i>Reboot Device</i>	27
<i>Restore All Except IP</i>	27
<i>Storage Format</i>	28

Firmware Update	28
Notify Power Up	28
Logs	29
Telemetry Port Settings	31
General	32
Select Model & Connect	32
Dangerous Parameters	32
Port Log	33
Dayparting	34
Alarms	35
Alarms List	35
Telemetry and Telecontrol	38
WEB Interface – Home	38
Readings	39
Telecontrol	45
Plug-in Telecontrol Parameters	45
PTX_LCD Control Parameters	47
SNMP	49
SNMP Agent	49
MIB File	50
SNMP Get & SNMP Set	52
SNMP Trap	53
APPENDIX A	54
Cables for connecting to the monitored device	54
COM1 Connector	54
COM2 Connector	54
APPENDIX B	56
Connection interfaces used with each series	56
PTX_LCD	56
PTX_DDS and PTX_LCDDSP	56
TEX_LCD and Blues	56
PJ Amplifiers	56
Plug-In series	57
APPENDIX C	58
Connection Scenarios	58
Installation with PTX-DDS on COM1 (via RS232)	59
Installation with PTX-DDS on COM2 (via RS232)	59
Installation with PTX-LCD on COM1 (via RS232)	59
Installation with PTX-LCD on COM2 (via RS232)	60
Installation with PTX-LCD on COM2 (via I ² C)	60
Installation with PTX-LCDDSP on COM1 (via RS232)	60
Installation with PTX-LCDDSP on COM2 (via RS232)	61
Installation with PJ 502/702 LCD (2HE) (via I ² C)	61
Installation with PJ 3500 LCD (3HE) (via I ² C)	62
Installation with PJ 5000 U-K (4HE) (via I ² C)	62
Installation with TEX-LCD (2HE) (via I ² C)	62
Installation with TEX-LIGHT (3HE) (via I ² C)	63
Installation with one PJ Amplifier and one Exciter (via I ² C)	64

<i>Installation with one PJ Amplifier and one Exciter (on COM1 via RS232)</i>	64
<i>Installation with one PJ Amplifier and one Exciter (on COM2 via RS232)</i>	65
<i>Installation with one PJ Amplifier and two Exciters</i>	65
<i>Installation with one PJ Amplifier and two Exciters</i>	66
<i>Installation with one PJ Amplifier and two Exciters</i>	66
<i>Installation with two PJ Amplifiers and one Exciter</i>	67
<i>Installation with three PJ Amplifiers</i>	67
<i>Installation with three Transmitters</i>	68
WARRANTY TERMS AND CONDITIONS	77
Product Registration Card	78

THIS PAGE
IS INTENTIONALLY
LEFT BLANK

Introduction

DEVA Broadcast Ltd. is an international communications and high-technology manufacturing organization, its corporate headquarters and facility located in Burgas, Bulgaria. The company serves the broadcast and corporate markets worldwide – from consumers and small businesses to the largest global organizations. It is dedicated to the research, design, development and provision of advanced products, systems and services. DEVA Broadcast launched its own brand back in 1997 and has nowadays evolved to become known as a market leader and internationally reputed manufacturer of user-friendly, cost-effective and innovative broadcast products.

Creativity and innovation are deeply woven into DEVA Broadcast corporate culture. Through successful engineering, marketing and management our team of dedicated professionals creates future-oriented solutions to improve customers' performance. You may rely that all issues communicated to our crew would be addressed accordingly. We pride ourselves on our pre and post-sales support and purchase services, which along with the outstanding quality of our radio gear have won us due respect and the market authority position.

DEVA Broadcast best-of-breed solutions have become the best sellers for our partners. The strategic partnerships which have been formed with industry leaders during all these years that we have been operating on the broadcasting market, have proved us a reliable business partner and a valuable asset, as our dealers worldwide would confirm. In constant pursuit of precision and long-term satisfaction, DEVA Broadcast enhances the reputation of our partners and clients alike. Furthermore, we have already a proven merit as a credible partner provider.

Our portfolio offers complete line of high quality and competitive products for FM and Digital Radio, Radio Networks, Telecommunication Operators and regulation authorities. For almost two decades of intensive software and hardware development, we have achieved a unique price-performance and endurance of our product lines. Our company's multitude of equipment and services is in line with the latest technologies and key trends. The most recognizable characteristics attributed to DEVA Broadcast products are their clear-cut, streamlined design, easiness of use and cost-effectiveness: simplicity of forms but multiplicity of functions.

For us there is no stage when we deem that we have reached the most satisfactory level in our work. Our engineers are in constant pursuit of new ideas and technologies to be captured in DEVA Broadcast solutions. Simultaneously, a strict control is being exercised at each step of any new development. Experience and hard work are our fundament but the continuous improving process is what we never leave aside. DEVA Broadcast participates on a regular basis in all landmark broadcasting events, not only to promote its products, but to exchange valuable know-how and experience. We are also engaged in international large-scale projects involving radio and audio solutions which makes us even more competitive on the global market.

All DEVA Broadcast products are developed and produced in accordance with the latest ISO 9001 quality control standards.

Typographic conventions

The following table describes important conventions used in the manual.

Convention and Style	Description	Examples
<i>Menu > Sub Menu > Menu Command</i>	A menu item(s) and menu command that you need to click in sequence	Click <i>Settings > General</i>
[Button]	Interface Interactive buttons	Press [OK] to save the changes
NOTE	Important notes and recommendations	NOTE: The notification will appear only once
<u>“Reference Name” on Page XXX</u>	References and links	refer to <u>“New Connection”</u> (see <u>“Monitoring” on page 56</u>)
Example	Used when example text is cited	Example for E-mail Notification: Date: 04 Nov 2013, 07:31:11

Safety Warning

ALWAYS OBSERVE THE SAFETY PRECAUTIONS.

Careful observance of the safety precautions will help prevent physical injury, damage of the equipment, and extend the equipment life.

- The servicing of electronic equipment should be performed only by qualified personnel;
- Before removing the covers the unit must be switched off and the mains cable unplugged;
- When the equipment is open, the power supply capacitors should be discharged using a suitable resistor;
- Never touch the wires or the electrical circuits;
- Use insulated tools only;
- Never touch the metal semiconductor. They might carry high voltages;
- For removing and installing electronic components, follow the recommendations for handling MOS components.
- Do not remove the factory sticker from the equipment. It contains information as regards the name, serial number and MAC address of the device.
- To join the equipment to the mains supply, use the power cord purchased with the equipment.

Operating Recommendations

To ensure normal operation of the DEVA unit, we recommend following the instructions listed below.

- Install the unit in places with good air conditioning. The unit is designed to operate within the ambient temperature range of 10 to 50°C. The equipment rack should be ventilated in order for the device to keep its internal temperature below the maximum ambient temperatures;
- We do not recommend installation in rooms with high humidity, dusty places or other aggressive conditions;
- Although the device is intended to be installed closed to exciters or transmitters, we do recommend the device to be located away from abnormally high RF fields.
- Use only checked power supply cables. We strongly recommend the usage of shielded cables;
- Connect the DEVA unit to reliable power supply sources only. In case of unstable power supply, please use Uninterruptible Power Supply (UPS);
- Use the device only with its top cover on to avoid electromagnetic anomalies. Otherwise, this may cause problems with the normal functionality of the unit;
- To ensure normal remote operation of the unit, make sure to connect the device to a good quality Internet connection;
- For the normal operation of your DEVA device, check if the network settings past through all the required data traffic.

Unpacking and inspection

Upon receipt, the equipment should be inspected for possible shipping damages. If such are found or suspected, notify the carrier at once and contact DEVA Broadcast Ltd. The original shipping carton box and packing materials should be kept for possible reuse, in case of return for Warranty repair, for example. Shipping damages as a result of improper packing for return may invalidate the Warranty!

The packing material (plastic bags, polystyrene, nails, etc.) must never be left within reach of children, as these items are potential sources of danger.

IT IS VERY IMPORTANT that the [“Product Registration Card”](#) included in the Manual be completed accurately and returned. This will assure coverage of the terms of the Warranty and it will provide a means of trace in case of lost or stolen equipment. In addition, the user will automatically receive SERVICE OR MODIFICATION INSTRUCTIONS from DEVA Broadcast Ltd.

Mounting

RACK REQUIREMENTS 1U

The unit mounts in a standard 19-inch equipment rack and requires only 1 $\frac{3}{4}$ inches (1U) of vertical rack space. In order the painted finish around the mounting holes to be protected, the use of plastic washers is recommended.

RACK REQUIREMENTS COMPACT UNITS

Our customized 1U 19-inch rack accessory provides a professional mounting option for up to three compact size DEVA units. It is made of milled aluminum and finished in black powder coat. Two extra blanking panels and set of mounting screws are provided with each rack bracket kit.

STAND-ALONE DEVICES

DEVA's stand-alone units (Radio Explorer series, BandScanner series, DVB Explorer) do not require additional tools or installation brackets.

Getting Started

In order for the normal operation of the DB2003 to be guaranteed, you will need fulfill the following conditions:

1. Standard Ethernet 10/100M connection;
2. Correctly assigned Network configuration and device settings.

To make sure that all the conditions are fulfilled please, follow the instructions below.

CONNECTION

1. Install the unit on its operation place;
2. Using the provided power cable, connect the unit to the power supply network;
3. Connect the antenna cable to the RF antenna input connector located on the rear panel of the device;
4. Connect the DB2003 to the TCP/IP network using direct network cable;
5. **IF GSM OPTION IS SUPPORTED** - Using the connection cable provided, connect the optional GSM modem. In order for better GSM network coverage to be achieved, please select proper place for the GSM antenna.

NOTE: The GSM antenna must be installed far enough from the monitoring devices. The GSM modem radiates RF signal that may cause spurious emissions that will may interfere with the accuracy of the measurements.

NETWORK SETTINGS

After connecting the network cable the Led 'LAN' located on the rear panel must be ON or flashing. The next and most important step for configuration is the adjustment procedure of the Network Communication. The settings shown below are Default Network Settings:

DHCP	Enabled
IP	Assigned by DHCP
Mask	Assigned by DHCP
Gateway	Assigned by DHCP
DNS	Assigned by DHCP
HTTP Port	80

NETWORK DISCOVERY

This is a network setting that defines whether your computer can see (find) other computers and devices on the network and whether other computers on the network can see your computer. By default, Windows Firewall blocks network discovery but you can enable it.

1. Open Advanced sharing settings by clicking the Start button, and then on "Control Panel". In the search box, type "network", click "Network and Sharing Center", and then, in the left pane click "Change advanced sharing settings";
2. Select your current network profile;
3. Click "Turn on network discovery", and then click save changes.

NOTE: If you're prompted for an administrator password or confirmation, type the password, provide confirmation or contact your system administrator.

If you have already enabled this function on your computer DB2003 will be automatically added to the Device list section. The device will be ready for usage and no additional adjustments will be required except user name and password.

NOTE: If the port is different than the default one (80), it is necessary to specify it, for example:
`http://192.168.1.2:9000`

ATTENTION: Depending on Internet Protocol Settings, the assigned IP address may not be visible outside your local network, thus the device may be accessed only within that network. Consult with your network administrator for the appropriate IP settings.

NETWORK SECURITY RECOMMENDATIONS

1. It is not recommended the DB2003 to be directly connected to the Internet. This may lead to unregulated access and/or problematic operation of the device. To ensure secure connection, we recommend the device to be installed behind a router with an active firewall.
2. If remote access to the device is needed, we recommend using VPN to the router or the port of the relevant service (WEB, SNMP, Application, etc.) to be properly NAT forwarded.
3. If NAT forward is used, it is highly recommended random ports of your choice to be used. Not the standard ones (80 for WEB, 161 for SNMP, etc.).
4. Using DMZ connection is not recommended.
5. Make sure to change the standard access credentials (usernames and passwords, SNMP communities).

For detailed information as regards the recommendations listed above or need of further instructions, please contact your network administrator.

General Information

DB2003 is an advanced SNMP V.2 telemetry tool all in a class of its own. Specifically developed to guarantee easy and flexible real-time monitoring and remote control options for RVR FM Radio Transmitters, this product brings efficiency and reliability coupled with a compact and practical design. It provides IP-based broadcast control for exceptional scalability, gives you access to a large number of devices and supports a variety of transmitter configurations: Modular, KPS, TEX, PTX, and BARRACUDA as a single or dual drive, as well as a 1+1 and an N+1 configuration. A quick intervention by the competent staff in the event of a fault has never been so easy, with adjustable alarm thresholds for all important parameters and alarms dispatched via E-mail, SMS and SNMP.

Top product performance is also achieved thanks to the LAN port for full TCP/IP remote control and monitoring and the extremely intuitive embedded WEB server for interactive supervision. What is more, status report via SMS is available as well with the optional GSM Modem. DB2003 also provides a number of great additional features, such as the Factory Parameters Restore option, SNTP for automatic synchronization of the built-in clock, as well as date and time settings in various formats. It allows for easy firmware upgrades to ensure that your remote control device is always up to date.

Combined with a compact and robust aluminum case, this powerful product delivers dependable round-the-clock operation with guaranteed quality.

Product Features

- IP-based broadcast control for exceptional scalability
- LAN port for full TCP/IP remote control and monitoring
- Very Intuitive Embedded WEB server for interactive supervision
- Advanced monitoring and full control by SNMP Ver.2C
- Adjustable alarms thresholds for all important parameters
- Firmware update for future-proof operation
- Parameters Factory Restore Option
- Alarm dispatch via E-mail, SMS, SNMP
- Proved and reliable hardware for 24/7/365 operating
- Status reporting via SMS with optional GSM Modem
- Attractive price and very good price-performance ratio
- SNTP for automatic synchronization of the built-in clock
- Date & Time Settings with various formats
- Compact and Robust Aluminum Case for high RF immunity
- Easy Installation and Setup

Technical Specification

USER INTERFACE	
WEB interface	Full monitoring and control; Interactive and easy to use
Indicators	6 LEDs on front panel
COMMUNICATION INTERFACES	
Ethernet 10/100 Base-T	RJ45 connector
RS232	2 interfaces
RS485	1 interface
I ² C	1 bus
Protocols	HTTP, SNMP, SMTP, FTP, DHCP
MEASUREMENT STORAGE	
Storage	8GB Build-in Memory Card
Data format	Text, CSV
OTHER	
GPO	3 outputs, Open Collector type
GSM modem	Support generic external GSM modem to send SMS as alarm notification
OPERATING CONDITIONS	
Temperature	-15°C to 55°C
Humidity	< 95%, non-condensing
Altitude	0 to 5000m above sea level
EMC Immunity	6V/m
POWER	
Voltage	External, 12V/1A
Power consumption	12 VA
Connector	Power jack 5.5 mm
SIZE AND WEIGHT	
Dimensions (W,H,D)	125 x 31 x 160 mm
Shipping size and weight	270 x 54 x 230 mm / 1.1kg

Panel Indicators and Appointments

FRONT PANEL

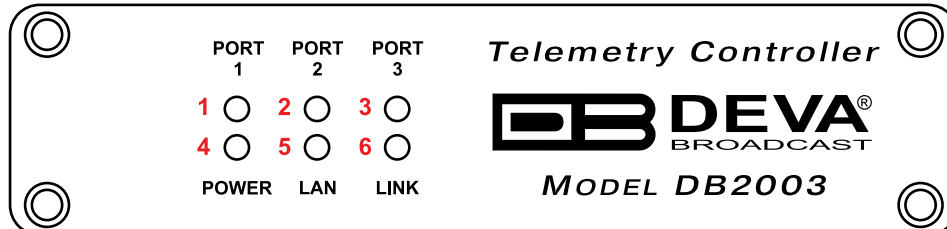

1. Telemetry PORT 1 LED Activity Indicator;
2. Telemetry PORT 2 LED Activity Indicator;
3. Telemetry PORT 3 LED Activity Indicator;
4. Power LED Indicator;
5. LAN Presence LED Indicator;
6. LINK LED Indicator - This LED can be in one of the following states:
 - Off – No User Connected;
 - On – User is connected;

REAR PANEL

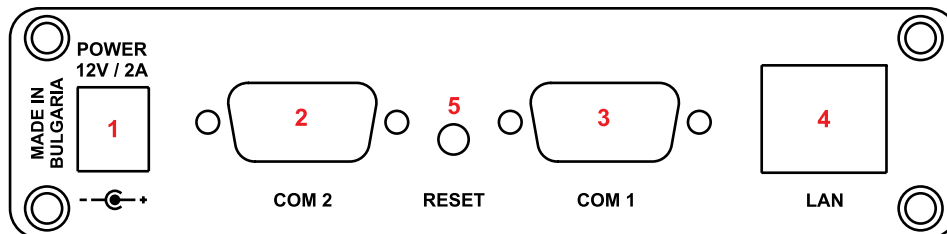

1. Power Supply (12V, 2A);
2. COM 2 Connector - DB15 High Density male;
3. COM 1 Connector - DB9 male;
4. LAN Port / Internet Input – standard RJ-45 port;
5. Factory Defaults reset button

Operation

DB2003 has three logical Telemetry Ports – Telemetry Port 1, Telemetry Port 2 and Telemetry Port 3. Each Telemetry Port can connect to the monitored device via one of several available physical interfaces.

INTERFACES

DB2003 has two connectors to the monitored device - COM1 and COM2. The COM1 connector supports RS232 interface only. The COM2 connector is multi-functional, supporting I²C, RS232, RS485 half-duplex interfaces, as well as GPO1, GPO2 and GPO3.

COM1 Connector

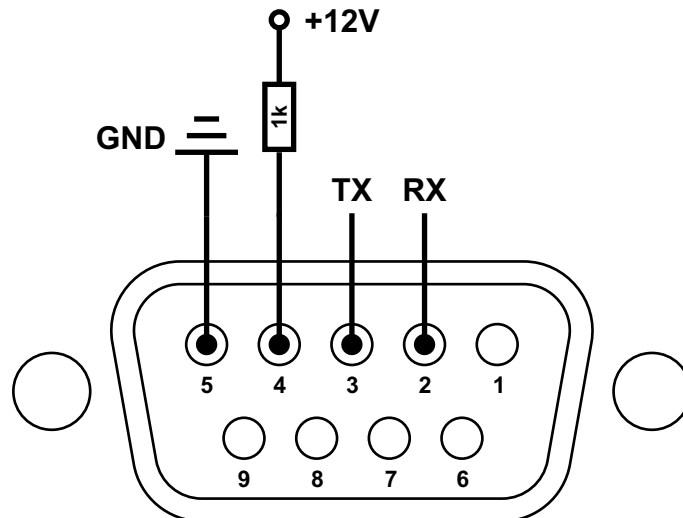

This is a DB9 connector.

- Pin 1 – not used
- Pin 2 – RS232 Rx line (DB2003 receiver)
- Pin 3 – RS232 Tx line (DB2003 transmitter)
- Pin 4 – output +12V – can be used to switch Plug-in Control Unit interface on front panel connector
- Pin 5 – common ground
- Pin 6 to 9 – not used

COM2 Connector

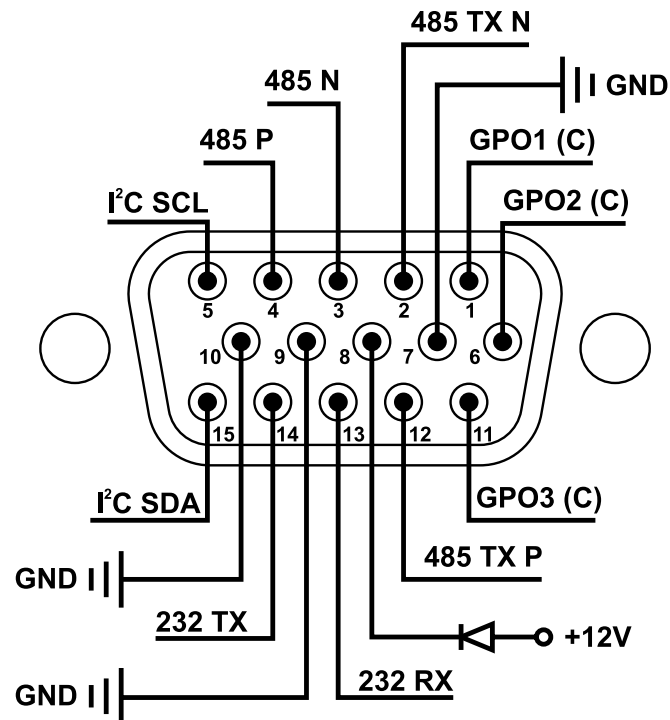

This is a DB15 high-density connector.

- Pin 1 – GPO1 (open collector)
- Pin 2 – RS485 full-duplex TX Neg
- Pin 3 – RS485 half-duplex Neg
- Pin 4 – RS485 half-duplex Pos
- Pin 5 – I²C bus SCL line
- Pin 6 – GPO2 (open collector)
- Pin 7 – Common Ground
- Pin 8 – Output +12V
- Pin 9, Pin 10 – Common Ground
- Pin 11 – GPO3 (open collector)
- Pin 12 – RS485 full-duplex TX Pos
- Pin 13 –RS232 RX line (DB2003 Receiver)
- Pin 14 –RS232 TX line (DB2003 Transmitter)
- Pin 15 – I²C bus SDA line

I²C bus

I²C bus is independent – it only uses pins on the COM2 connector. Several monitored devices (telemetry ports) can be connected, with different bus addresses assigned to them. This is 5V bus.

Ethernet

DB2003 comes with an RJ45 connector for an Ethernet Internet connection. The main interaction between man and machine is through the WEB-based interface. Through a WEB browser, the device can be accessed, monitored and set up from your computer, tablet or smartphone.

MONITORED DEVICES

DB2003 can be used with the following RVR Elettronica devices:

- Transmitter/Exciter series: PTX_LCD, PTX_DDS, PTX_LCD_DSP, TEX_LCD and Blues;
- Power Amplifiers: PJ, Plug-in KPS-CA and Barracuda;
- Change-over Units.

The monitored device must be connected through a cable to the DB2003, with the relevant Telemetry Port set up as specified in the [“Telemetry Port Settings” on page 31](#).

You will find details on the cables for connecting the DB2003 to the monitored device in [“APPENDIX A” on page 54](#).

SETTING SCENARIO

DB2003 has several communication interfaces: 2x RS232, RS485 half duplex and I²C.

DB2003 has three Telemetry Ports. Each Telemetry Port can use any of the available interfaces to connect to its corresponding monitored device. Multiple scenarios are possible, with the monitored devices not exceeding 3 (the number of Telemetry Ports).

Some monitored devices can be connected via RS232 and/or I²C (PTX_LCD). Plug-in KPS-CA can be connected via RS485 or RS232, but the preferred interface is RS485, so RS232 can be available to service the transmitter.

In accordance with their installation, the client must make the necessary cables. Details on Cables and connectors can be found in [“APPENDIX A” on page 54](#).

DB2003 is able to send alarm notifications via SMS using a GSM modem, which is purchased additionally. The Modem is connected to communication port “COM1” and upon activating it, that port cannot be used to connect to a monitored device.

Depending on the selected operation mode, the DB2003 can be used for:

- passive monitoring of the monitored device, without affecting it;
- remote control of the monitored device through commands sent by an operator;
- automatic control of the monitored device by a set schedule – change of power.

DAYPARTS

DB2003 allows users to set up a weekly schedule to manage the power of the monitored device. Not all monitored device series can be managed. This functionality is available for PTX_LCD, PTX_LCDDSP, PTX_DDS, TEX_LCD, Blues, Plug-in KPS-CA and Barracuda.

Users can set two levels – Low Power and Full Power. When there is an active Daypart, a command is sent to manage the power level to Low Power. When there is no active Daypart, a command is sent to manage the power level to Full Power.

Further details on the setup and use of Dayparts are available in [“Dayparting” on page 34](#).

ALARMS

DB2003 allows you to set a value threshold for some of the monitored signals. If a value stays beyond that threshold for a certain amount of time, an alarm event notification is sent.

The notification can be made in one way or in a combination of ways: E-mail, SNMP trap, SMS or GPO activation.

For some signals, it is possible to monitor high and low threshold, e.g. Forward Power and Temperature. For other signals, such as Reflected Power, only the upper threshold can be monitored. A notification is sent both when the signal goes beyond the threshold (alarm activation), and when normal values are restored (idle).

An alarm notification is also sent when there is an event such as loss of connection with the monitored device. No threshold or time delay is set for this alarm type. For some events, a notification is not necessary for a signal's return to normal status, e.g. in the case of power change.

Depending on the monitored device series, the number and type of alarms available will also change. Logging on as **admin** allows you to select which ones to activate and at what thresholds.

Further details on the setup and use of Alarms are available in [“Alarms” on page 35](#).

Device Settings

This chapter lists the settings influencing the operation of the DB2003 but having no direct influence on the monitored device, as well as its selection and connection.

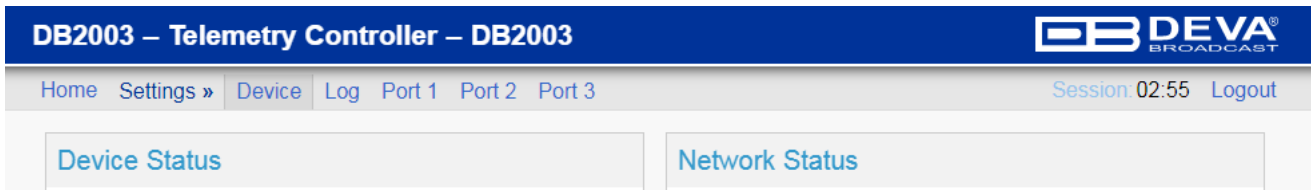

There are two levels of login rights to the DB2003: as **admin** or as **user**. These are default usernames, which can be changed. Each of them has its own password for access. Admin has full access to the device and can remotely manage the monitored devices. The session is maximum 10 minutes long (subject to setup) and can be renewed. The admin session can be interrupted by an SNMP user for a set operation.

User has limited rights. It can monitor but can not edit. It has no access to settings and cannot change the operation mode of the DB2003 or influence monitored devices. Its session can be set to no time limits but can be interrupted by admin or by an SNMP user for a set operation.

HARDWARE FACTORY DEFAULT

It is recommended that the device should have no cables and power supply connected. Press and hold the RESET button (between COM1 and COM2). Then feed power to the device, with the button held pressed for at least 5 seconds, until all LED's on the lower row start blinking simultaneously. Release the button and wait for a few seconds until the process is completed and the PWR LED is on.

This procedure restores all settings to their factory defaults, including the device's IP address. DHCP is on. Logs are not deleted.

GENERAL SETTINGS AND DEVICE STATUS

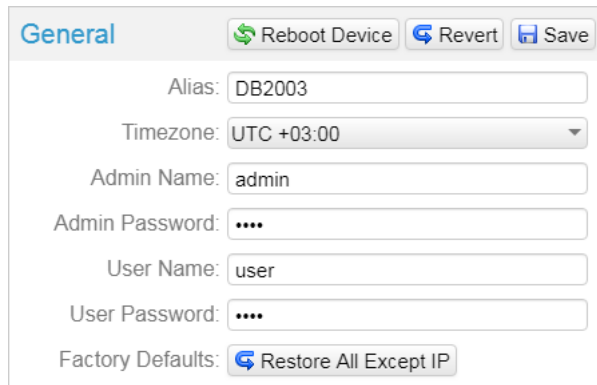

Alias – helps the user recognize the device.

Timezone – setting the correct value will allow automatic setting of DB2003’s time in accordance with its location.

Admin Name and **Admin Password** – Admin access credentials. Default values are *admin* and *pass*.

User Name and **User Password** – access credentials with user rights. Default values are *user* and *pass*.

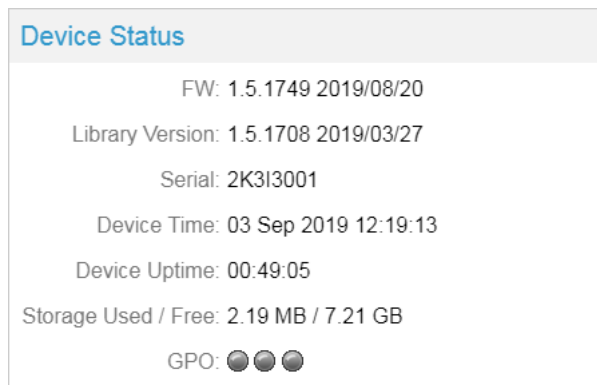

The Device Status section provides information about the current status of the device – firmware version, serial number, current device time, used and free internal storage space, GPO status.

NETWORK SETTINGS AND STATUS

Network	Network Status
DHCP: <input type="radio"/> Disable <input checked="" type="radio"/> Enable	MAC: 00:04:A3:56:EE:BB
IP Type: Assigned by DHCP	IP Type: Assigned by DHCP
IP: <input type="text" value="192.168.1.2"/>	IP: 192.168.20.200
Network Mask: <input type="text" value="255.255.255.0"/>	Network Mask: 255.255.255.0
Gateway: <input type="text" value="192.168.1.1"/>	Gateway: 192.168.20.1
Primary DNS: <input type="text" value="192.168.1.1"/>	Primary DNS: 192.168.20.5
Secondary DNS: <input type="text" value="192.168.1.1"/>	Secondary DNS: 0.0.0.0

This section contains information about IP Address and assignment type, DHCP enable/disable, network mask, gateway, primary and secondary DNS, MAC address.

SNMP AGENT

SNMP Agent
SNMP: <input type="radio"/> Disable <input checked="" type="radio"/> Enable
Agent Port: <input type="text" value="161"/>
Session Timeout: <input type="text" value="00:10"/> m:s
Read Community: <input type="text" value="DB2003"/>
Write Community: <input type="text" value="DB2003"/>
Agent ID: <input type="text" value="0"/>
Manager IP: <input type="text" value="192.168.1.1"/>
Manager Port: <input type="text" value="162"/>
SNMP Test: <input type="button" value="⚡ Test Trap"/>
SNMP MIB File: <input type="button" value="↓ Download"/>

The SNMP Agent section allows you to Enable/Disable agent, change agent and manager ports and set manager address (SNMP trap receiver). The DB2003 uses SNMP version 2 – the Read/Write community is similar to a password for read/write access. Use the agent ID to distinguish between multiple agents in one trap receiver.

You can download the MIB file as well as test the entire route from end to end.

E-MAIL

E-mail configuration interface showing fields for Email (SMTP, DEVA, Disabled), Connection Type (Regular), Email Address 1, Email Address 2, Mail Server, Server Port (25), Sender Name, User Name, User Password, and Host name (DB2003_SMTTP_CLIENT). Buttons for Revert and Save are visible.

To receive alarm event notifications by email, you must specify the receiver's address. You can set one or two receiver addresses.

In order for the notifications to be received, the DB2003 requires an email server to re-direct them. There are two options here:

1. You can use the address of a server you are using;
2. You can use a server provided by DEVA for the purpose .

PLEASE NOTE that notifications may be filtered as spam and may not reach the receiver.

HTTP SERVER AND FTP SERVER

FTP Server configuration interface showing FTP (Disable, Enable), Command Port (21), and Data Port (2020). Buttons for Revert and Save are visible.

HTTP Server configuration interface showing HTTP (Disable, Enable), Port (80), Admin Session (03:00 m:s), and User Session (03:00 m:s). Buttons for Revert and Save are visible.

When the HTTP server is disabled, access via WEB browser is no longer possible. However, users can still have access via SNMP. It is possible to change the default port – when there are several devices with the same external IP address.

Here, you can also set the duration of the admin session. When that time elapses, and the device is not being actively used, the session is automatically terminated to allow access to user. It is recommended that you log out.

When setting zero duration for the user session, it becomes unlimited. It may be interrupted upon access request by admin or by an SNMP set operation.

SNTP CLIENT

SNTP Internet Time Revert Save

SNTP: Disable Enable

Time Server:

Server Port:

It is recommended that this service should remain enabled, so the DB2003 can automatically set its time. That ensures that the time in the system and port logs is accurate.

You can also specify another time server.

GSM MODEM

GSM Modem Status: Active Test Revert Save

GSM Modem: to COM1 Disabled

Baudrate:

Operator: M-TEL GSM BG

Signal: 

BER: 

Number 1:

Number 2:

Number 3:

Number 4:

Number 5:

To receive an SMS as an alarm notification, you must connect a GSM Modem to the DB2003. The modem has to have an active SIM card, with the PIN code protection disabled. Set the GSM Modem to COM1 to enable communication. If there are no issues, Status must become Active, as illustrated above.

In the right-hand section, set the phone numbers of up to 5 message receivers. Use the [Test] button to make sure all of them receive the notifications.

When selector “GSM Modem” is set “to COM1”, even if there is no connected modem, communication port COM1 is not available and cannot be used to connect to the monitored device.

GENERAL-PURPOSE OUTPUTS

General-Purpose Outputs

Revert Save

GPO 1 Status: Pulse
Function: Alarm Output
Type: Level Act
Pulse Duration: 5.0 s
Alias: gpo1 name

GPO 2 Status: Pulse
Function: WDog Output
Type: Pulse Act
Pulse Duration: 3.0 s
Alias: gpo2 name

GPO 3 Status: Pulse
Function: Manual Control
Type: Pulse Act
Pulse Duration: 5.0 s
Alias: gpo3 name

DB2003 has three general purpose outputs: GPO1, GPO2 and GPO3. They have identical functionality and are hereinafter to be referred to as GPO's. Each GPO is the TLV817 optocoupler photo transistor collector (NPN transistor, $V_{ce} = 30V$ max, $I_c = 20mA$ max). Each of the three emitters is connected to common ground. It may be seen as a normally open contact. A Pinout is shown in ["COM2 Connector" on page 18](#).

You can set an appropriate alias for each GPO as a reminder of what it controls.

In accordance with its function, each GPO can be controlled by an alarm event, by ping watchdog or manually. You can select whether an alarm event will cause opening or closing of the contact. **PLEASE NOTE** that without a power supply, the GPO is normally open, which can be interpreted as a false alarm.

With manual control or ping watchdog, you can select a stable status change or a change for a certain amount of time (Pulse Duration).

In order for a GPO to be used as an alarm event output, the following three conditions must be fulfilled:

1. The Alarm Output function must be selected;
2. In the Telemetry Port/Alarms setting, the Enabled option must be selected for GPO;
3. The GPO must be indicated in Notifications/GPO. Further details on alarms are available in ["Alarms" on page 35](#).

In order for the GPO to be used as a ping watchdog output, you must select the relevant output function and specify in the ping watchdog setting which GPO must be used.

For manual control of the GPO, select the relevant function. Set the required output status. You can select a pulse type and start a pulse with the set duration. **PLEASE NOTE** that without a power supply, the GPO is normally open, which can be interpreted as a false activation.

PING WATCHDOG

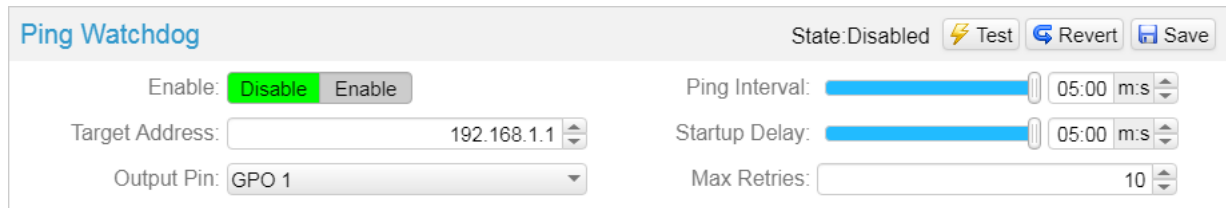

You must enter an address to which the DB2003 must send a ping at certain intervals. When the set number of unsuccessful attempts is reached, the selected GPO is activated. A GPO is generally of the pulse type and cuts the power supply to the controlled device, causing a reboot.

Startup Delay sets the time for the controlled device to reboot, during which no ping is sent.

With the [Test] button, users can check the routing to the specified address.

DEVICE MANAGEMENT

Reboot Device

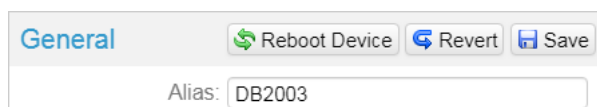

[Reboot Device] causes the device (DB2003) to re-start. It does not change the settings or delete the logs. If Dayparting has been activated for any Telemetry Port, a command will be sent to the monitored device to determine the forward power in accordance with the current time.

Restore All Except IP



[Restore All Except IP] causes all settings to be restored to their default values. It does not affect the IP address settings, so it is still possible to connect to the device. The Timezone setting is not changed. Logs are not deleted.

No commands are sent to the monitored devices. All Telemetry Ports are disabled, selected models and parameters for connecting to the monitored devices are canceled.

RECOMMENDATION: Prior to taking this action, make sure you have all the data required for restoring the connection to the monitored devices – interface, speed, address, model, etc.

Storage Format

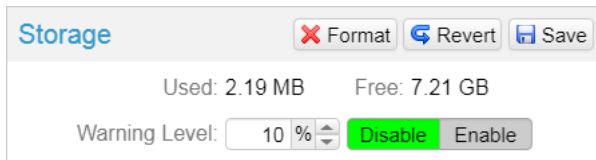

Storage Format is where you can format the internal storage. All logs are deleted. It does not affect the settings regarding the connection with monitored devices. No additional commands are sent to the monitored devices.

When “Warning Level” is **Enabled** and **Used** exceeds the set level, a message is shown:

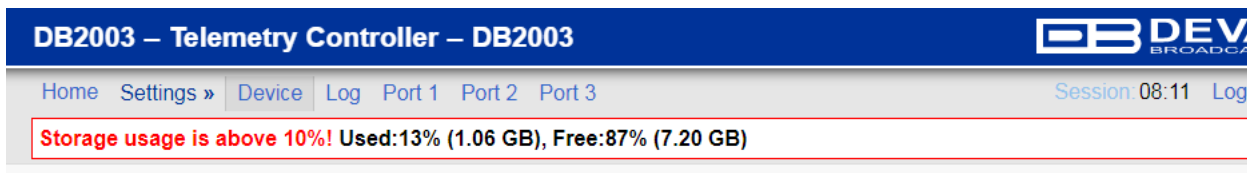

The message disappears when “Warning Level” is **Disabled** or when the set level exceeds the used one:

- Warning Level increases;
- Memory is freed by removing old files – use FTP client;
- [Format] – deletes ALL files – System and Port LOGs.

Firmware Update



Firmware Update installs an updated DB2003 firmware version. Unless there are explicit instructions accompanying the firmware, it does not cause or require change in any of the settings. It does not delete the logs. If Dayparting has been activated for any Telemetry Port, a command will be sent to the monitored device to determine the forward power in accordance with the current time.

Notify Power Up

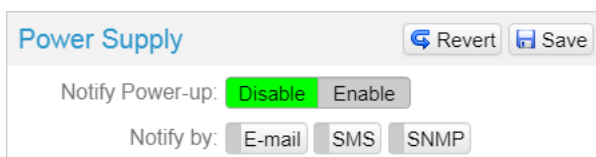

If you **Enable** the respective notification channel (Email, SMS, SNMP trap), you will receive a notification once DB2003 boots up. For that to happen, settings for the notification channel must be applied.

LOGS

DB2003 creates two types of logs – **System Log** and **Port Logs**. The System Log can be read via the WEB interface.

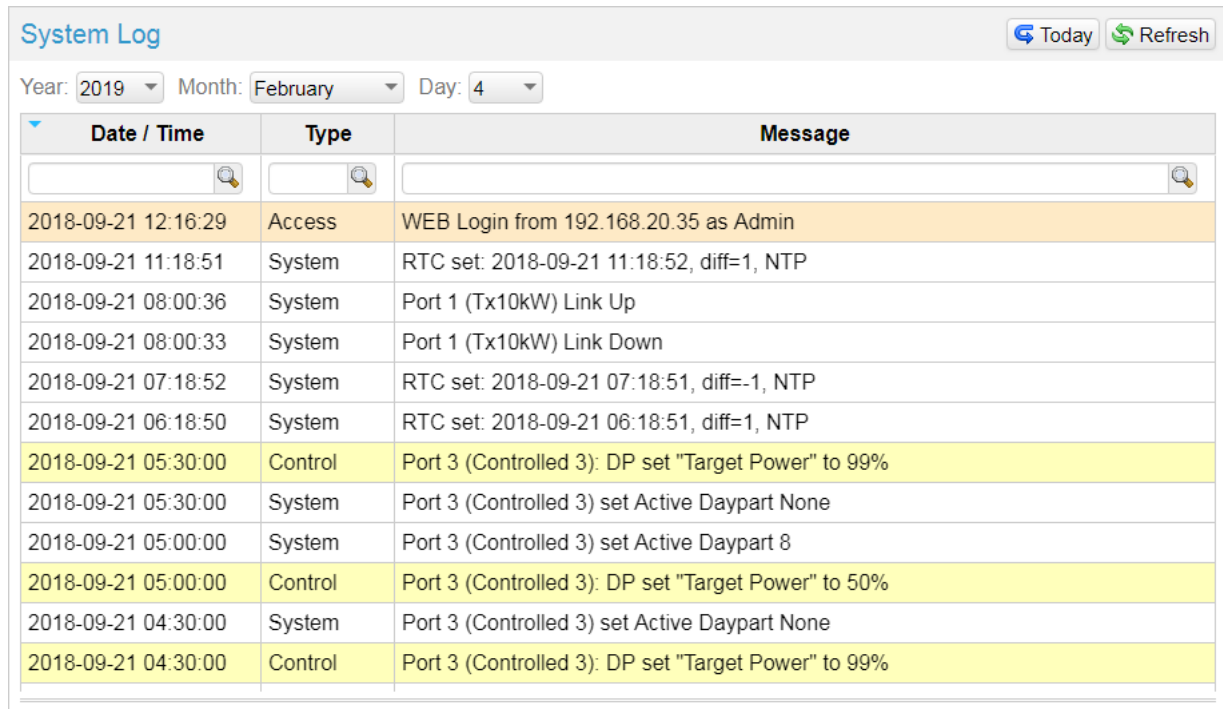

Date / Time	Type	Message
2018-09-21 12:16:29	Access	WEB Login from 192.168.20.35 as Admin
2018-09-21 11:18:51	System	RTC set: 2018-09-21 11:18:52, diff=1, NTP
2018-09-21 08:00:36	System	Port 1 (Tx10kW) Link Up
2018-09-21 08:00:33	System	Port 1 (Tx10kW) Link Down
2018-09-21 07:18:52	System	RTC set: 2018-09-21 07:18:51, diff=-1, NTP
2018-09-21 06:18:50	System	RTC set: 2018-09-21 06:18:51, diff=1, NTP
2018-09-21 05:30:00	Control	Port 3 (Controlled 3): DP set "Target Power" to 99%
2018-09-21 05:30:00	System	Port 3 (Controlled 3) set Active Daypart None
2018-09-21 05:00:00	System	Port 3 (Controlled 3) set Active Daypart 8
2018-09-21 05:00:00	Control	Port 3 (Controlled 3): DP set "Target Power" to 50%
2018-09-21 04:30:00	System	Port 3 (Controlled 3) set Active Daypart None
2018-09-21 04:30:00	Control	Port 3 (Controlled 3): DP set "Target Power" to 99%

Select the desired date, **Month**, **Year** and see the Log for the respective day. With “All”, you can select for **Day** all the days of the **Month**; if a great deal of information has been stored, please allow for a certain delay. To quickly switch back to today’s log, use the [Today] button.

Log can be sorted by column: **Data/Time**, **Type** or **Message** – in descending or ascending order. There are filters to select only the required information – for a specific time, type of log, port or certain events.

Recording data in the **System Log** cannot be disabled. The System Log does not record the values of the signals read from the monitored devices. The files can also be accessed via FTP at “sys”.

To record data in the **Port Logs**, this must be allowed with the relevant Telemetry Port setting ([see “Telemetry Port Settings” on page 31](#)). Users must set the required interval for recording the data read from the monitored device. It is recommended that a short interval (in seconds) should be set at only one port, for a limited time. Especially in the case of a monitored Plug-in, the size of **Port Logs** is too large, which makes working with them more difficult. The **Port Log** data is extracted from the DB2003 and visualized in the appropriate way through specialized software.

Message type (where 'N' – 1, 2 or 3 – Telemetry Port number):

- system:
 - = Device is powered up;
 - = Storage init OK;
 - = RTC set: 2018-05-28 16:04:44, diff=-1, NTP;
 - = Port N Link Up/Down;
 - = Port N Enabled/Disabled;
 - = Port N "Dayparting" is Enabled/Disabled;
 - = Port N set Active Daypart None/1/2/...8;
 - = Port N "Edit Dangerous Parameters": Timer expired - Disable!
- access:
 - = WEB login/logout;
 - = SNMP login/logout;
- management:
 - = Device setup;
 - = Port N setup;
 - = SysLog Cleared!
 - = Storage Formated!
- control - impact of the monitored device:
 - = Port N actions
- alarm - notice that the value of a monitored signal passes a set threshold;
- inf - setup information, **Port Log** only;
- log - monitored signal values, **Port Log** only;
- cat - catalog - substitution of signal names and units of measurement, **Port Log** only.

Telemetry Port Settings

The settings for each port are identical. This Guide is to designate each port with the phrase Telemetry Port. The Dayparting function is not available for all monitored device series and may therefore not be displayed on the settings screen. The number and type of alarm events is different for each series and may differ from the ones described below.

The screenshot displays the web interface for the DB2003 Telemetry Controller. The top navigation bar includes 'Home', 'Settings', 'Device', 'Log', 'Port 1', 'Port 2', and 'Port 3'. The current session is 02:18, and there is a 'Logout' option. The main content area is titled 'Telemetry Port 1 - General' and includes a 'Revert' and 'Save' button. The status bar shows 'State: Run', 'Alias: Tx10kW', and 'Model: TX 3 KPS-CA'. The settings are organized into two columns:

Telemetry Port: <input type="radio"/> Disable <input checked="" type="radio"/> Enable	Alias: <input type="text" value="Tx10kW"/>
Interface: <input type="text" value="Com port 2 as RS485 half duplex"/>	Serie: <input type="text" value="Plug-in KPS-CA (air cooled)"/>
Bus speed: <input type="text" value="115200"/>	Model: <input type="text" value="TX 3 KPS-CA"/>
Bus address: <input type="text" value="18"/>	Logger: <input type="text" value="Every 1 minute"/>
Edit Dangerous Parameters: <input type="text" value="Disable"/>	

Below the general settings are two expandable sections: 'Telemetry Port 1 - Dayparts' and 'Telemetry Port 1 - Alarms'. Each section has a 'Graph', 'Revert', and 'Save' button. The 'Alarms' section also includes a 'Reset All Alarms' button.

GENERAL

In this group of settings, you have to specify the device the DB2003 is to monitor/control and how to connect to it. Setting an **Alias** allows the user to recognize the different monitored devices. This is where you enable/disable the port.

Select Model & Connect

The set interface must match the one which is physically connected. The address and speed of the connection must correspond to the ones set in the monitored device. With the I²C interface, speed is not taken into consideration.

With different interfaces, the address can be the same for several ports, but when the connection is over I²C, different addresses must be set to differentiate between devices. If required, set another address into the monitored device.

The models in the PTX_LCD, PTX_DDS, PTX_LCDDSP, TEX_LCD and Blues series have different nominal forward power. If you select another model from the same series, which is different from the one actually connected, the DB2003 will not be able to tell the difference. The power in W when setting alarm and dayparts thresholds will be calculated against the nominal power of the set model. For alarms, power is compared in W, while for Target Power command values are in percent. That will lead to a difference between the transmitter's power and the power expected by the DB2003.

The models from the Plug-in KPS-CA and Barracuda series differ by the number of RF Units. When a model is set, which is different from the one actually connected, the DB2003 will not display the data from all RF units or will try to request and display data from non-existent RF units.

It is highly recommended that you set a model precisely as the one connected.

Dangerous Parameters

Telemetry Port 1 - General

State: ● Run Alias: Tx10kW Model: TX 3 KPS-CA

Telemetry Port: Disable Enable

Interface: Com port 2 as RS485 half duplex

Bus speed: 115200 Bus address: 18

Edit Dangerous Parameters: Disable
Disable
Enable
For a limited time

The change in some parameters is dangerous, e.g. the change in the transmitter's frequency. The DB2003 has a designated mechanism to limit such actions, therefore the default Edit Dangerous Parameters value is Disable. In this case, the dangerous parameters are not available for telecontrol. When the selected value is Enable, the dangerous parameters are displayed and can be edited. They are marked by a warning sign.

When you have selected the value "**For a limited time**", you see a ticker counting seconds down - this is the time in which the new value must be entered and saved. This mechanism presupposes awareness of whether the operator's actions are necessary.

Port Log

Revert Save

Alias: Tx10kW

Serie: Plug-in KPS-CA (air cooled)

Model: TX 3 KPS-CA

Logger: Every 1 minute

- Disable
- Every 10 seconds
- Every 20 seconds
- Every 30 seconds
- Every 1 minute
- Every 2 minutes
- Every 5 minutes
- Every 10 minutes

With this setting, you can disable or enable the recording of a log for the respective port, and choose the required logger interval for recording data from the monitored device. The port logs data is extracted from the DB2003 and visualized in an appropriate way via specialized software. In order for the software to work, the FTP server of the DB2003 must be enabled.

It is recommended that a short interval (in seconds) should be set at only one port, for a limited time. Especially in the case of a monitored Plug-in, the size of port logs is too large, which makes working with them more difficult.

DAYPARTING

DB2003 allows users to create a weekly schedule to control the power of the monitored device. Not all series of monitored devices can be managed in this way. The functionality is available for PTX_LCD, PTX_DDS, PTX_LCDDSP, TEX_LCD, Blues, Plug-in KPS-CA and Barracuda.

Two levels are set, called Low Power and Full Power. When there is an active Daypart, a command is sent to control the power to Low Power. When there is no active Daypart, a command is sent to control the power to Full Power.

There are 8 Dayparts selectors with identical parameters. It is possible to set overlapping values; it is sufficient for one Daypart to be active to set Low Power.

To set values for Low Power and Full Power, the relevant value is in percent. The value in W is calculated against the nominal power for the selected monitored device model. The Plug-in and Barracuda series allow you to set Target Power up to 105%, while PTX, TEX and Blues – up to 100%.

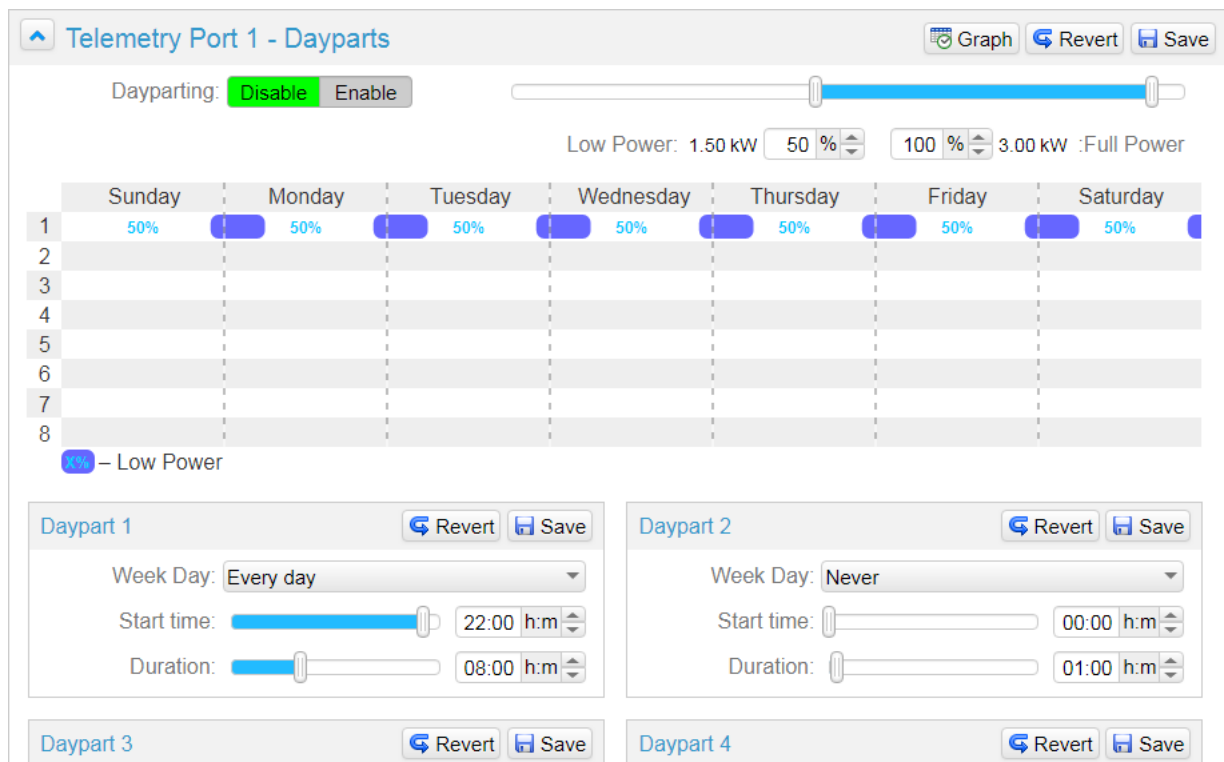

When Dayparts are enabled, the setting of Forward Power is controlled by the DB2003 and the relevant parameters are not available for telecontrol – Target Power for PTX, TEX and Blues, and Selected Power for Plug-in: Nominal/Lower and the Nominal and Lower values. For the PTX, TEX and Blues models, the DB2003 monitors and controls the Target Power parameter. For the Plug-in models, respectively Nominal or Lower Power is selected via Selected Power, while at the same time the values of the two levels must match the ones set in Dayparts. The DB2003 sends commands to control the power but does not change the On-Air status.

For each Daypart, users must set the day of the week when it must be active. Selecting Never disables the respective Daypart. Selecting Every Day ensures Daypart is active for the specified time frame, regardless of the current day.

The active time frame is defined by its **Start time** and **Duration**.

ALARMS

DB2003 allows you to set a threshold for the values of some of the monitored signals. When the threshold is passed and this continues for a certain amount of time, an alarm event notification is sent.

The notification can be made in one way or in a combination of ways: E-mail, SNMP trap, SMS or GPO activation. You must Enable/Disable the respective notification method for all Telemetry Port alarms. That way, you can disable all alarms for this particular Telemetry Port. For each alarm, the notification method is selected individually.

Alarms List

Alarm Name	Notification	Series						
		PTX	TEX	Blues	Plug-in	PJ	SCML	HC
Forward Power (FWD)	Low, High, Idle	✓	✓	✓	✓	✓	✓	✓
Reflected Power (RFL)	High, Idle	✓	✓	✓	✓	✓	✓	✓
Unbalanced Power (UNB)	High, Idle				✓			✓
Temperature (t°)	Low, High, Idle	✓	✓	✓	✓	✓	✓	✓
Total Modulation (MOD)	Low, High, Idle	✓	✓	✓				
PLL Lock Loss (PLL)	Active, Idle	✓	✓	✓				
Audio Loss (AUD)	Active, Idle	✓	✓	✓				
SWR Alarm (SWR)	Active, Idle	✓	✓	✓				
General Alarm (GEN)	Active, Idle	✓						
Foldback (FOLD)	Active, Idle		✓	✓				
Local Control (LOC)	Active, Idle				✓			
Log Changed (LOG)	Active				✓			
Target Changed (TGT)	Active				✓			
Front Panel Access (ACC)	Active	✓	✓	✓				
Link Loss (LNK)	Active, Idle	✓	✓	✓	✓	✓	✓	✓

This table shows which levels are monitored for the respective signals, as well as the available alarms depending on the model of the monitored device. Admin can choose which ones to enable and at what thresholds. With the Reset button, you return the counter and the timer of the respective alarm to zero.

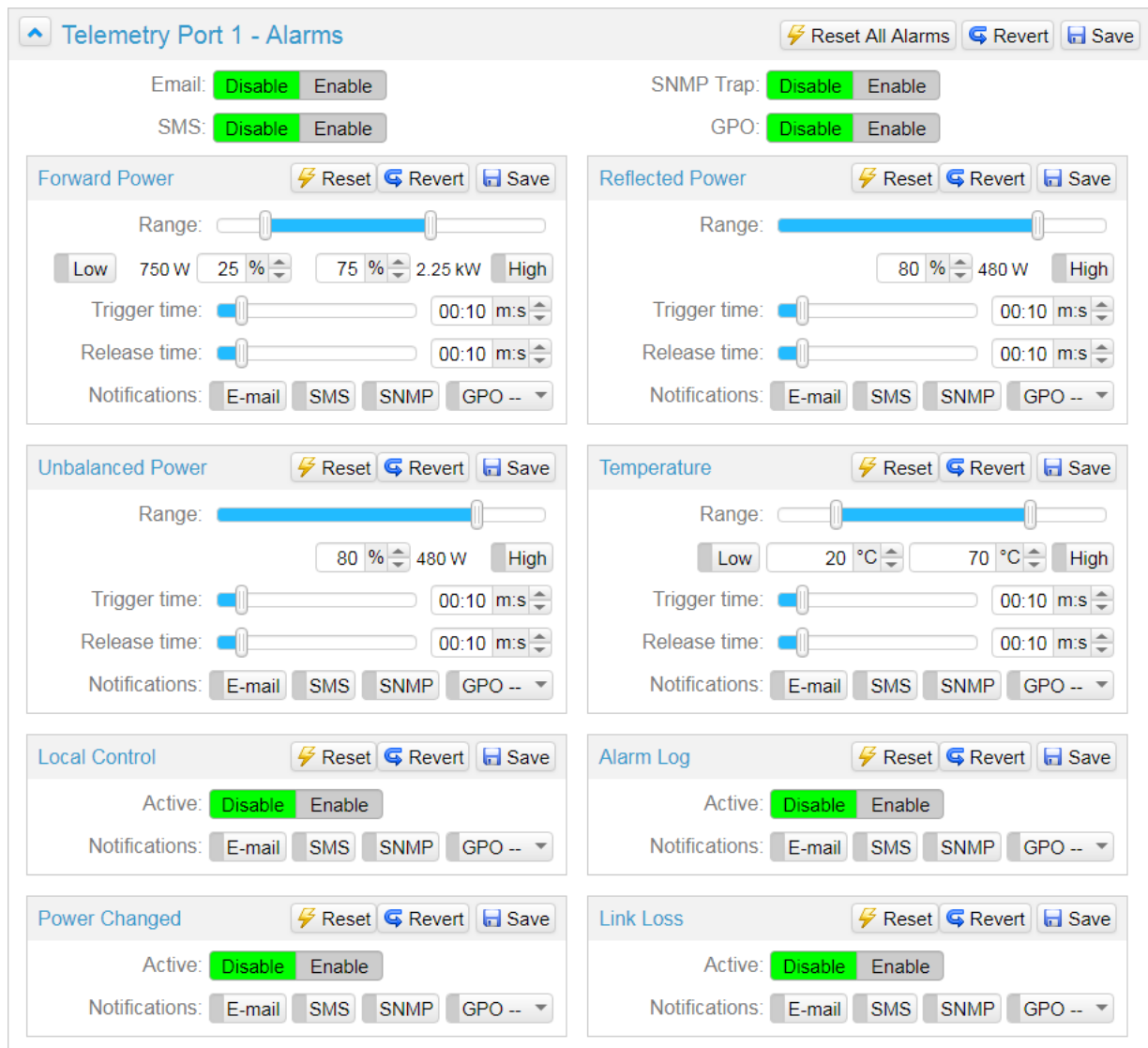

The screenshot shows the 'Telemetry Port 1 - Alarms' configuration page. At the top, there are global settings for Email, SMS, SNMP Trap, and GPO, each with 'Disable' and 'Enable' buttons. Below are eight individual alarm configuration panels, each with 'Reset', 'Revert', and 'Save' buttons:

- Forward Power:** Range slider, Low (750 W, 25%), High (2.25 kW, 75%), Trigger time (00:10 m:s), Release time (00:10 m:s), Notifications (E-mail, SMS, SNMP, GPO).
- Reflected Power:** Range slider, High (480 W, 80%), Trigger time (00:10 m:s), Release time (00:10 m:s), Notifications (E-mail, SMS, SNMP, GPO).
- Unbalanced Power:** Range slider, High (480 W, 80%), Trigger time (00:10 m:s), Release time (00:10 m:s), Notifications (E-mail, SMS, SNMP, GPO).
- Temperature:** Range slider, Low (20 °C), High (70 °C), Trigger time (00:10 m:s), Release time (00:10 m:s), Notifications (E-mail, SMS, SNMP, GPO).
- Local Control:** Active (Disable/Enable), Notifications (E-mail, SMS, SNMP, GPO).
- Alarm Log:** Active (Disable/Enable), Notifications (E-mail, SMS, SNMP, GPO).
- Power Changed:** Active (Disable/Enable), Notifications (E-mail, SMS, SNMP, GPO).
- Link Loss:** Active (Disable/Enable), Notifications (E-mail, SMS, SNMP, GPO).

For some signals, both high and low threshold are monitored (Forward Power, Temperature, Modulation), while for others - only high threshold is (Reflected and Unbalanced Power). A notification is sent whenever the value passes the threshold (alarm activation) and upon its return to normal status (Idle).

An alarm notification is also sent in the case of an event such as loss of connection with the monitored device. For this type of alarm, no threshold or delay is set. For some events, it is not necessary to send a notification for the return to normal values – for example that is the case with power change.

To set up an email notification, the following must be fulfilled:

- the [E-mail] button in the Notifications for the alarm must be enabled;
- e-mail notification must be enabled for the entire Telemetry Port;
- a receiver must be entered in *Settings> Device> E-mail*. ([see “E-mail” on page 24](#))

To set up an SNMP trap notification, the following must be fulfilled:

- the [SNMP] button in the Notifications for the alarm must be enabled;
- SNMP trap notification must be enabled for the entire Telemetry Port;
- a receiver must be entered in *Settings> Device> SNMP Agent> Manager IP*. ([see “SNMP Agent” on page 23](#))

To set up an SMS notification, the following must be fulfilled:

- the [SMS] button in the Notifications for the alarm must be enabled;
- SMS notification must be enabled for the entire Telemetry Port;
- GSM modem must be connected and enabled in *Settings> Device> GSM Modem*. ([see “GSM Modem” on page 25](#))

To set up a GPO notification, the following must be fulfilled:

- the output must be selected from the [GPO] button in Notifications for the alarm;
- GPO notification must be enabled for the entire Telemetry Port;
- the Alarm Output function must be set for the respective output in *Settings> Device> GPO*. ([see “General-Purpose Outputs” on page 26](#))

The alarm thresholds are used to highlight signal values. If the alarm is not enabled, the threshold pass is still registered with the highlighting of the signal.

The alarm can be enabled without any Notifications being selected. In this case, the main screen will show the abnormal signal in the alarm indicators field but will not send any activation notifications.

When both the alarm and the Notifications are enabled, upon activation of the alarm a notification will be sent and there will also be an indication on the main screen.

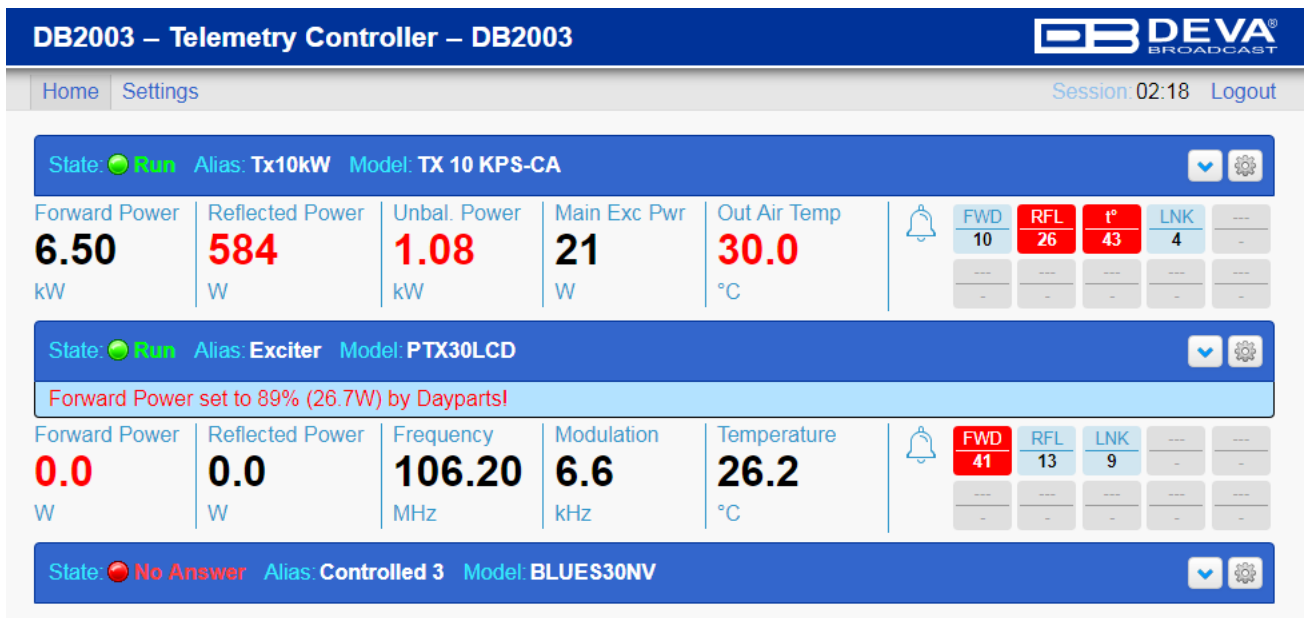

Telemetry and Telecontrol

WEB INTERFACE – HOME



The screenshot shows the 'DB2003 – Telemetry Controller – DB2003' interface. It features a top navigation bar with 'Home' and 'Settings' links, and a session timer '02:18' with a 'Logout' button. The main content area displays three telemetry ports:

- Port 1 (Tx10kW, Model: TX 10 KPS-CA):** State: Run. Main signals: Forward Power 6.50 kW, Reflected Power 584 W, Unbal. Power 1.08 kW, Main Exc Pwr 21 W, Out Air Temp 30.0 °C. Alarm indicators: FWD (10), RFL (26), I° (43), LNK (4).
- Port 2 (Exciter, Model: PTX30LCD):** State: Run. Forward Power set to 89% (26.7W) by Dayparts. Main signals: Forward Power 0.0 W, Reflected Power 0.0 W, Frequency 106.20 MHz, Modulation 6.6 kHz, Temperature 26.2 °C. Alarm indicators: FWD (41), RFL (13), LNK (9).
- Port 3 (Controlled 3, Model: BLUES30NV):** State: No Answer.

The image above shows the main panel of the WEB interface for three allowed Telemetry Ports. The upper section contains the bar showing the port status, as well as the Alias and model of the monitored device. On the right-hand side of the bar are the button that displays/hides the read signal values  and the button that displays telecontrol parameters . When the user has no admin rights, this button is not active. The middle section shows the blue bar, which indicates enabled Dayparts, as well as the power currently set.

Next comes the field with the five main signals. They differ in accordance with the model of the selected monitored device. The right-hand section of the field shows the indicators for the enabled alarms. If the status is different from Run, this section is not displayed, as illustrated by the lower section of the image for Telemetry Port 3.

NOTE: Screenshots are taken from simulated devices, rather than monitored ones in actual operation. The signal values in the images may therefore not be consistent.



The values of the main signals get highlighted in red when the set alarm thresholds are passed. This happens even when the alarm is not Enabled – as illustrated by Unbalanced Power in the upper section of the image. The value is in red but there is no Unbalanced Power alarm indicator on the right. The value becomes highlighted as soon as the threshold is passed, while the alarm becomes active once the Trigger Time elapses. The value returns to black as soon as the signal is restored to normal, while the alarm will remain on until the Release Time elapses.

Alarm indicators . The gray field is a placeholder, with no Enabled alarm. The pink ones indicate which alarms have been enabled, as well as the current Idle status. The number below the line shows the number of times the alarm has been activated after the latest resetting. The indicators in red show active alarms. The alarm abbreviations are shown in the Alarms List table.

Click or tap on the Alarm indicator to reset single alarm counter. Click or tap on the  bell icon to reset all alarm counters on this telemetry port.

READINGS

All the information read from the monitored device is displayed when the following button is pressed: . Depending on the model, the information can be displayed in one of two ways: as a list or using tabs.

State: ● Run Alias: Exciter Model: PTX30LCD					 											
Forward Power set to 89% (26.7W) by Dayparts!																
Forward Power 0.0 W	Reflected Power 0.0 W	Frequency 106.20 MHz	Modulation 6.6 kHz	Temperature 26.2 °C		<table border="1"> <tr> <td>FWD 41</td> <td>RFL 13</td> <td>LNK 9</td> <td>---</td> <td>---</td> </tr> <tr> <td>---</td> <td>---</td> <td>---</td> <td>---</td> <td>---</td> </tr> </table>	FWD 41	RFL 13	LNK 9	---	---	---	---	---	---	---
FWD 41	RFL 13	LNK 9	---	---												
---	---	---	---	---												
Deviation Left: <u>0.0</u> kHz		Deviation Right: <u>0.0</u> kHz		Deviation SCA1: <u>0.0</u> kHz		Deviation SCA2: <u>0.0</u> kHz										
Deviation RDS: <u>0.0</u> kHz		On Air: <u>Off</u>		Target Power: <u>20</u> %		Input Mode: <u>Stereo</u>										
<table border="1"> <tr> <td>Status</td> <td>Regulate</td> <td>Measure</td> <td colspan="4"></td> </tr> </table>							Status	Regulate	Measure							
Status	Regulate	Measure														
Power Set OK: <u>Off</u>		Interlock: <u>Absent</u>		PLL Lock: <u>On</u>		General Alarm: <u>Absent</u>										
SWR Alarm: <u>Absent</u>		Audio Loss: <u>Present</u>		Panel Access: <u>Absent</u>												

The image above shows the information as a list. Depending on the selected browser window width, the list can be organized in 4, 3 or 2 columns. The information is ordered first by row, and then by column. The number of signals is in accordance with the selected model of the monitored device. The list does not repeat main signals already displayed in the main signals field.

Pressing the button again (arrow pointing up this time) hides the list.

The second way of displaying information shows it grouped in tabs. This method is used with Plug-in and Barracuda monitored devices.

State: ● Run Alias: Tx10kW Model: TX 10 KPS-CA
↑ ⚙

Forward Power 6.50 kW	Reflected Power 584 W	Unbal. Power 1.08 kW	Main Exc Pwr 21 W	Out Air Temp 30.0 °C	🔔	FWD 10	RFL 26	I° 43	LNK 4	---
------------------------------------	------------------------------------	-----------------------------------	--------------------------------	-----------------------------------	---	-----------	-----------	----------	----------	-----

Status | Control Unit | Power Supply | Combiner | RF Units | Alarm Log | Release | Configuration

Main Source: **Exciter 2** Hours: **3638**

Unit	Status	Event	Reason
Control Unit	On	Low Power	35% (3.50 kW)
Power Supply	On		
Combiner	On		
RF Unit 1	On-Fault	Retry	MOS Current
RF Unit 2	Time-Out		
RF Unit 3	Time-Out		
RF Unit 4	Time-Out		
RF Unit 5	Time-Out		

The image above shows the Status tab. Only one RF Unit is simulated, with its status Fault due to high current at one of the end MOS transistors. The system is set to work in low power mode.

Status | Control Unit | Power Supply | Combiner | RF Units | Alarm Log | Release | Configuration

Local/Remote: Remote	Selected Power: Lower	Exc Changeover: Auto	LED Fault: Off
LED Wait: Off	LED Warning: Off	Ext Interlock: Absent	Aux Interlock: Absent
Exc1 Aud Alarm: Absent	Exc2 Aud Alarm: Absent	Reserve 2: Absent	Exciter 1 Mute: On
Exciter 2 Mute: Off	Exciter's Mains: On	Total Efficiency: 100 %	Standby Input: Absent
Standby Out: Off			

Status | Control Unit | Power Supply | Combiner | RF Units | Alarm Log | Release | Configuration

Bus Voltage: 44.7 V	In Air Temperature: 27.0 °C	Safety Key: Absent	Mains Fault: Absent
C.B. Power Fan: Absent	C.B. Blowers: Absent	Clk Blower: Absent	Top Blower: Off
K.M.G. Output: On	Power Fan: On	RF Enable: On	

Status | Control Unit | Power Supply | Combiner | RF Units | Alarm Log | Release | Configuration

StBy Exc Pwr: 0 W	RejLd Temperature: 34.0 °C	S.W.R.: 2.0	Target Power: 35 %
Overtemp IntDL: Absent	Aux Fan: Off	Out Set 1: Off	Out Set 2: Off
Out Set 3: On	Out Set 4: On	RF Enable: On	

The tabs below show signals as a list, grouped by Plug-in Units.

With RF Units, there are sub-tabs. The first one shows as a table the information from all RF Units, while the next ones – the information of each unit separately as a list.

Signal	RF Unit 1	RF Unit 2	RF Unit 3	RF Unit 4	RF Unit 5
Unit Status	Time-Out	On	Time-Out	Time-Out	Time-Out
Forward Power		1.80 kW			
Reflected Power		24 W			
Input Power		19 W			
PA Voltage		50.0 V			
Bias Voltage		-9.0 V			
Temperature		36.0 °C			
Driver Current		1.78 A			
MOS-1 Current		17.1 A			
MOS-2 Current		18.1 A			
MOS-3 Current		17.5 A			
Efficiency		66 %			
Fan Speed		100 %			
Overtemp Alarm		Absent			
Alarm Unbalanced		Absent			
PS Fuse Alarm		Absent			
Green LED		On			
Orange LED		On			
Red LED		On			
Unit Interlock		Present			
RF Enable		On			

Unit State:
Time-Out

Forward Power: 1.81 kW	Reflected Power: 24 W	Input Power: 19 W
PA Voltage: 50.0 V	Bias Voltage: -9.0 V	Temperature: 36.0 °C
Driver Current: 1.78 A	MOS-1 Current: 17.1 A	MOS-2 Current: 18.1 A
MOS-3 Current: 17.5 A	Efficiency: 66 %	Fan Speed: 100 %
Overtemp Alarm: Absent	Alarm Unbalanced: Absent	PS Fuse Alarm: Absent
Green LED: On	Orange LED: On	Red LED: Off
Unit Interlock: Present	RF Enable: On	

This illustrates the reason for the Fault status of the RF Unit – high current at MOS-1, also highlighted in red.

The next tab, Alarm Log, shows the contents of the log read from the monitored device. The following recorded logs are demonstrated here, reflecting the events involved in reaching a Fault status of RF Unit 2.

Date	Time	Module	Event	Source
2019-05-21	12:19	Power Supply	Fault	C.B. Power Fan
2015-12-22	19:21	Power Supply	Fault	C.B. Power Fan
2015-12-22	19:21	Power Supply	Wait	Mains Fault
2015-12-22	19:20	Power Supply	Wait	C.B. Top Fan

These are the Alarm Log contents of the monitored device. It is not connected to the port or system logs recorded by the DB2003.

Plug-in records in its Alarm Log in accordance with its configuration (more on which will be discussed further on). These logs are not affected by the DB2003 settings. They are just displayed here. The entire log can be deleted with a command by a DB2003 operator ([see “Telecontrol” on page 45](#)).

Module	Address	Config ID	SW Version	HW Ver	Ser Num 1	Ser Num 2
Control Unit	2	10000	CCUP-GL0103 1.40 22-12-2015	1.0	54596	13581
Power Supply	1	10000	PCPU-GL0103 1.80 27-02-2014	1.0	65535	65535
Combiner	4	10000	PCPU-GL0103 1.80 27-02-2014	1.0	65535	65535
RF Unit 1	8	Time-Out				
RF Unit 2	9	10000	PCPU-GL0103 1.80 27-02-2014	1.0	65535	65535
RF Unit 3	10	Time-Out				
RF Unit 4	11	Time-Out				
RF Unit 5	12	Time-Out				

Next comes the Release tab, displaying the Transmitter’s units, identification serial numbers of the entire transmitter and the separate units, as well as the firmware version in use for each unit. (The image above shows simulated information, any resemblance to a real device is unintentional.)

The information in the Configuration tab is again grouped into sub-tabs. Sub-tab Settings display parameters which the Plug-in user can edit through the transmitter's front panel and some of which can be edited even remotely via the DB2003.

Status Control Unit Power Supply Combiner RF Units Alarm Log Release Configuration

Settings Control Unit Power Supply Combiner RF Units

Nominal Power: **85% (8.50 kW)** Low Power: **35% (3.50 kW)**

Set	Label	Assign	Limit
Set1	SET1	Forward Power	87% (8.70 kW)
Set2	SET2	Forward Power	55% (5.50 kW)
Set3	SET3	Reflected Power	65% (520 W)
Set4	SET4	Reflected Power	44% (352 W)

Exc Wait Time: **12 s** Exciter: **Dual** Config N+1: **No**
 L.P. Timer: **Manual** Polarization: **Analog**

Status Control Unit Power Supply Combiner RF Units Alarm Log Release Configuration

Settings Control Unit Power Supply Combiner RF Units

Signal	Nominal	Low	High	Action
Input Power	30 W	13 W		

Reserve 1: **Disable** Reserve 2: **Enable** Reserve 3: **Disable**
 Reserve 4: **Disable** Fast Exchange: **Disable**

Sub-tab Control Unit shows the minimum power at the transmitter's input, under which a changeover of exciters will be carried out if the automatic Exciter changeover mode is selected.

Status Control Unit Power Supply Combiner RF Units Alarm Log Release Configuration

Settings Control Unit Power Supply Combiner RF Units

Signal	Nominal	Low	High	Action
Temperature	100 °C		55 °C	Wait
Bus Voltage	50 V	40 V	50 V	

Top Blower: **Enable**

Status Control Unit Power Supply Combiner RF Units Alarm Log Release Configuration

Settings Control Unit Power Supply Combiner RF Units

Signal	Nominal	Low	High	Action
Forward Power	10.00 kW		12.00 kW	Retry 8
Reflected Power	800 W		800 W	Retry 8
Unbalanced Power	3.50 kW		3.50 kW	Retry 8
Input Power	30 W		30 W	Retry 8
RejLd Temperature	100 °C		100 Å°C	Wait
In Air Temperature	100 °C		100 °C	Wait
S.W.R.		1.0	6.0	Retry 8
Ext Fwd Power	Disabled			
Ext Rfl Power	Disabled			
Ext Unb Power	Disabled			

Internal D.Load: **Enable**

The Action column shows the action the unit would undertake if the upper threshold of the respective signal is passed. Action has one of three values: Wait, Retry or Fault. Wait means that no

action is undertaken; the event is only recorded in the log. With Retry, the set number of attempts is undertaken to return the signal to normal value. If the attempts are unsuccessful, the status switches to Fault and the unit switches off. When the value is Fault, the unit immediately switches off.

These are the signal limits – passing them creates Alarm log entries. These values are set by the manufacturer during production of the transmitter. Here, they are displayed in order to inform users of the types of situations that would lead to Alarm log entries.

Signal	Nominal	Low	High	Action
Forward Power	2.10 kW		2.52 kW	Retry 8
Reflected Power	200 W		240 W	Retry 8
Input Power	40 W		40 W	Fault
Supply Voltage	50 V			
Bias Voltage	9 V			
Temperature	90 °C		90 °C	Wait
Driver Current	2.00 A		2.00 A	Wait
MOS Current	30 A		36 A	Retry 8
Efficiency		10 %	90 %	Wait

MOS-2 Available: **Yes** MOS-3 Available: **Yes** MOS-4 Available: **No**
 Overtemp Alarm: **Enable** PS Fuse Alarm: **Enable** Derating: **Enable**

This table shows the signal values for all RF Units. As with Combiner, it displays the actions which would be undertaken by the respective RF Unit if the signal limit is passed.

For the signals which do not have a DB2003 alarm, configuration thresholds are used to highlight the signal value. This applies to all RF Units signals.

In the configuration table of the RF Units, the high threshold for MOS current is 36A, and the action is Retry 8. The Alarm Log image shows the attempts to restore the respective parameter to normal. Failure has led to a Fault status.

TELECONTROL

Pressing this button  shows the parameters subject to telecontrol. This is accessible only for users with admin rights.

For telecontrol operations to be carried out, the required new values of the parameters must be set. Commands will be carried out after the [Save] button is pressed.

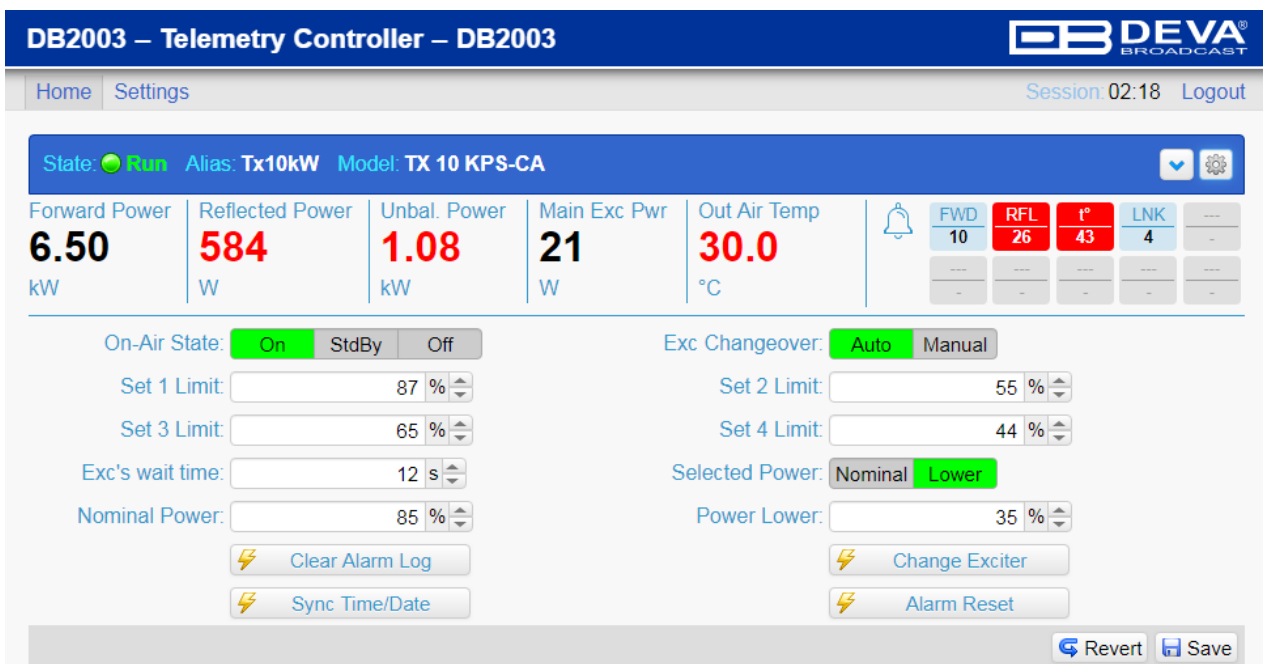

In order for the respective action to be carried out immediately, the button marked with a lightning sign () must be pressed. There is no need to press [Save].

Plug-in Telecontrol Parameters







DB2003 – Telemetry Controller – DB2003 

Home Settings Session 02:18 Logout

State: ● Run Alias: Tx10kW Model: TX 10 KPS-CA  

Forward Power 6.50 kW	Reflected Power 584 W	Unbal. Power 1.08 kW	Main Exc Pwr 21 W	Out Air Temp 30.0 °C		FWD 10	RFL 26	T° 43	LNK 4	---
------------------------------------	------------------------------------	-----------------------------------	--------------------------------	-----------------------------------	---	-----------	-----------	----------	----------	-----

On-Air State: On StdBy Off	Exc Changeover: Auto Manual
Set 1 Limit: <input type="text" value="87"/> %	Set 2 Limit: <input type="text" value="55"/> %
Set 3 Limit: <input type="text" value="65"/> %	Set 4 Limit: <input type="text" value="44"/> %
Exc's wait time: <input type="text" value="12"/> s	Selected Power: Nominal Lower
Nominal Power: <input type="text" value="85"/> %	Power Lower: <input type="text" value="35"/> %

 Clear Alarm Log
 Change Exciter
 Sync Time/Date
 Alarm Reset

↶ Revert 💾 Save

The image above shows the telecontrol parameters for a Plug-in transmitter. All parameters subject to telecontrol are displayed, due to the fact that Dayparts are Disabled.

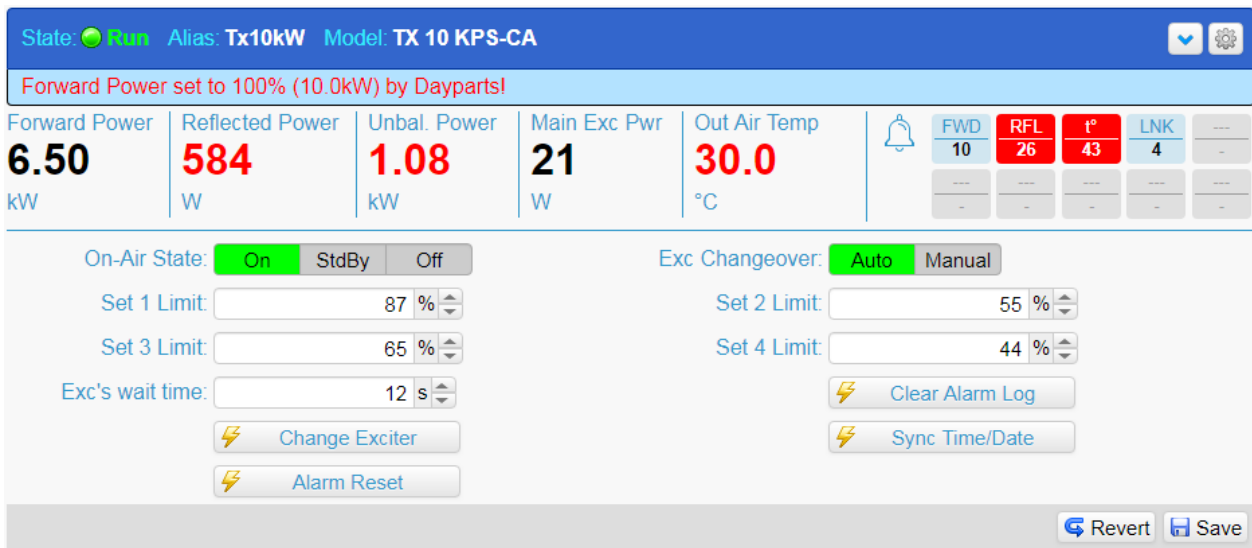

State: ● Run Alias: Tx10kW Model: TX 10 KPS-CA

Forward Power set to 100% (10.0kW) by Dayparts!

Forward Power 6.50 kW	Reflected Power 584 W	Unbal. Power 1.08 kW	Main Exc Pwr 21 W	Out Air Temp 30.0 °C	<input type="checkbox"/> FWD 10 <input type="checkbox"/> RFL 26 <input type="checkbox"/> t° 43 <input type="checkbox"/> LNK 4 <input type="checkbox"/> ... <input type="checkbox"/> ... <input type="checkbox"/> ... <input type="checkbox"/> ...
------------------------------------	------------------------------------	-----------------------------------	--------------------------------	-----------------------------------	--

On-Air State: On StdBy Off

Exc Changeover: Auto Manual

Set 1 Limit: %

Set 2 Limit: %

Set 3 Limit: %

Set 4 Limit: %

Exc's wait time: s

Buttons: Change Exciter, Alarm Reset, Clear Alarm Log, Sync Time/Date

Revert Save

This image shows the telecontrol parameters for a Plug-in transmitter when Dayparts are Enabled. The power control parameters are under the control of Dayparts and cannot be managed remotely by an operator – the Nominal/Lower Power button and the values for the two thresholds.

The [Change Exciter] button causes an exciter changeover. For that action to be successful, the exciter changeover mode must be “Manual” (that is not the case in the image above). Pressing this button is equivalent to performing the same action through the Exciters menu on the transmitter’s front panel.

The [Alarm Reset] button cancels the Fault status. It is equivalent to pressing the same button on the transmitter’s front panel.

The [Clear Alarm Log] button deletes the transmitter’s log. **WARNING:** This action is irreversible – once deleted, the Alarm log data cannot be restored.

The [Sync Time/Date] button synchronizes the transmitter’s time (used in the Alarm log) with that of the DB2003. The DB2003 cannot be aware of the Plug-in time, so it is impossible to know what the correction is when this action is performed.

The difference between Plug-in time and DB2003 time can be inferred from the System Log data of the DB2003 when “Alarm Log” is Enabled:

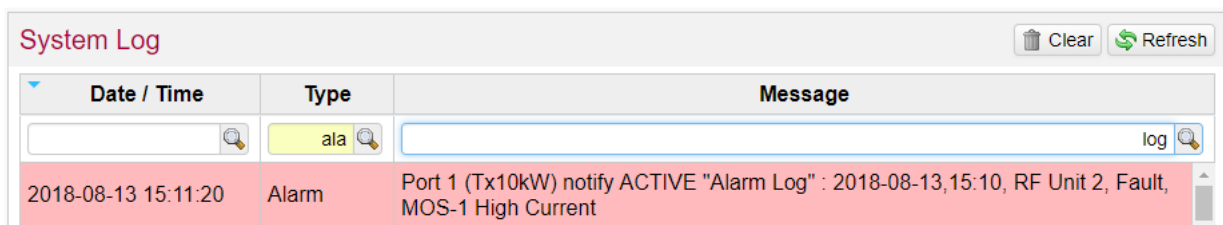

Date / Time	Type	Message
2018-08-13 15:11:20	Alarm	Port 1 (Tx10kW) notify ACTIVE "Alarm Log" : 2018-08-13,15:10, RF Unit 2, Fault, MOS-1 High Current

The time shown in the Date/Time column is from the DB2003, while the time in the Message column is from the Plug-in.

The time synchronization command for Plug-in is rounded off in whole minutes, without seconds. This means that when the button is pressed, the DB2003 receives a synchronization request and in fact sends a command to the Plug-in shortly before the start of a new minute.

PTX_LCD Control Parameters

The images below illustrate the effect of the Edit Dangerous Parameters setting for the PTX_LCD models. In the first image the value is 'Disabled' and the dangerous 'Frequency' parameter is not available for telecontrol.

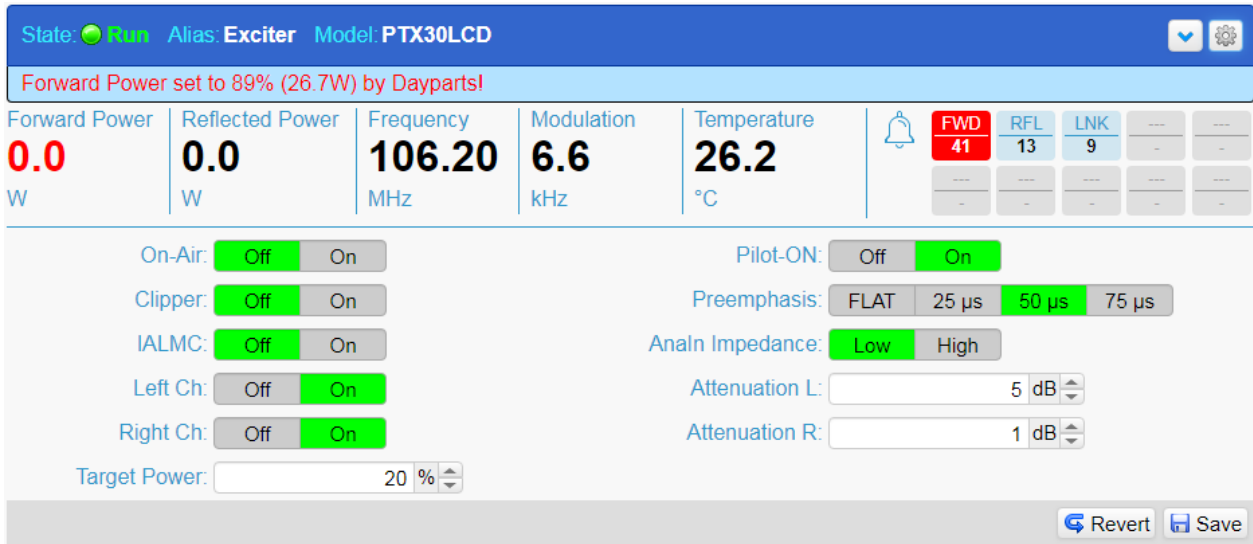

State: ● Run Alias: Exciter Model: PTX30LCD

Forward Power set to 89% (26.7W) by Dayparts!

Forward Power 0.0 W	Reflected Power 0.0 W	Frequency 106.20 MHz	Modulation 6.6 kHz	Temperature 26.2 °C	<div style="display: flex; justify-content: space-around;"> <div style="border: 1px solid gray; padding: 2px;">FWD 41</div> <div style="border: 1px solid gray; padding: 2px;">RFL 13</div> <div style="border: 1px solid gray; padding: 2px;">LNK 9</div> </div>
----------------------------------	------------------------------------	-----------------------------------	---------------------------------	----------------------------------	---

On-Air: Off On

Clipper: Off On

IALMC: Off On

Left Ch: Off On

Right Ch: Off On

Pilot-ON: Off On

Preemphasis: FLAT 25 µs **50 µs** 75 µs

Analn Impedance: Low High

Attenuation L: dB

Attenuation R: dB

Target Power: %

Revert Save

In the second image the value of the Edit Dangerous Parameters setting is 'Enabled', and the dangerous 'Frequency' parameter is available for telecontrol. It is also marked by a warning sign.

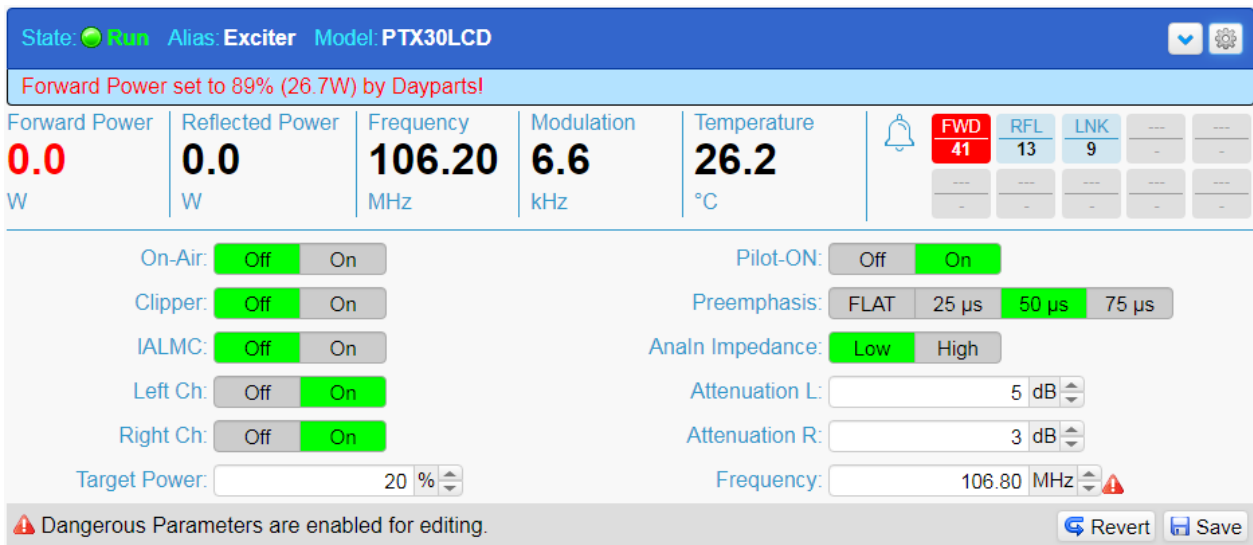

State: ● Run Alias: Exciter Model: PTX30LCD

Forward Power set to 89% (26.7W) by Dayparts!

Forward Power 0.0 W	Reflected Power 0.0 W	Frequency 106.20 MHz	Modulation 6.6 kHz	Temperature 26.2 °C	<div style="display: flex; justify-content: space-around;"> <div style="border: 1px solid gray; padding: 2px;">FWD 41</div> <div style="border: 1px solid gray; padding: 2px;">RFL 13</div> <div style="border: 1px solid gray; padding: 2px;">LNK 9</div> </div>
----------------------------------	------------------------------------	-----------------------------------	---------------------------------	----------------------------------	---

On-Air: Off On

Clipper: Off On

IALMC: Off On

Left Ch: Off On

Right Ch: Off On

Pilot-ON: Off On

Preemphasis: FLAT 25 µs **50 µs** 75 µs

Analn Impedance: Low High

Attenuation L: dB

Attenuation R: dB

Frequency: MHz ⚠

Target Power: %

⚠ Dangerous Parameters are enabled for editing.

Revert Save

In the image below the value of the Edit Dangerous Parameters settings is 'For a limited time' and the dangerous 'Frequency' parameter can be edited in the remaining time indicated in the gray bar (in this case 45 seconds). Once that time elapses, the new value will not be accepted.



It is recommended that the frequency change should be made separately, without any other parameters being changed when the [Save] button is pressed.

State: ● Run Alias: Exciter Model: PTX30LCD

Forward Power set to 89% (26.7W) by Dayparts!

Forward Power 0.0 W	Reflected Power 0.0 W	Frequency 106.20 MHz	Modulation 6.6 kHz	Temperature 26.2 °C	 <table border="1"> <tr> <td style="background-color: red; color: white;">FWD 41</td> <td>RFL 13</td> <td>LNK 9</td> <td>---</td> <td>---</td> </tr> <tr> <td>---</td> <td>---</td> <td>---</td> <td>---</td> <td>---</td> </tr> </table>	FWD 41	RFL 13	LNK 9	---	---	---	---	---	---	---
FWD 41	RFL 13	LNK 9	---	---											
---	---	---	---	---											

On-Air: <input type="checkbox"/> Off <input type="checkbox"/> On	Pilot-ON: <input type="checkbox"/> Off <input checked="" type="checkbox"/> On
Clipper: <input type="checkbox"/> Off <input type="checkbox"/> On	Preemphasis: FLAT 25 μs <input checked="" type="checkbox"/> 50 μs 75 μs
IALMC: <input type="checkbox"/> Off <input type="checkbox"/> On	Analn Impedance: <input checked="" type="checkbox"/> Low <input type="checkbox"/> High
Left Ch: <input type="checkbox"/> Off <input checked="" type="checkbox"/> On	Attenuation L: <input type="text" value="5"/> dB
Right Ch: <input type="checkbox"/> Off <input checked="" type="checkbox"/> On	Attenuation R: <input type="text" value="3"/> dB
Target Power: <input type="text" value="20"/> %	Frequency: <input type="text" value="106.80"/> MHz 



 Disabling Dangerous Parameters after 36 sec.  Revert  Save

In all three images above, Dayparts are Enabled and Target Power is not available for telecontrol. In the image below, Dayparts are Disabled and Target Power is available for telecontrol (there is no blue bar).

State: ● Run Alias: Exciter Model: PTX30LCD

Forward Power 0.0 W	Reflected Power 0.0 W	Frequency 106.20 MHz	Modulation 6.6 kHz	Temperature 26.2 °C	 <table border="1"> <tr> <td style="background-color: red; color: white;">FWD 41</td> <td>RFL 13</td> <td>LNK 9</td> <td>---</td> <td>---</td> </tr> <tr> <td>---</td> <td>---</td> <td>---</td> <td>---</td> <td>---</td> </tr> </table>	FWD 41	RFL 13	LNK 9	---	---	---	---	---	---	---
FWD 41	RFL 13	LNK 9	---	---											
---	---	---	---	---											

On-Air: <input type="checkbox"/> Off <input type="checkbox"/> On	Pilot-ON: <input type="checkbox"/> Off <input checked="" type="checkbox"/> On
Clipper: <input type="checkbox"/> Off <input type="checkbox"/> On	Preemphasis: FLAT 25 μs <input checked="" type="checkbox"/> 50 μs 75 μs
IALMC: <input type="checkbox"/> Off <input type="checkbox"/> On	Analn Impedance: <input checked="" type="checkbox"/> Low <input type="checkbox"/> High
Left Ch: <input type="checkbox"/> Off <input checked="" type="checkbox"/> On	Attenuation L: <input type="text" value="5"/> dB
Right Ch: <input type="checkbox"/> Off <input checked="" type="checkbox"/> On	Attenuation R: <input type="text" value="1"/> dB
Target Power: <input type="text" value="20"/> %	

 Revert  Save

Set the new values and press the [Save] button to send a command to the transmitter. There are no buttons here with immediate action (marked by a lightning sign). All commands are sent when the [Save] button is pressed. The more parameters are edited, the more time will be needed for sending the commands to the transmitter. Once the process is completed, the current values of the transmitter are displayed. Due to the large number of hardware varieties, some commands may not be carried out in accordance with user expectations. Please make sure all settings are correct after the process is completed. If necessary, repeat the action.

SNMP

SNMP is a convenient way of integrating the DB2003 into systems for automatic monitoring and control of multiple transmitters. It can be used with the help of a free Android application to check on the status or apply additional settings to the transmitter through a smartphone when the time or location is inconvenient.

This Guide uses screenshots from iReasoning MIB Browser Personal Edition – a free-of-charge version of an excellent software tool of sufficient functionality.

SNMP AGENT

SNMP Agent Revert Save

SNMP: Disable Enable

Agent Port:

Session Timeout: m:s

Read Community:

Write Community:

Agent ID:

Manager IP:

Manager Port:

SNMP Test: ⚡ Test Trap

SNMP MIB File: ↓ Download

For SNMP to work, SNMP Agent must be Enabled and the respective ports must be routed. Go to **Settings> Device> SNMP Agent** to set as Manager IP the IP address of the computer which is running the trap receiver.

Set an appropriate value for Agent ID in order to be able to identify the sender in the case of several DB2003's sending traps to the same receiver.

With the [Test Trap] button, you can check the negotiability of the entire route.

DB2003 uses SNMP v.2, with Read/Write Community serving as a password for granting reading and writing access respectively. Default values are shown. It is recommended those should be changed for security reasons.

MIB FILE

The latest version of the MIB file can be downloaded from the DB2003 with the press of the [Download] button in the SNMP Agent section on **Settings> Device**. This will download the DB2003-MIB.zip file containing DB2003-MIB.mib. Loading this file in the MIB browser will give you the following tree:

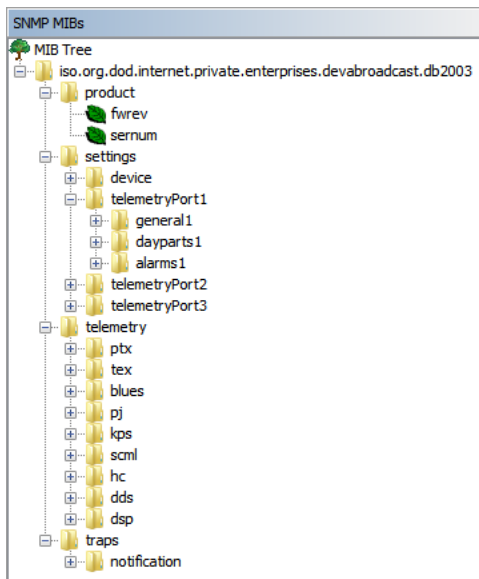

In the “product” folder are OID’s which allow users to identify instances of DB2003 – each manufactured device can be unambiguously identified by ‘sernum’ (it’s serial number).

The “settings” folder corresponds to Settings on the web page: under “device” are settings related to the DB2003 itself, while the “telemetry Port” folders contain settings related to the monitored devices connected on each port – General, Dayparts and Alarms.

Under the “telemetry” folder are OID for readings – this is information read from the monitored device.

There are folders for every Series containing a Readings Table. The table has three columns – one for each telemetry port.

For example, Telemetry port 2 monitors a PTX. The “port2” column shows readings from the PTX. The other columns show “bad PID” – there are no PTX’s connected to these telemetry ports.

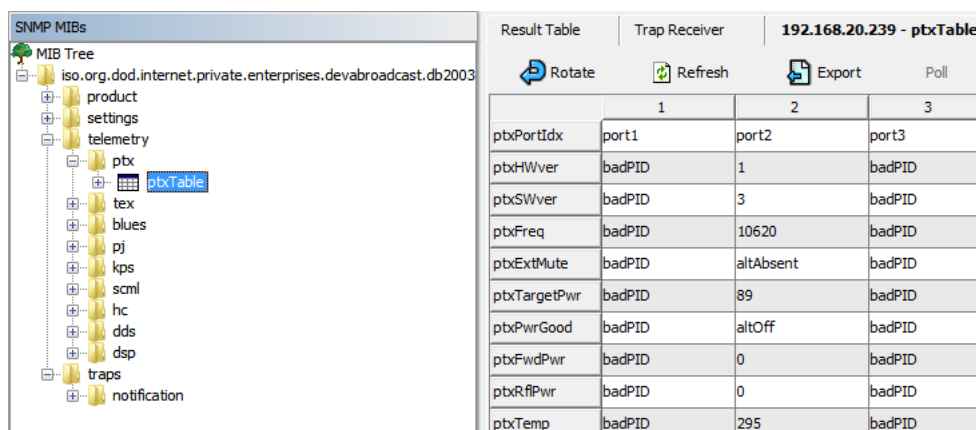

	1	2	3
ptxPortIdx	port1	port2	port3
ptxHWVver	badPID	1	badPID
ptxSWVver	badPID	3	badPID
ptxFreq	badPID	10620	badPID
ptxExtMute	badPID	altAbsent	badPID
ptxTargetPwr	badPID	89	badPID
ptxPwrGood	badPID	altOff	badPID
ptxFwdPwr	badPID	0	badPID
ptxRflPwr	badPID	0	badPID
ptxTemp	badPID	295	badPID

The table index starts from a zero value. The index for port1 is therefore 0, the one for port2 is 1, and the one for port3 is 2.

The table for PTX_LCD is indexed by OID ptxPortIdx, the one for TEX_LCD is indexed by texPortIdx, etc., each with values 0, 1 and 2 for the respective port.

For access to a separate signal, add the port index to the OID. For example, OID ptxFreq has the following value: .1.3.6.1.4.1.35833.2003.3.1.1.1.4

For access to the signal from port1, add .0 to the OID:

.1.3.6.1.4.1.35833.2003.3.1.1.1.4.0

For access to the signal from port2, add .1 to the OID:

.1.3.6.1.4.1.35833.2003.3.1.1.1.4.1

For access to the signal from port3, add .2 to the OID:

.1.3.6.1.4.1.35833.2003.3.1.1.1.4.2

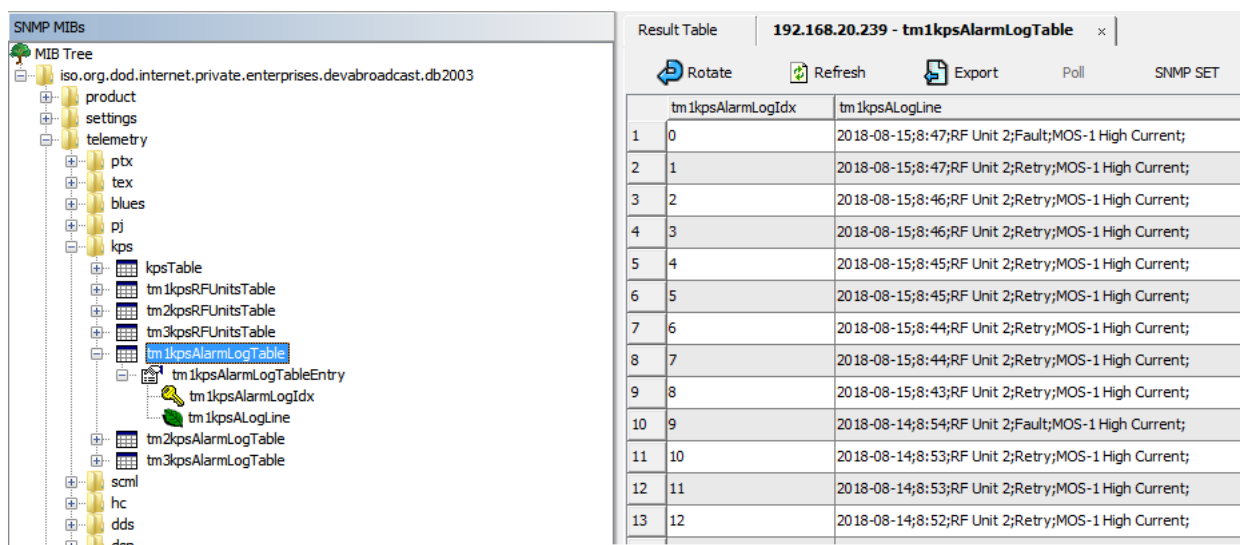

The screenshot shows the SNMP MIBs interface. On the left is a MIB Tree with a folder structure: iso.org.dod.internet.private.enterprises.devabroadcast.db2003 > product > settings > telemetry > kps > tm1kpsAlarmLogTable. On the right is a 'Result Table' for '192.168.20.239 - tm1kpsAlarmLogTable'. The table has two columns: 'tm1kpsAlarmLogIdx' and 'tm1kpsALogLine'. It contains 13 rows of data, each representing a log entry with a timestamp and a description of the alarm.

tm1kpsAlarmLogIdx	tm1kpsALogLine	
1	0	2018-08-15;8:47;RF Unit 2;Fault;MOS-1 High Current;
2	1	2018-08-15;8:47;RF Unit 2;Retry;MOS-1 High Current;
3	2	2018-08-15;8:46;RF Unit 2;Retry;MOS-1 High Current;
4	3	2018-08-15;8:46;RF Unit 2;Retry;MOS-1 High Current;
5	4	2018-08-15;8:45;RF Unit 2;Retry;MOS-1 High Current;
6	5	2018-08-15;8:45;RF Unit 2;Retry;MOS-1 High Current;
7	6	2018-08-15;8:44;RF Unit 2;Retry;MOS-1 High Current;
8	7	2018-08-15;8:44;RF Unit 2;Retry;MOS-1 High Current;
9	8	2018-08-15;8:43;RF Unit 2;Retry;MOS-1 High Current;
10	9	2018-08-14;8:54;RF Unit 2;Fault;MOS-1 High Current;
11	10	2018-08-14;8:53;RF Unit 2;Retry;MOS-1 High Current;
12	11	2018-08-14;8:53;RF Unit 2;Retry;MOS-1 High Current;
13	12	2018-08-14;8:52;RF Unit 2;Retry;MOS-1 High Current;

The “kps” folder contains several tables. They allow users to work with transmitters from the Plug-in and Barracuda series. The **kpsTable** contains information on Control Unit, Power Supply, Combiner, etc., without RF Units. It is indexed by Telemetry Port – 0, 1 and 2. The parameters for telecontrol of the transmitter are here.

There are three more tables here. These are for RF Units: **tm1kpsRFUnitsTable**, **tm2kpsRFUnitsTable** and **tm3kpsRFUnitsTable**. Select the appropriate one in accordance with the Telemetry Port where the transmitter is connected. These tables are indexed by RF Unit. The number of columns is determined by the number of RF Units of the selected model. Their content is similar to that of the WEB interface in the RF Units\All RF Units sub-tab.

The remaining three tables in the “kps” folder – **tm1kpsAlarmLogTable**, **tm2kpsAlarmLogTable** and **tm3kpsAlarmLogTable**, allow users to read the transmitter’s Alarm Log. Select the appropriate one in accordance with the Telemetry Port. These tables are indexed by the number of log entries. There may also be no entries. The **kpsTable** provides a **kpsALogAlter** flag, indicating a new entry. This table also provides **kpsALogLines** (number of log entries) but when the maximum length of the log is reached, this value is saturated. The image above shows the Alarm Log of a transmitter at Telemetry Port 1 – the index is arranged by rows for clarity. This is the same content as that shown above from the WEB interface’s Alarm Log tab.

SNMP GET & SNMP SET

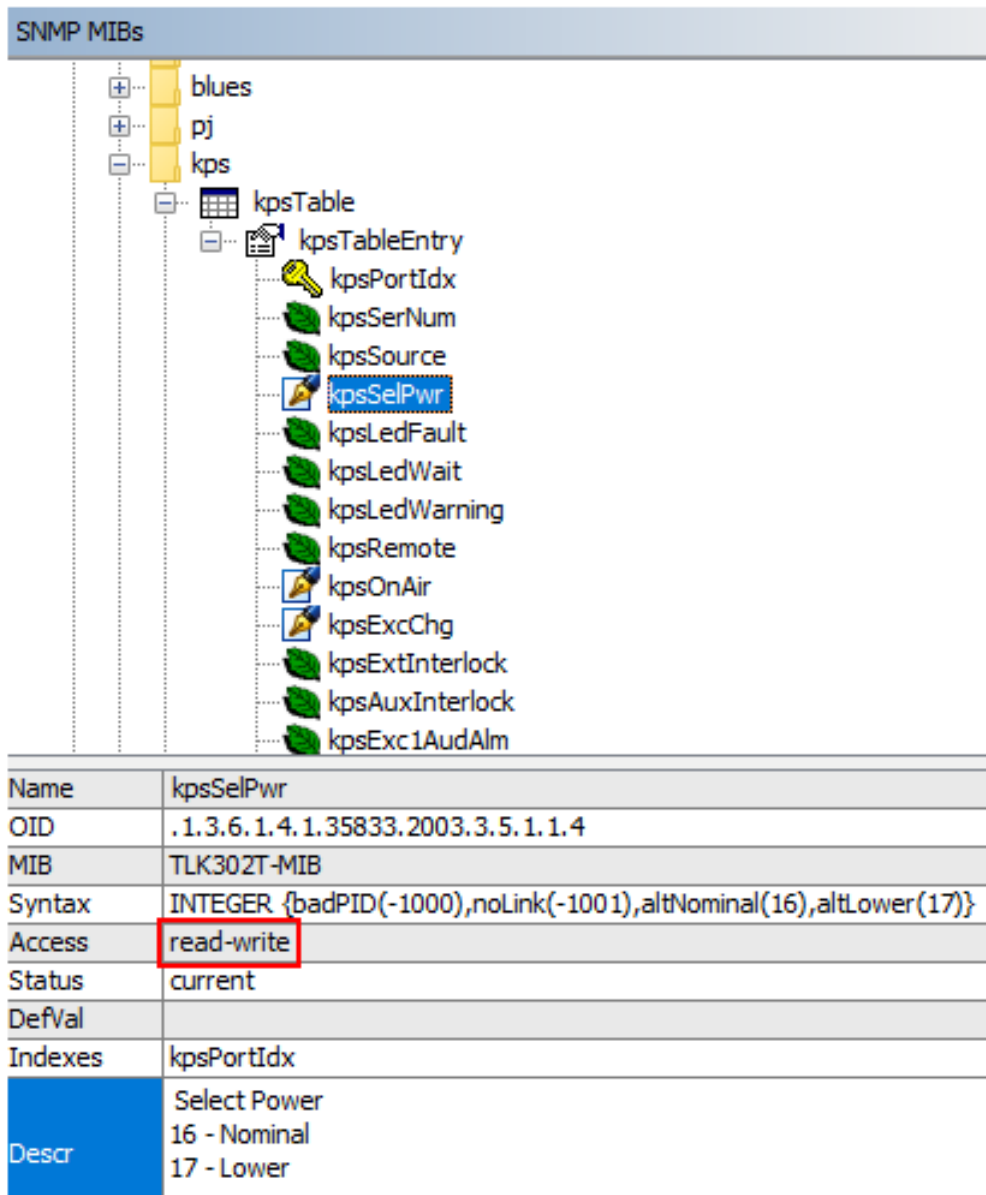

Name	kpsSelPwr
OID	.1.3.6.1.4.1.35833.2003.3.5.1.1.4
MIB	TLK302T-MIB
Syntax	INTEGER {badPID(-1000),noLink(-1001),altNominal(16),altLower(17)}
Access	read-write
Status	current
DefVal	
Indexes	kpsPortIdx
Descr	Select Power 16 - Nominal 17 - Lower

Some of the signals have read-only Access. These are the values read from the monitored device or the DB2003. In the MIB Browser read-only OID's are marked with a green leaf. Other OID's have read-write Access. In the MIB Browser they are marked with a pen.

By entering an appropriate value, you can perform telecontrol of the transmitter or a DB2003 setting. The same parameters are available to edit here as the ones available for telecontrol through the WEB interface.

By completing an SNMP set operation, a session is created in the DB2003. If another session has been running at the same time by admin or user, it is terminated. The duration of the SNMP session is selected in the SNMP Agent settings – Session Timeout. With a new recording operation, the duration of the session is renewed. With SNMP reading, no new session is created and it not affect the access of other users.

SNMP TRAP

Description	Source	Time	Sn
notifFwdPwrLow	192.168.20.239	2018-08-14 17:13:53	
notifSwrOk	192.168.20.239	2018-08-14 17:13:47	
notifFwdPwrOk	192.168.20.239	2018-08-14 17:13:34	
notifSwrAlarm	192.168.20.239	2018-08-14 17:13:25	
notifFwdPwrLow	192.168.20.239	2018-08-14 17:12:07	

Source:	192.168.20.239	Timestamp:	23 minutes 7 seconds	SNMP Ver	
Trap OID:	.iso.org.dod.internet.private.enterprises.devabroadcast.db2003.traps.notification.notifFwdPwrOk			Communi	
Variable Bindings:					
Name:	.iso.org.dod.internet.mgmt.mib-2.system.sysUpTime.0				
Value:	[TimeTicks] 23 minutes 7 seconds (138709)				
Name:	snmpTrapOID				
Value:	[OID] notifFwdPwrOk — 1				
Name:	.iso.org.dod.internet.private.enterprises.devabroadcast.db2003.settings.device.alias.0				
Value:	[OctetString] Rimini — 2				
Name:	.iso.org.dod.internet.private.enterprises.devabroadcast.db2003.settings.telemetryPort2.general2.controlledAlias2.0				
Value:	[OctetString] exciter — 3				
Name:	.iso.org.dod.internet.private.enterprises.devabroadcast.db2003.telemetry.ptx.ptxTable.ptxTableEntry.ptxFwdPwr.0 — 4				
Value:	[Integer] 76				
Name:	.iso.org.dod.internet.private.enterprises.devabroadcast.db2003.settings.device.snmp.snmpaid.0				
Value:	[Integer] 123 — 5				
Description:	notif Forward Power Ok — 6				

The image above shows how a received trap is deciphered. In this case, it is a notification for passing of the Forward Power alarm into Idle status – a return of forward power to the set limits.

The highlighted Field 1 contains the name of the received trap.

Field 2 contains the Alias of the DB2003 – the sender of the notification.

Field 3 contains the Alias of the port which caused the notification.

Field 4 contains the name of the signal being monitored by the alarm.

Field 5 contains the Agent ID as in the SNMP Agent settings. It serves to identify the sender, in addition of the one in Field 2.

Field 6 contains the description of the received trap, extracted from the MIB file loaded into an MIB Browser.

APPENDIX A

CABLES FOR CONNECTING TO THE MONITORED DEVICE

Cables must be shielded with a metal braid. The screen is soldered to the connectors' casing. The conductors must have be at least 0,22 sq. mm (23 SWG) across. Install the DB2003 close to the monitored device and make sure the cables are not unnecessarily long.

COM1 CONNECTOR

The COM1 Connector services only one RS232 interface of the point-to-point variety. The cable has one connector on each end – Male and Female. The connections are direct – Pin 2 to Pin 2, Pin 3 to Pin 3, Pin 5 to Pin 5 and Screen to Casing.

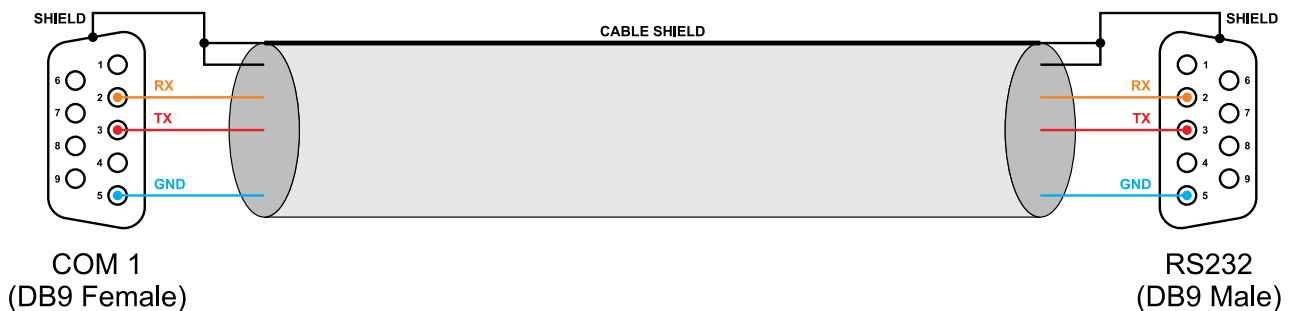

DB2003 COM1 to RS232 on Monitored Device

COM2 CONNECTOR

The COM2 Connector services three interfaces and GPO. At the most, four cables will come out of the connector:

- Cable 1 to RS232 connector on monitored device;
- Cable 2 to RS485 connector on Plug-in (only Plug-in series models use RS485);
- Cable 3 is for I²C bus;
- Cable 4 is for GPO, if used.

The figures below represent diagrams of the separate cables. When making your cable, please keep in mind that in all figures, COM2 could designate the same connector. At the most, the four cables will use four connections to the common ground. Only three pins are available, one of which will have to be shared by two cables.

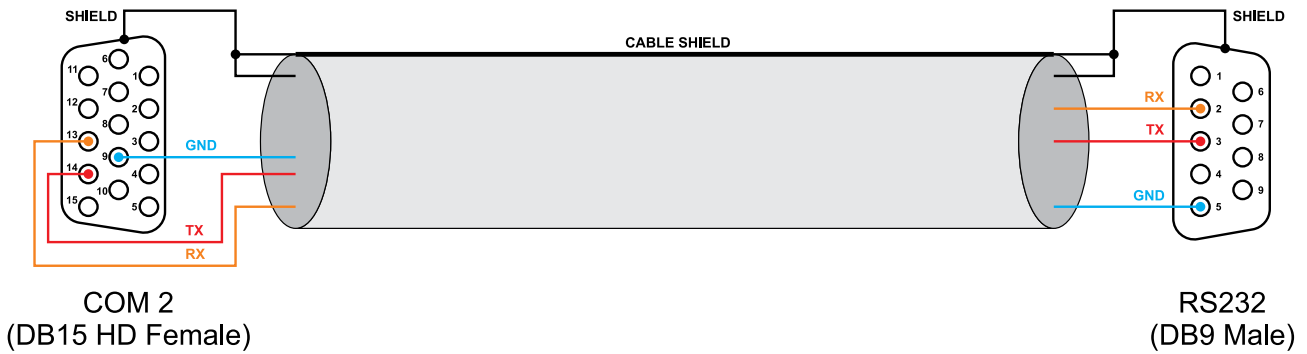

Cable 1

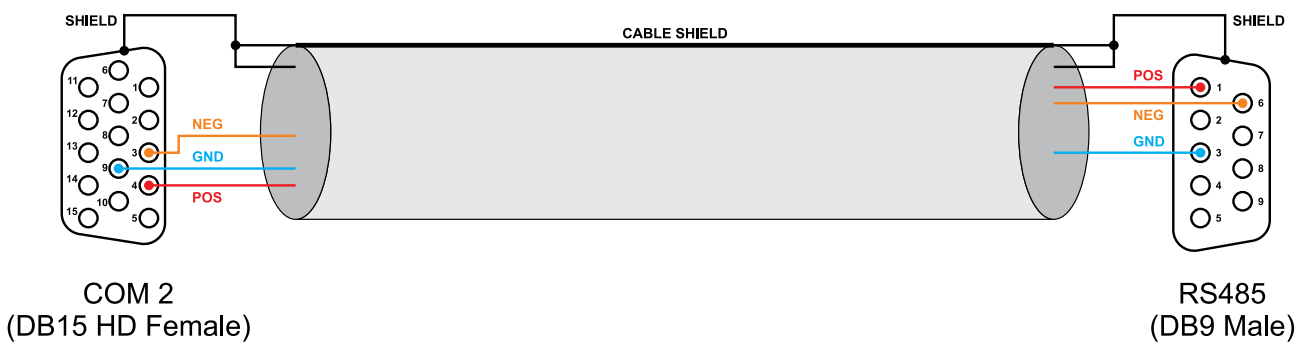

Cable 2

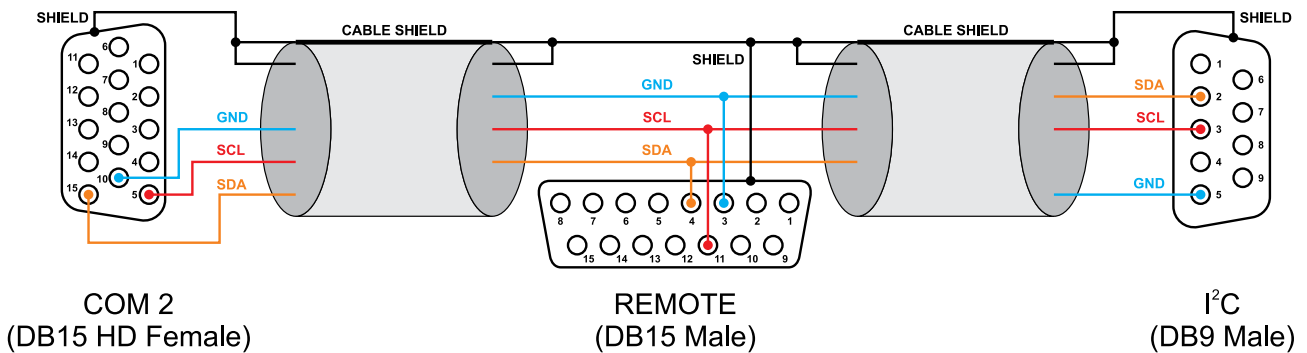

Cable 3

The figure shows two connectors for a connection to the monitored device via I²C. This is just an example. If your installation includes three devices connected via I²C, use three connectors. The figure shows the connection for the two types of connectors used by RVR Electronica as I²C. Combine the number and type of connectors needed for your installation.

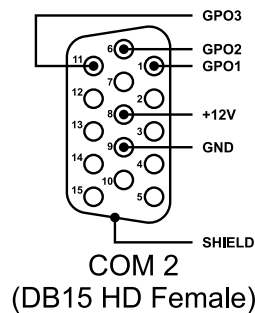

Cable 4

The figure shows the signals for GPO. The DB2003 supply voltage +12V is available on pin 8.

APPENDIX B

CONNECTION INTERFACES USED WITH EACH SERIES

PTX_LCD

Devices from the PTX_LCD series offer two interfaces to connect to DB2003 – I²C bus and RS232. The REMOTE connector, type DB15 must be used for an I²C connection. Use [“Cable 3”](#) (see [“APPENDIX A” on page 54](#)). If you connect multiple devices on the I²C bus, each device must have a unique address. In the device screen menu, under the “General Set” page, the parameter is named “UART Adr.”. The same value is used for the I²C bus address. In the DB2003, it is designated “Bus Address” and is valid for all interfaces.

The RS232 connection can be made in two ways. On the PTX_LCD side, you can use the RS232 connector, type DB9. On the DB2003 side, you can use the COM1 connector and a straight cable, as described in [“APPENDIX A”](#) - [“COM1 Connector”](#). The second way is to use the COM2 connector and [“Cable 1”](#). When 2 devices are connected via RS232 (on COM1 and COM2), they can use the same address value. It is important to set in both DB2003 and PTX_LCD the same values for Bus Address and for Bus Speed.

PTX_DDS and PTX_LCDDSP

Devices from this series use only an RS232 connection and it can be made in two ways. On the PTX_DDS/PTX_LCDDSP side, use the RS232 connector, type DB9. On the DB2003 side, you can use the COM1 connector and a straight cable, as described in [“APPENDIX A”](#) - [“COM1 Connector”](#). The second way is to use DB2003 connector COM2 and [“Cable 1”](#). When 2 devices are connected via RS232 (on COM1 and COM2), they can use the same address value. It is important to set in both DB2003 and PTX_DDS/PTX_LCDDSP the same values for Bus Address and for Bus Speed.

Devices from the PTX_DDS and PTX_LCDDSP series have a REMOTE connector but it cannot be used with the DB2003.

TEX_LCD and Blues

Devices from the TEX_LCD and Blues series use only an I²C bus connection, using the REMOTE connector, usually type DB15. Use [“Cable 3”](#). If you connect multiple devices on the I²C bus, each device must have a unique address.

Devices from the TEX_LCD and Blues series have an RS232 connector but it cannot be used with the DB2003.

PJ Amplifiers

Amplifiers from the PJ series use only an I²C connection. Usually, the connector is of the DB9 type and is designated ‘I²C BUS’. Use [“Cable 3”](#) from [“APPENDIX A”](#). If you connect multiple devices on the I²C bus, each device must have a unique address.

PJ amplifiers have an RS232 connector but it cannot be used with the DB2003.

Plug-In series

Amplifiers from the Plug-in series offer RS485 and RS232 connectivity. For the RS485 connection, use [“Cable 2”](#). The Plug-in connector is positioned on the rear panel of the Control Unit, type DB9 female, designated ‘RS485’.

On the front panel of the Control unit, there is a connector designated RS232. The Plug-in is accessible from this connector, but this is not recommended. Leave this connector available to service the transmitter. These two connectors share the same UART. When RS232 is used, the other connector (RS485) is disabled internally. The DB2003 considers this as Link Loss and if the alarm is enabled, notifications are sent.

APPENDIX C

CONNECTION SCENARIOS

The following pages illustrate examples of installations. The figures show the necessary cables as well as their corresponding connectors. Only the connections to DB2003 are described. To simplify the figures, the remaining connections between the devices, such as power, audio and RF, have been omitted.

The GSM Modem shown in the figures is optional. If it is not present in the figure, this means that COM1 is in use and a Modem can therefore not be used.

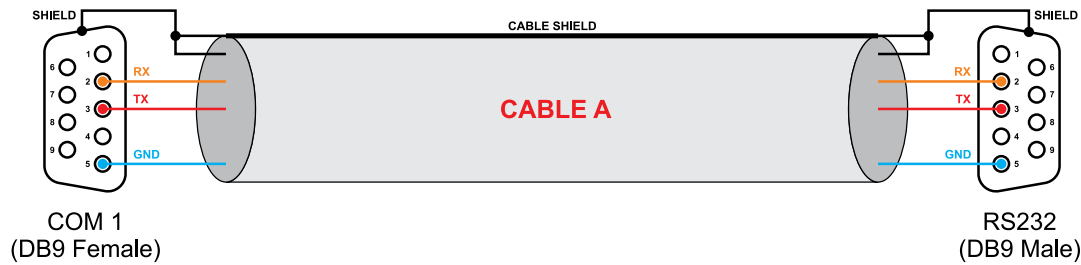

Installation with
PTX-DDS on COM1
(via RS232)

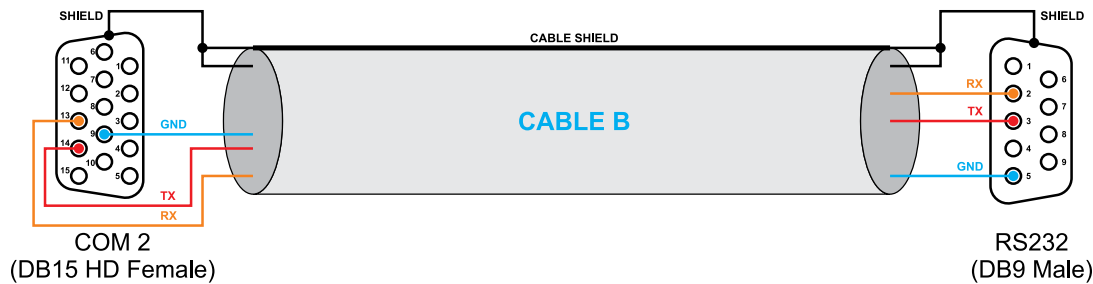
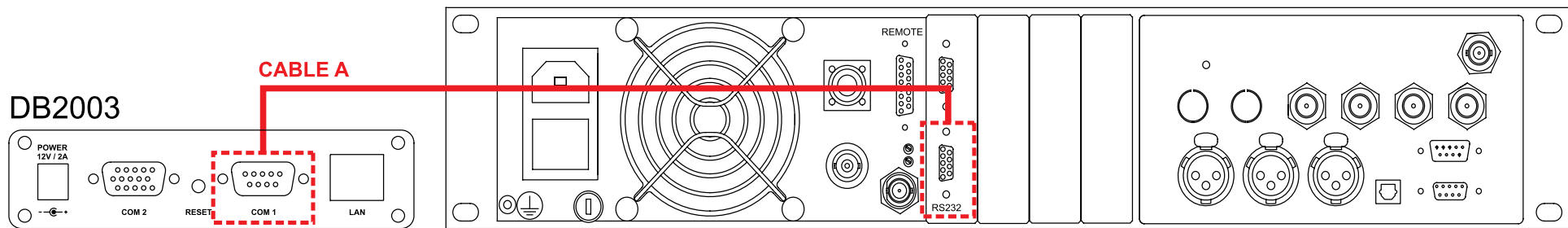

Installation with
PTX-DDS on COM2
(via RS232)

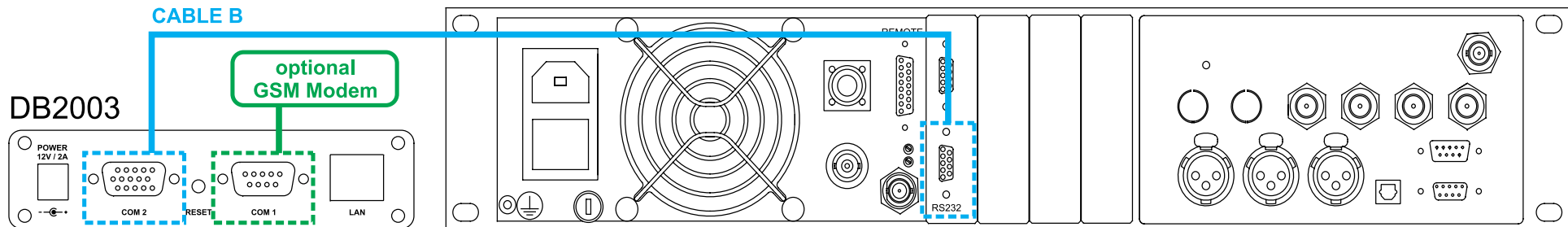

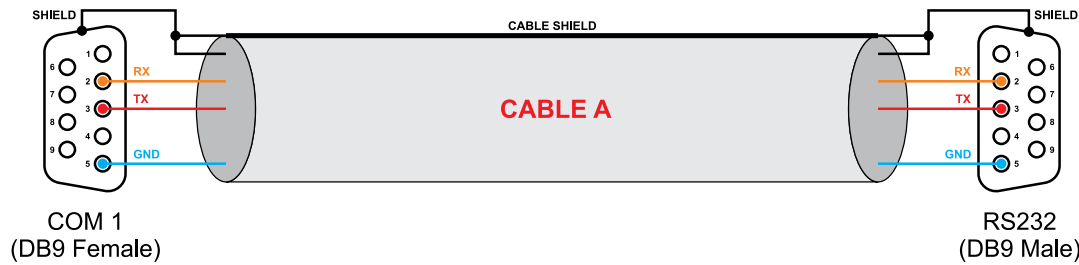

Installation with
PTX-LCD on COM1
(via RS232)

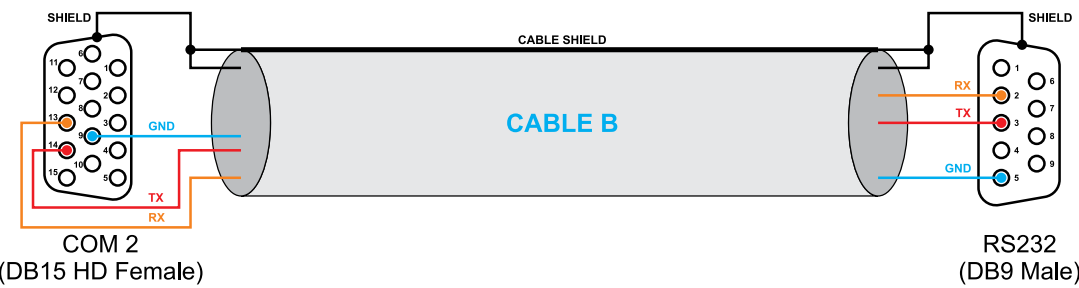
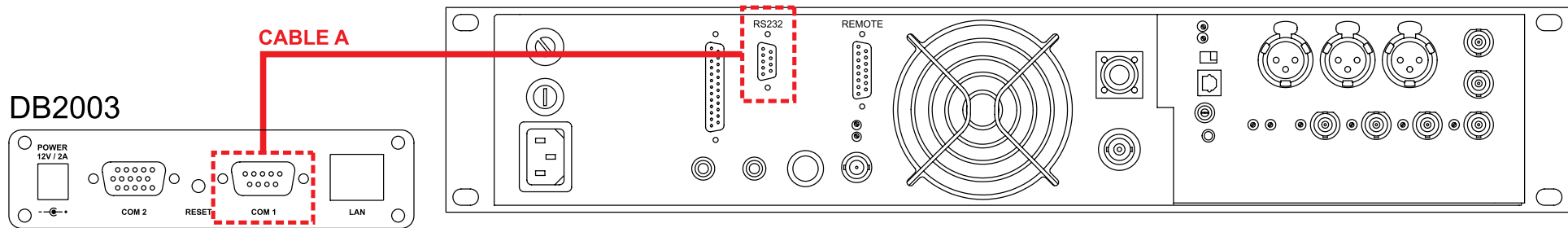

Installation with
PTX-LCD on COM2
(via RS232)

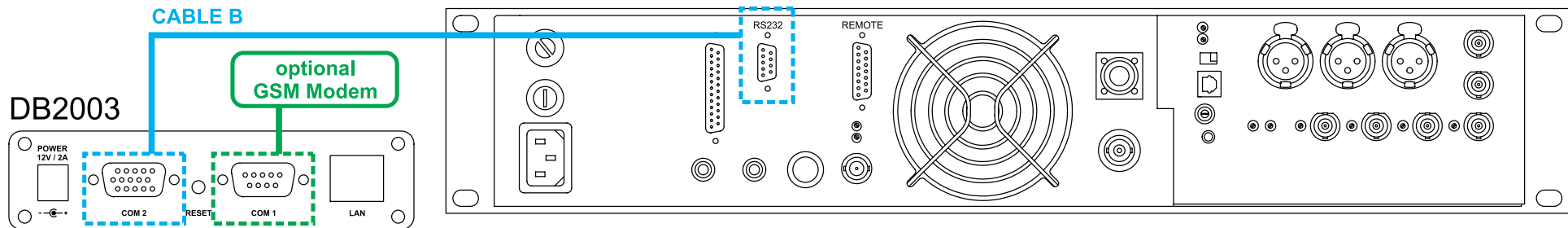

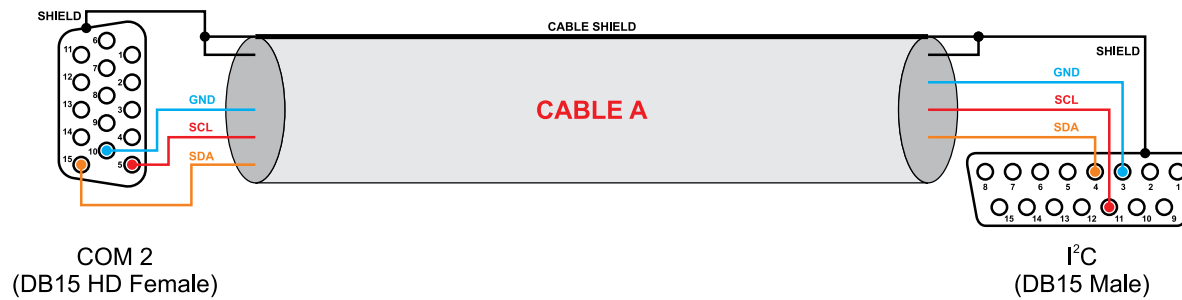

Installation with
PTX-LCD on COM2
(via I²C)

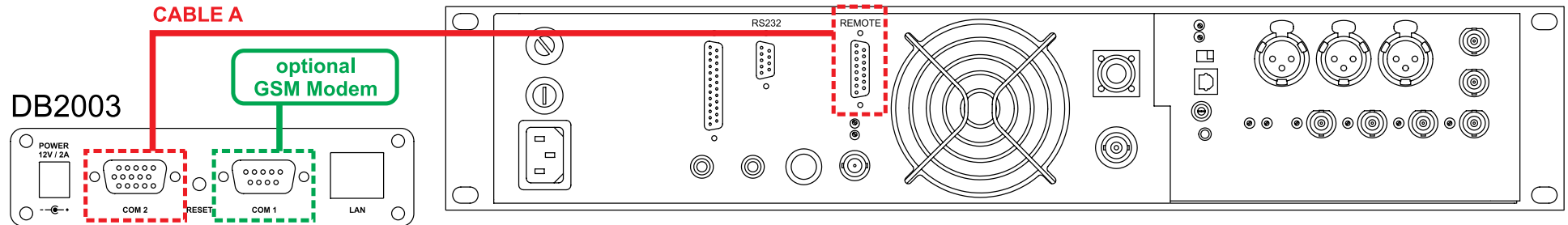

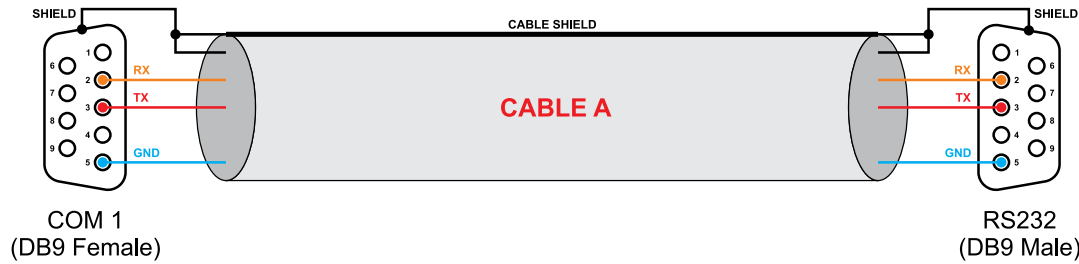

Installation with
PTX-LCDDSP on COM1
(via RS232)

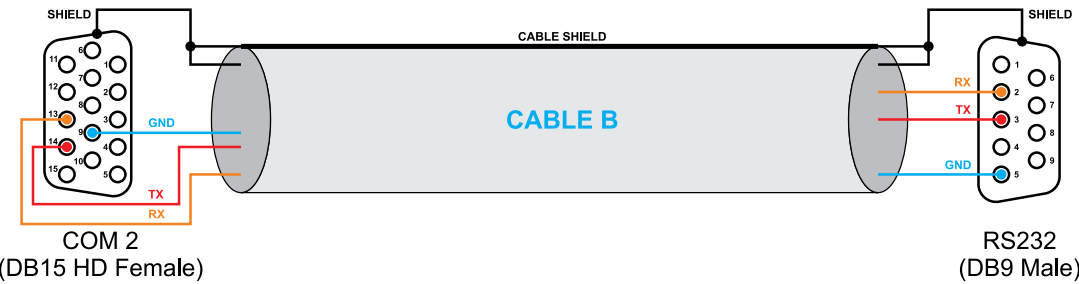
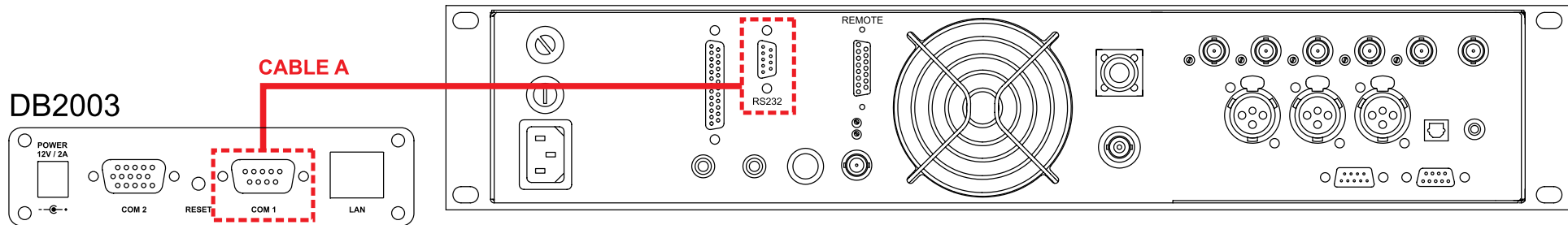

Installation with
PTX-LCDDSP on COM2
(via RS232)

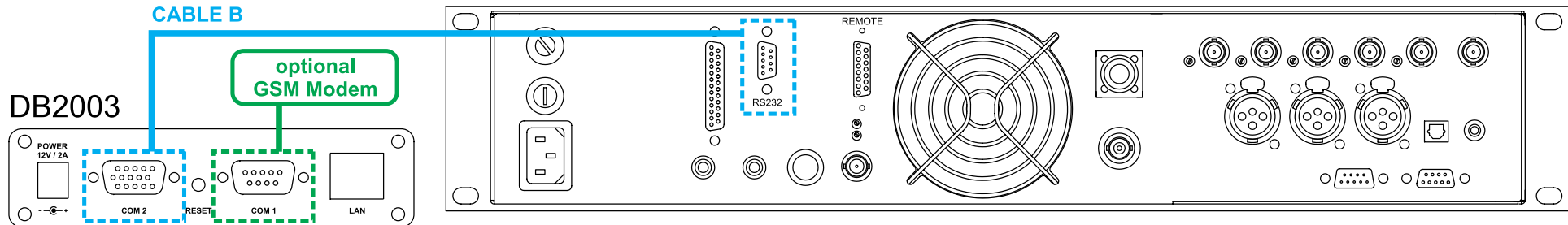

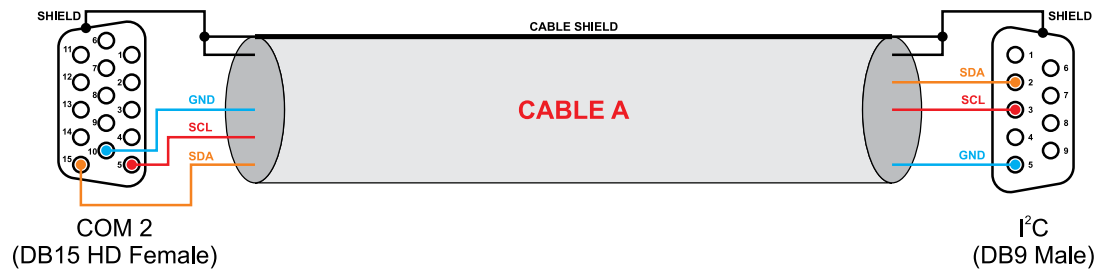

Installation with
PJ 502/702 LCD (2HE)
(via I²C)

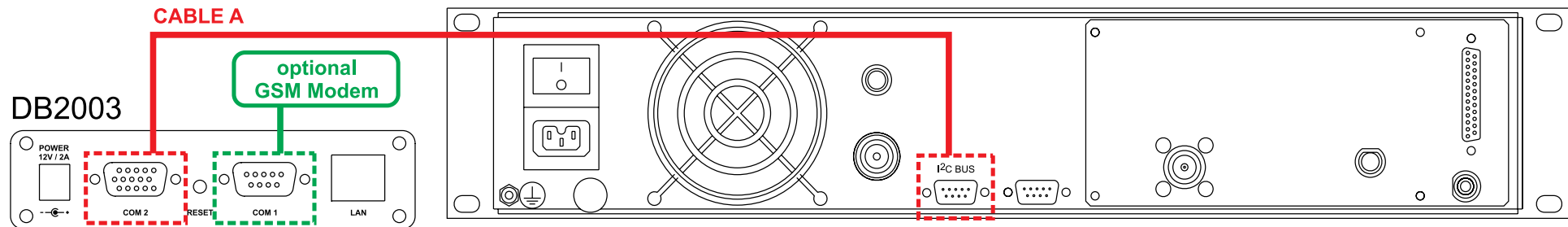

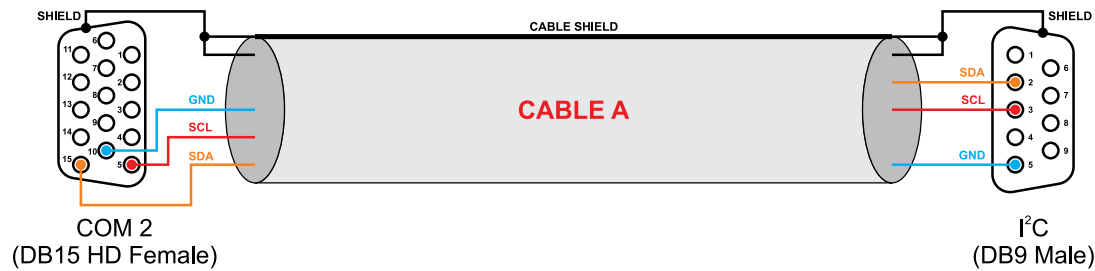

Installation with
PJ 3500 LCD (3HE)
(via I²C)

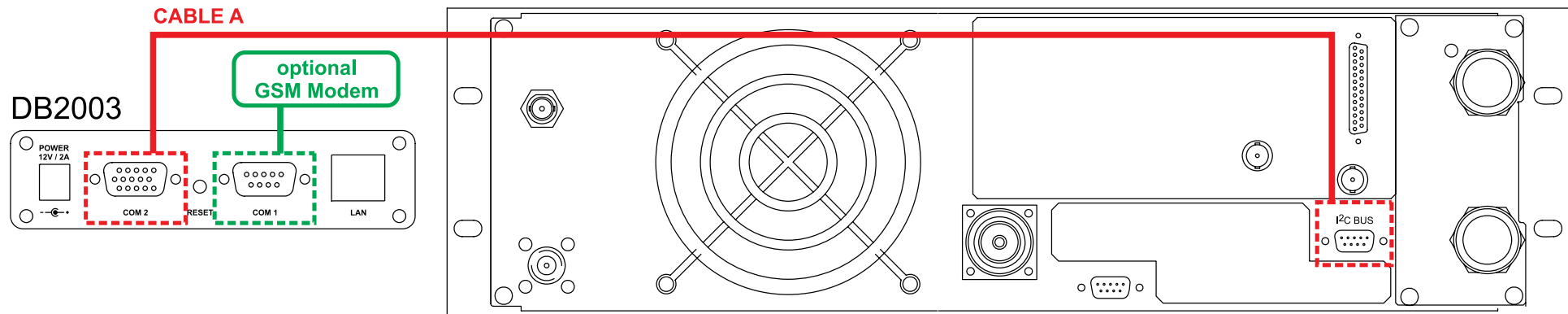

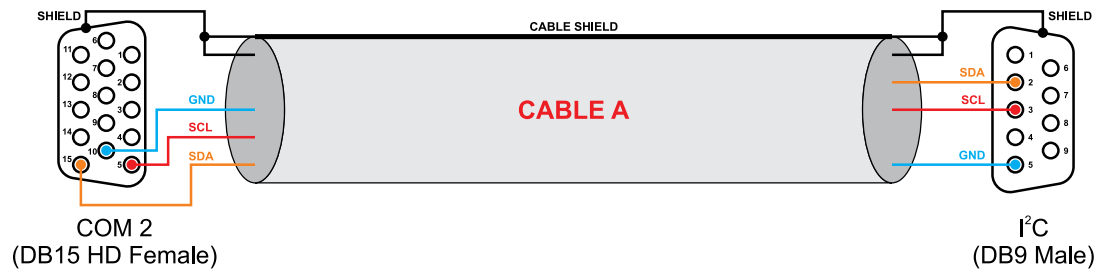

Installation with
PJ 5000 U-K (4HE)
(via I²C)

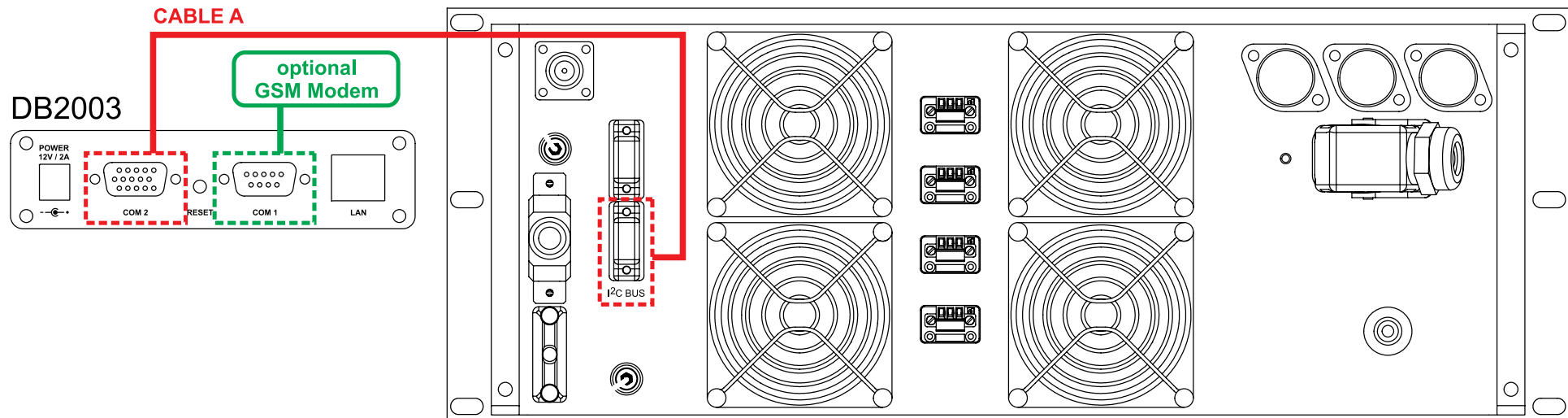

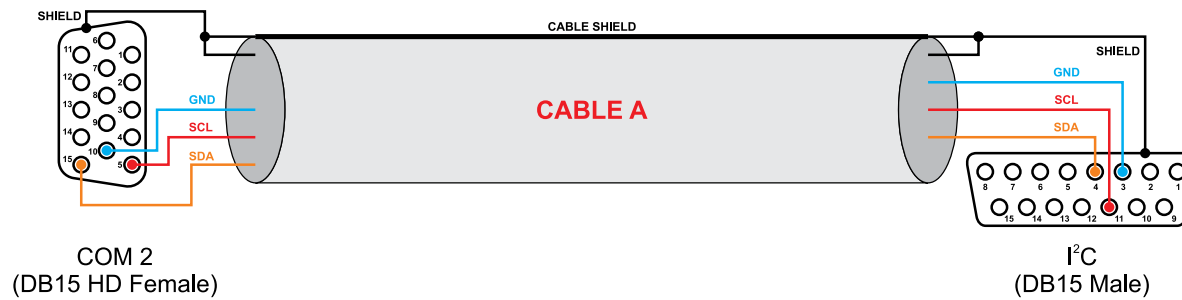

Installation with
TEX-LCD (2HE)
(via I²C)

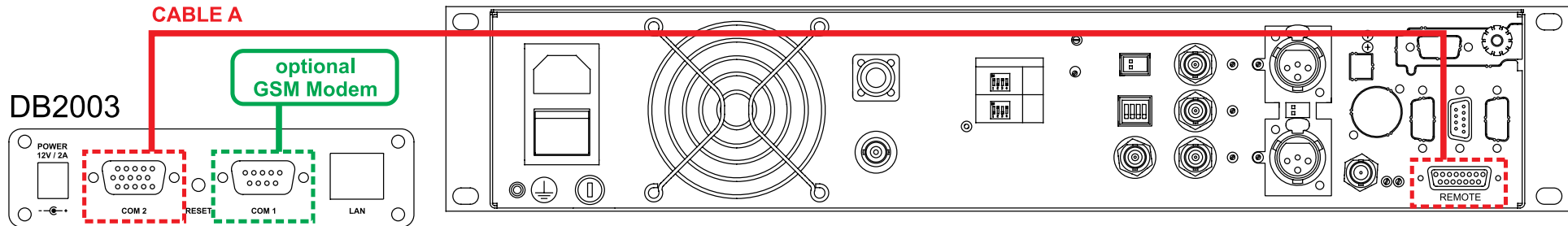

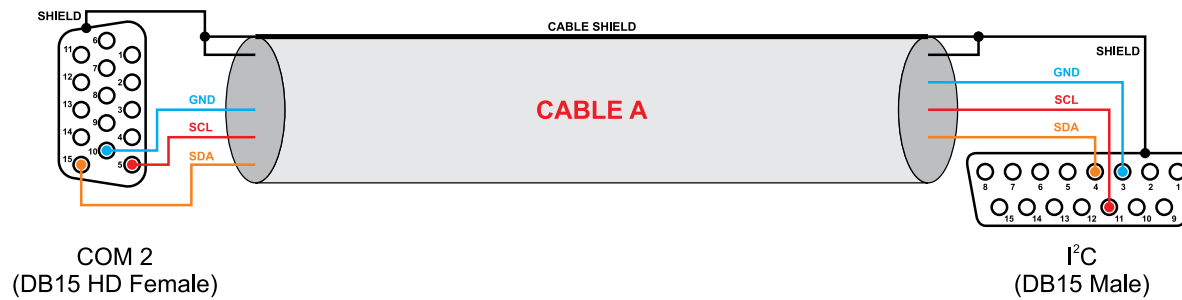

Installation with
TEX-LIGHT (3HE)
(via I²C)

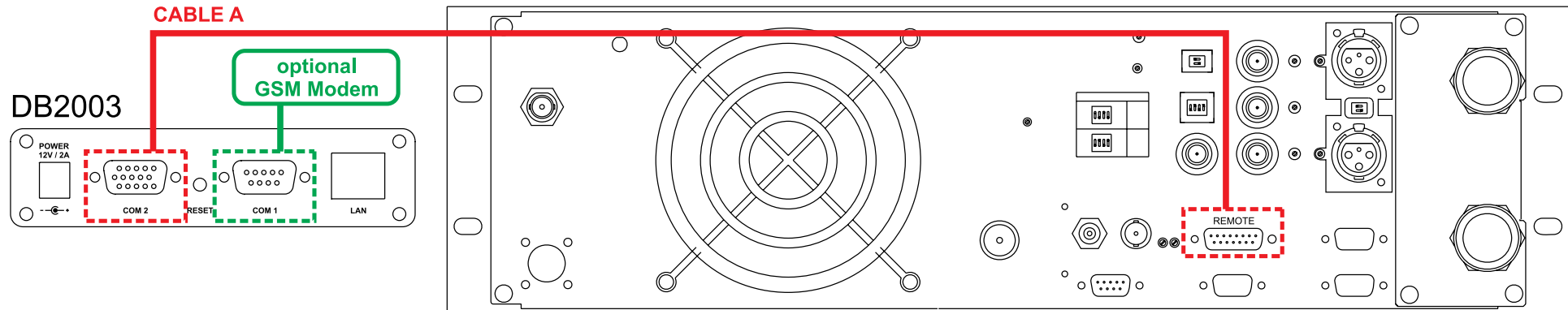

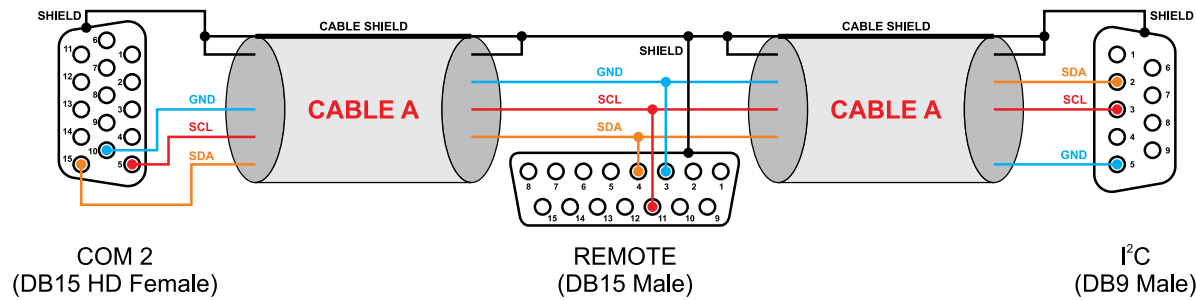

Installation with
one PJ Amplifier and
one Exciter (via I²C)

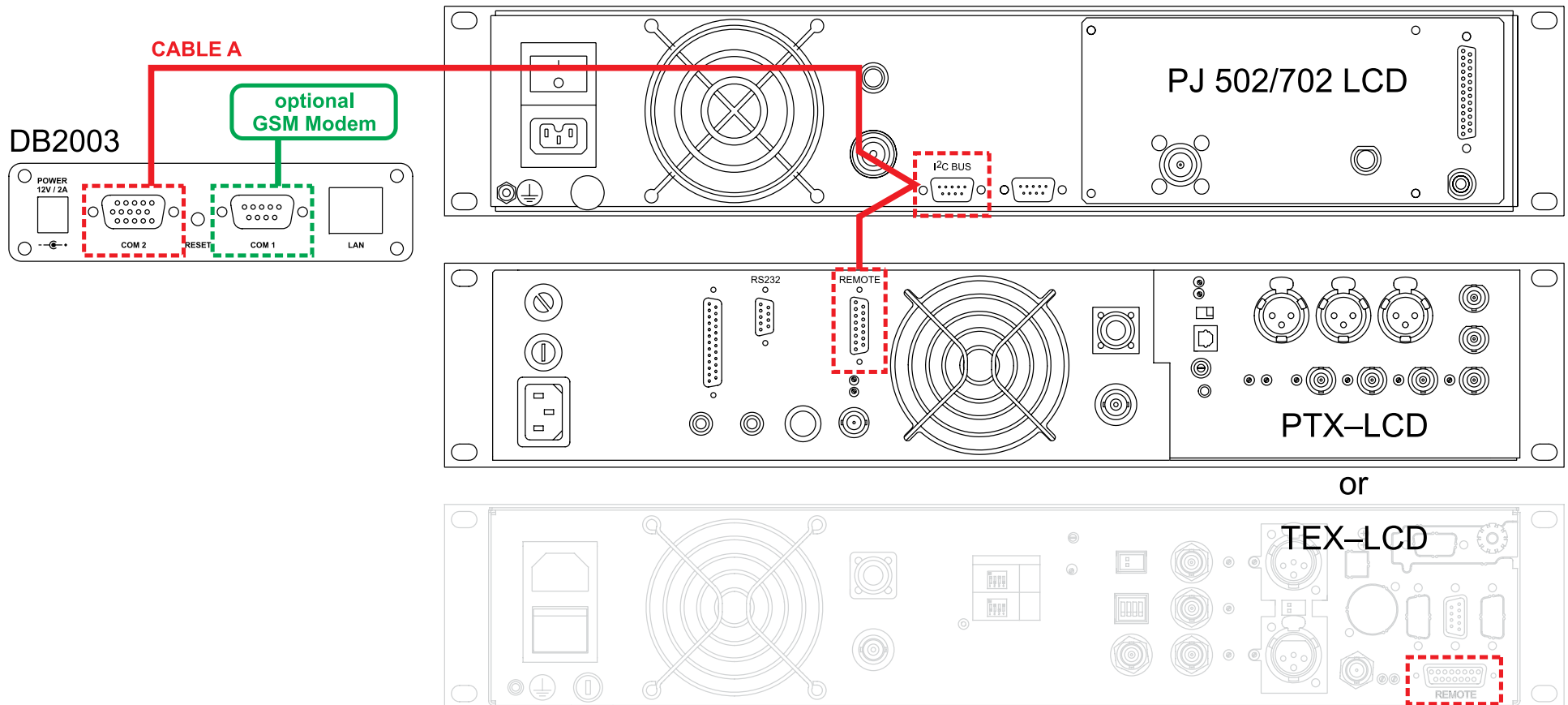

Installation with
one PJ Amplifier and
one Exciter (on COM1 via RS232)

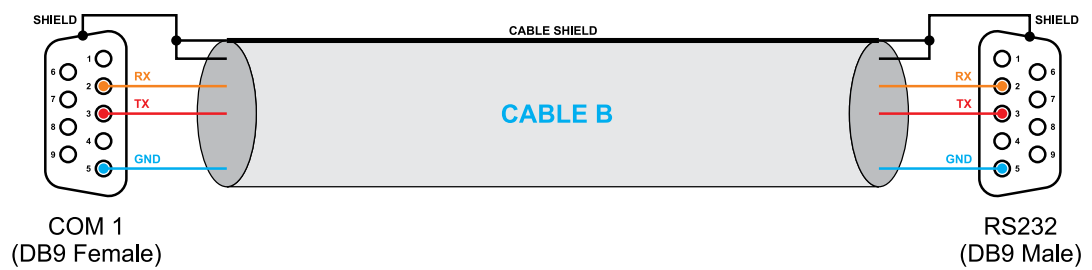
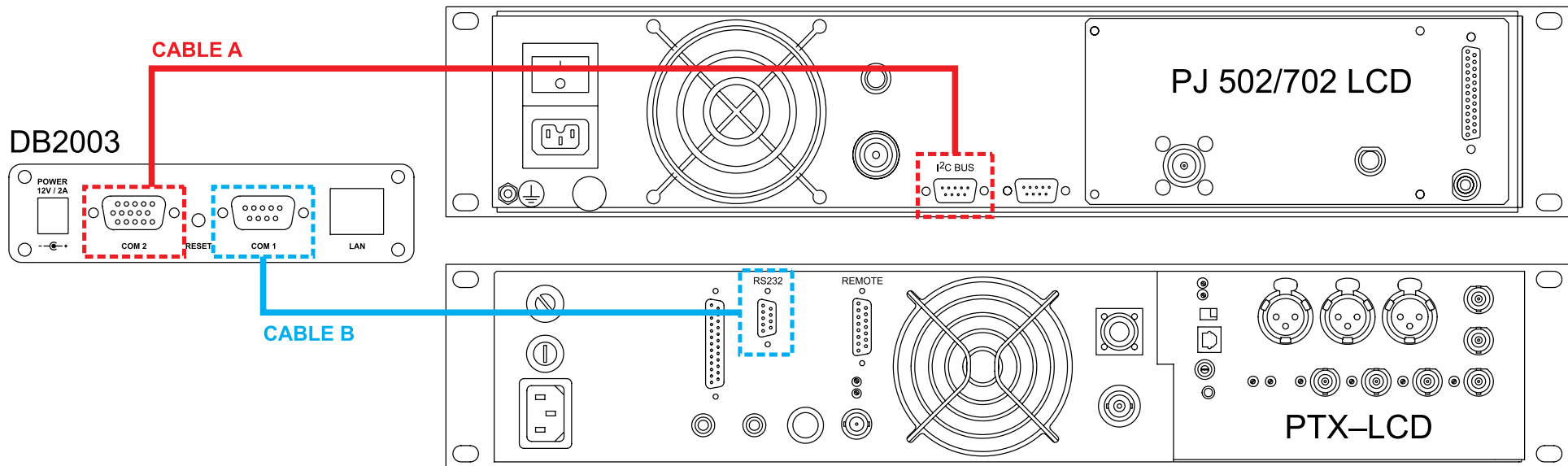
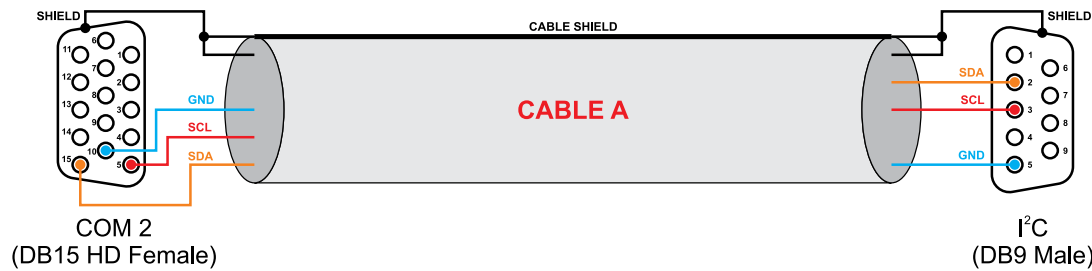

↑
(likewise for PTX-DDS or PTX-LCDDSP)

Installation with
one PJ Amplifier and
one Exciter (on COM2 via RS232)

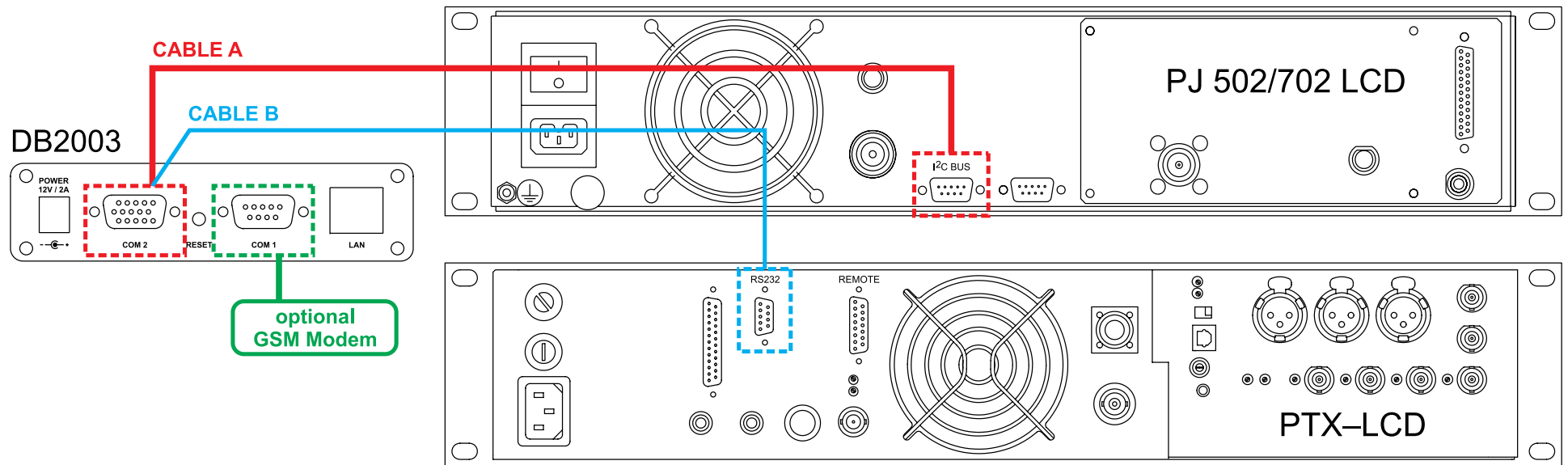

↑
(likewise for PTX-DDS or PTX-LCDDSP)

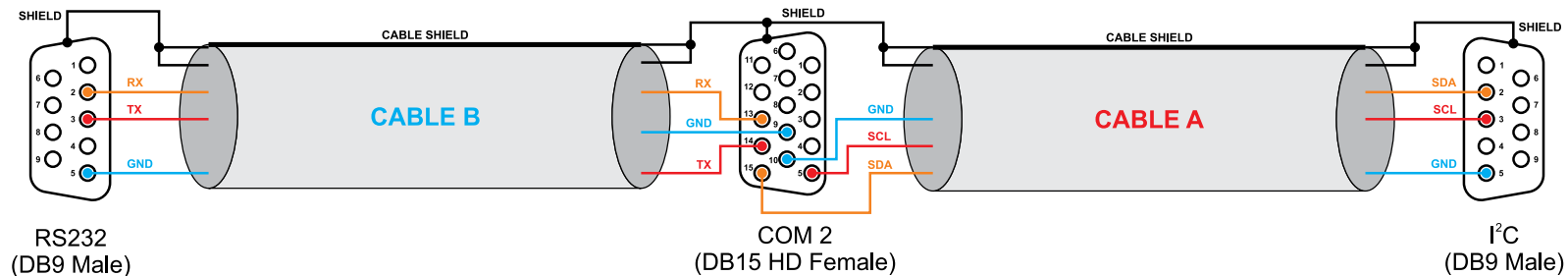

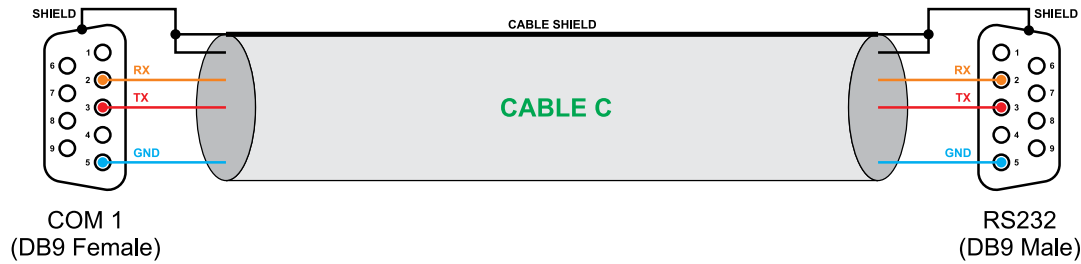

Installation with
one PJ Amplifier and
two Exciters

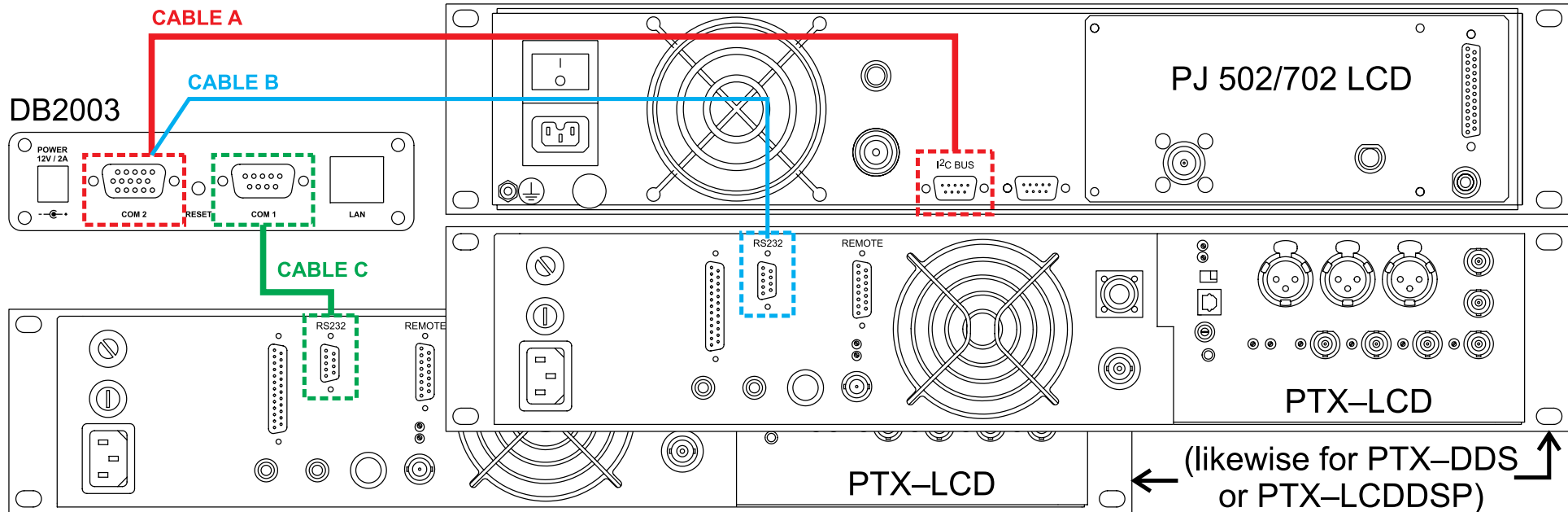
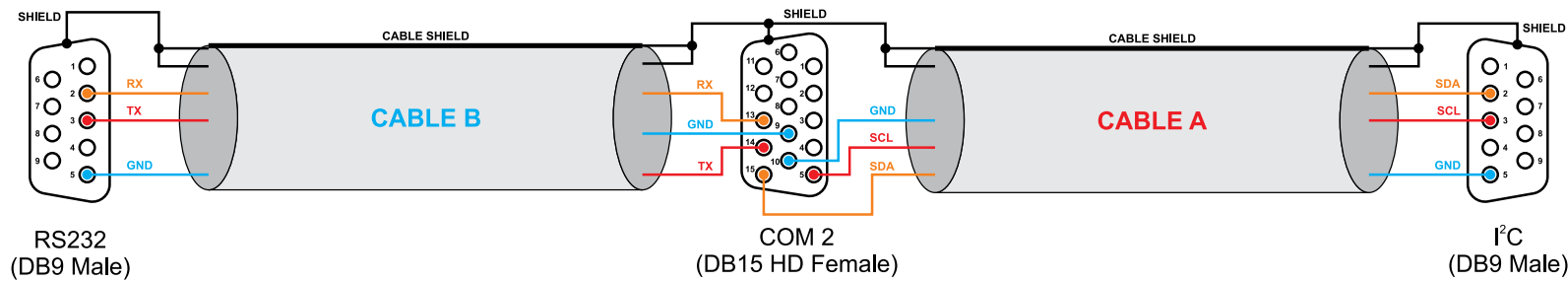

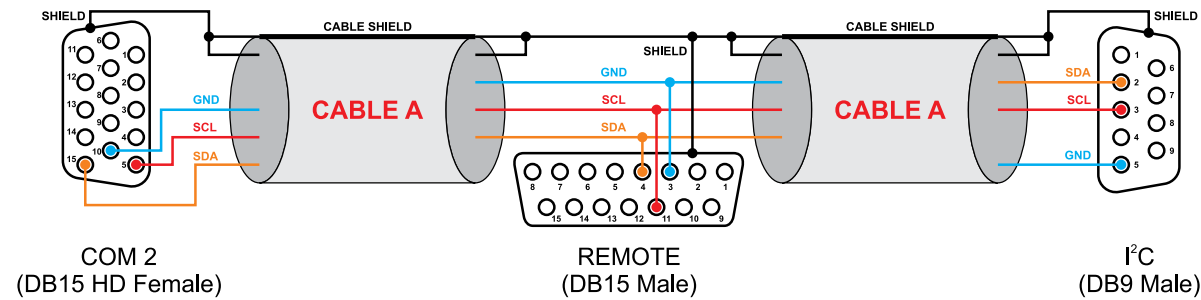

COM 2
(DB15 HD Female)

REMOTE
(DB15 Male)

I²C
(DB9 Male)

Installation with
one PJ Amplifier and
two Exciters

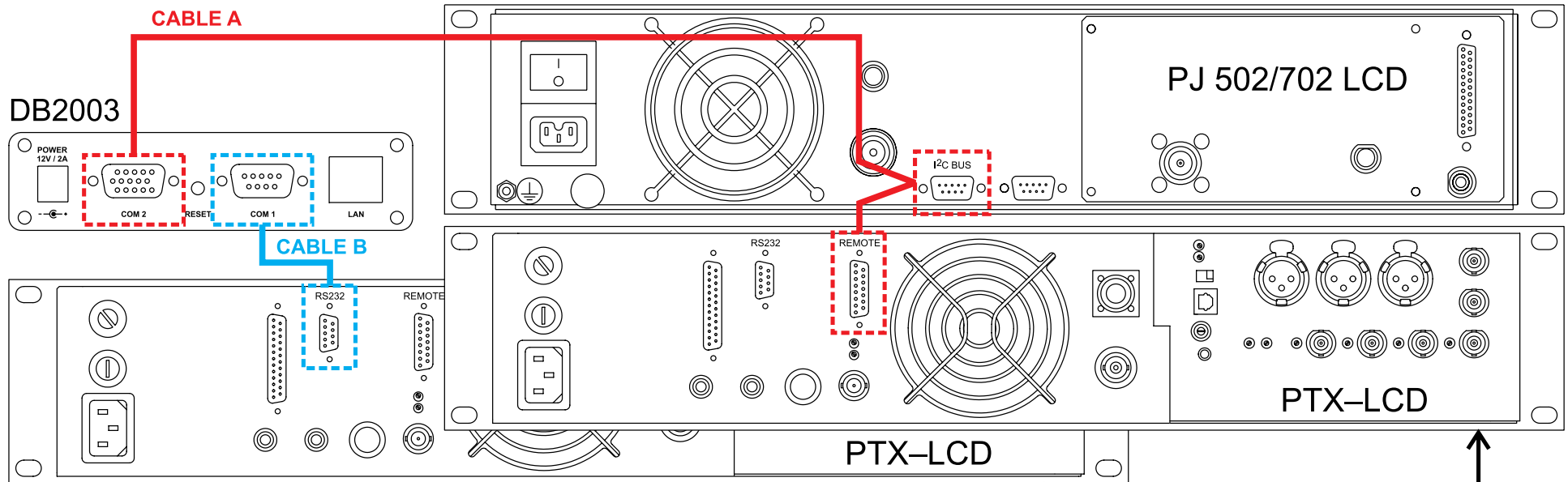

DB2003

PJ 502/702 LCD

PTX-LCD

PTX-LCD

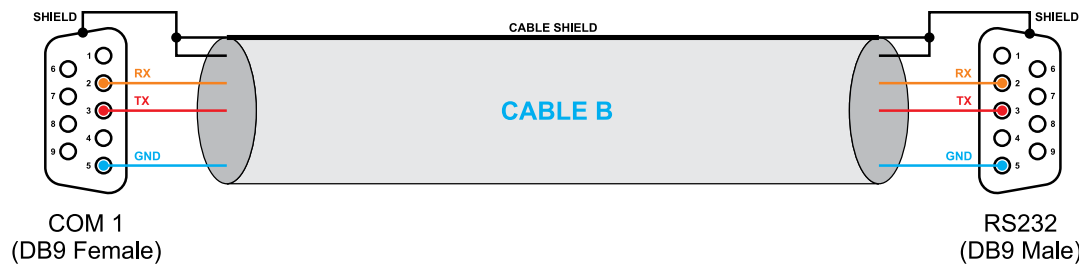

COM 1
(DB9 Female)

RS232
(DB9 Male)

(likewise for
PTX-DDS
or PTX-LCDDSP)

(likewise for
TEX-LCD
or Blues)

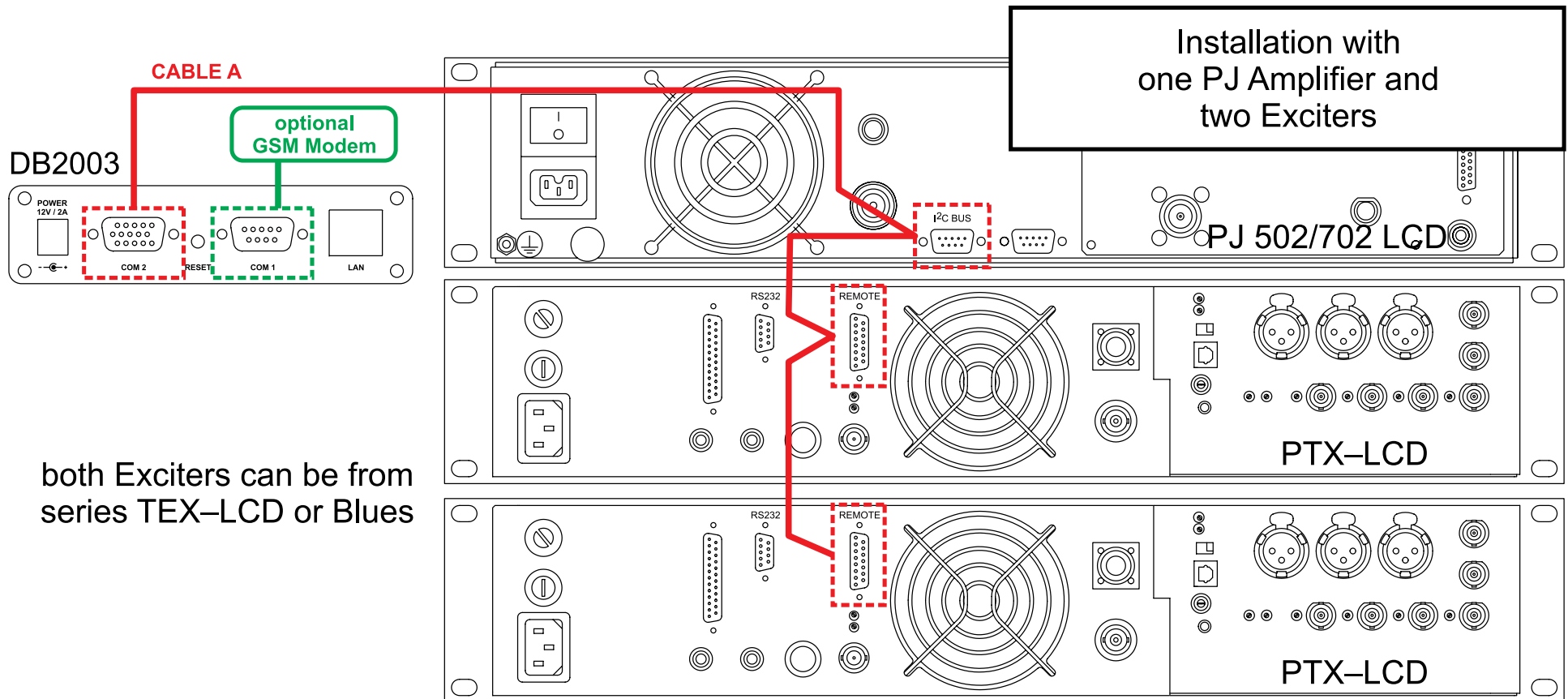

both Exciters can be from series TEX-LCD or Blues

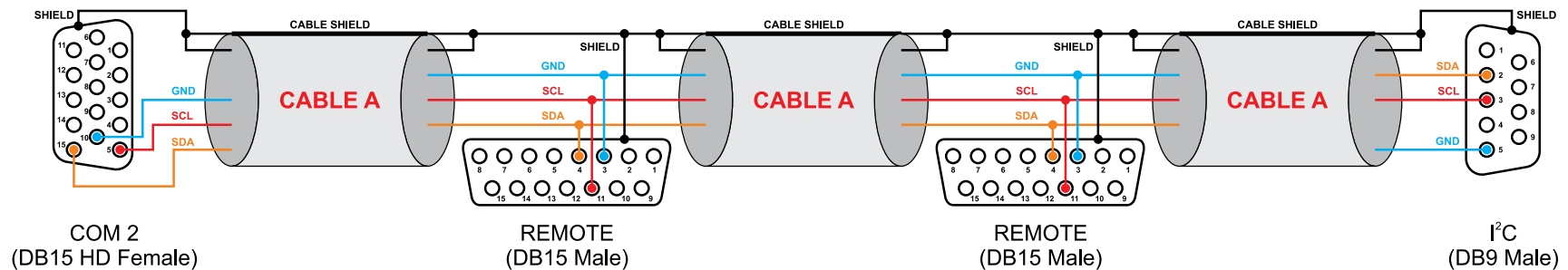

Installation with
two PJ Amplifiers and
one Exciter

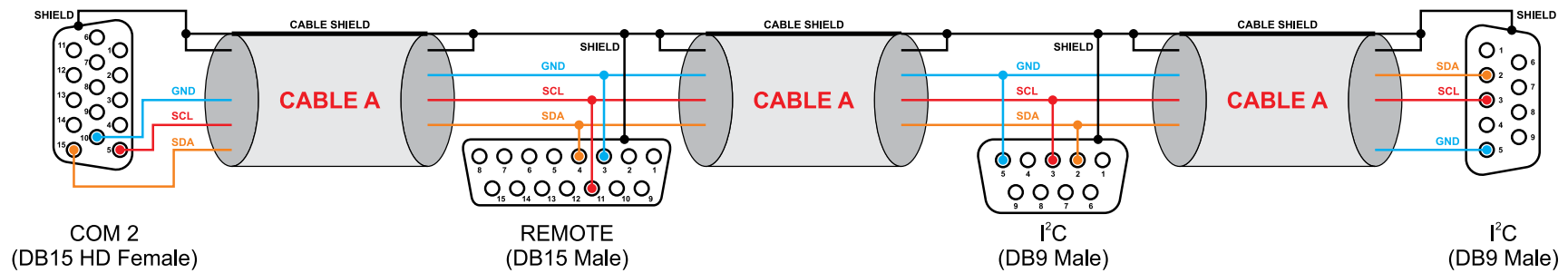
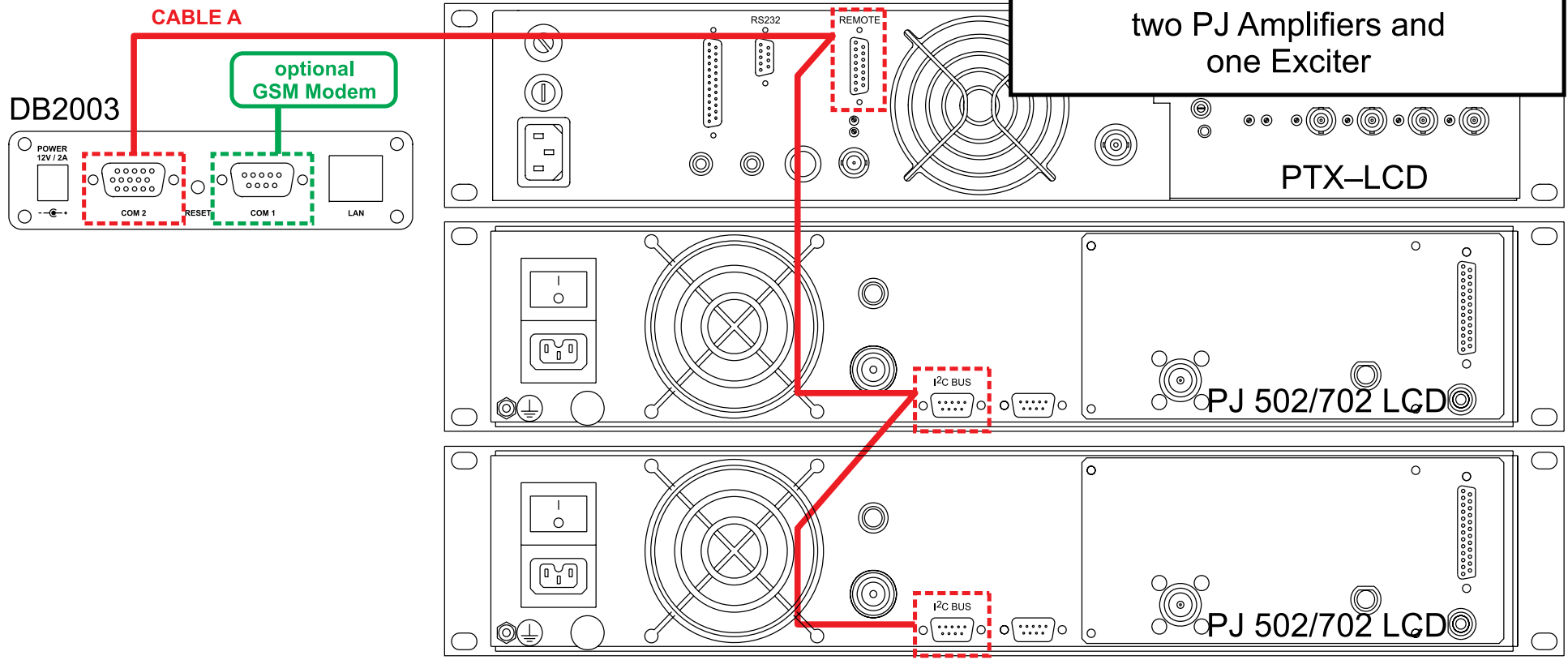

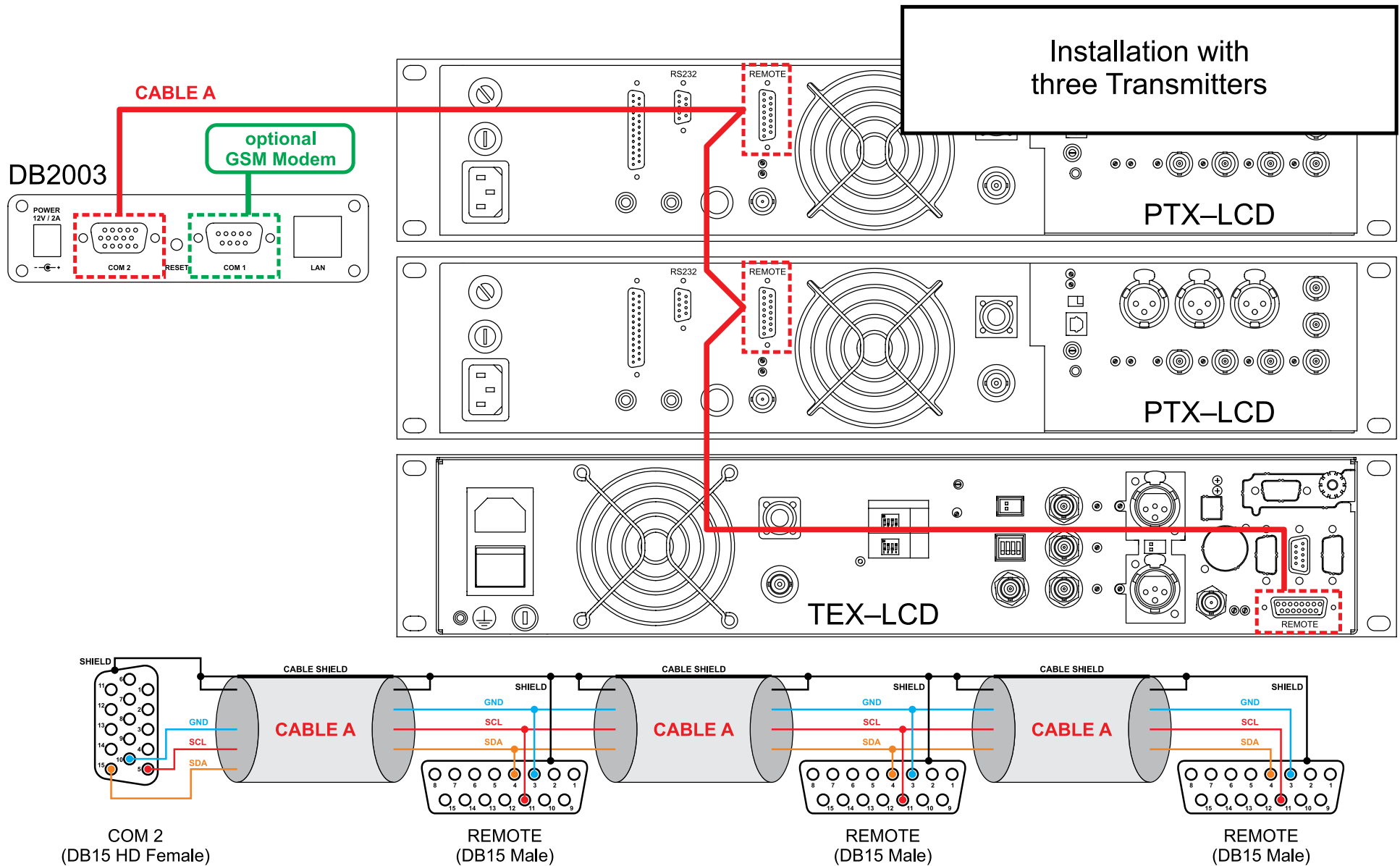

WARRANTY TERMS AND CONDITIONS

I. TERMS OF SALE: DEVA Broadcast Ltd. products are sold with an understanding of “full satisfaction”; that is, full credit or refund will be issued for products sold as new if returned to the point of purchase within 30 days following their receipt, provided that they are returned complete and in an “as received” condition.

II. CONDITIONS OF WARRANTY: The following terms apply unless amended in writing by DEVA Broadcast Ltd.

A. The Warranty Registration Card must be completed and returned to DEVA Broadcast Ltd. within 10 days of delivery. Product registration can also be done digitally at <https://www.devabroadcast.com/members/product-registration>, after registering on our website, within 10 days of delivery.

B. This Warranty applies only to products sold “as new.” It is extended only to the original end-user and may not be transferred or assigned without prior written approval by DEVA Broadcast Ltd.

C. This Warranty does not apply to damage caused by improper mains settings and/or power supply.

D. This Warranty does not apply to damage caused by misuse, abuse, accident or neglect. This Warranty is voided by unauthorized attempts at repair or modification, or if the serial identification label has been removed or altered.

III. TERMS OF WARRANTY: DEVA Broadcast Ltd. products are warranted to be free from defects in materials and workmanship.

A. Any discrepancies noted within TWO YEARS of the date of purchase will be repaired free of charge, or the equipment will be replaced with a new or remanufactured product at DEVA Broadcast Ltd. option.

B. Parts and labor for factory repair required after the two-year Warranty period will be billed at prevailing prices and rates.

IV. RETURNING GOODS FOR FACTORY REPAIR:

A. Equipment will not be accepted for Warranty or other repair without a Return Material Authorization (RMA) number issued by DEVA Broadcast Ltd. prior to its return. An RMA number may be obtained by placing an RMA request at <https://www.devabroadcast.com/rma>. The number should be prominently marked on the outside of the shipping carton.

B. Equipment must be shipped prepaid to DEVA Broadcast Ltd. Damage sustained as a result of improper packing for return to the factory is not covered under terms of the Warranty and may occasion additional charges.

V. UPDATES TO THE TERMS OF SERVICE:

For the most up-to-date, valid, and accurate terms, conditions, and product documentation, please visit the official DEVA Broadcast Ltd. website downloads section at <https://www.devabroadcast.com/downloads/deva-documents>. Printed documents may not reflect recent amendments. Reviewing the current online versions ensures you have the latest information.



PRODUCT REGISTRATION CARD

- All fields are required, or warranty registration is invalid and void

Your Company Name _____

Contact _____

Address Line 1 _____

Address Line 2 _____

City _____

State/Province _____ ZIP/Postal Code _____

Country _____

E-mail _____ Phone _____ Fax _____

Which DEVA Broadcast Ltd. product did you purchase? _____

Product Serial # _____

Purchase date ____ / ____ / ____ Installation date ____ / ____ / ____

Your signature*

*Signing this warranty registration form you are stating that all the information provided to DEVA Broadcast Ltd. are truth and correct. DEVA Broadcast Ltd. declines any responsibility for the provided information that could result in an immediate loss of warranty for the above specified product(s).

Privacy statement: DEVA Broadcast Ltd. will not share the personal information you provide on this card with any other parties.