

MAINTENANCE AND OPERATION
INSTRUCTION MANUAL

DB6400

Advanced FM and Digital Radio
4-Band Audio Processor
with Backup Audio Player



Contents

Introduction	6
Typographic conventions	7
General Information	8
Product Features	9
<i>Technical Specifications</i>	<i>10</i>
Front Panel	12
<i>OLED Display</i>	<i>12</i>
<i>LED Meters</i>	<i>12</i>
<i>Context-sensitive Soft Buttons</i>	<i>12</i>
<i>Navigational Buttons</i>	<i>12</i>
<i>Rear Panel</i>	<i>13</i>
<i>Rear Panel Alarm Terminal</i>	<i>14</i>
<i>GPI Trigger Input Pins</i>	<i>14</i>
<i>Digital I/O Pins</i>	<i>14</i>
Safety Warning	15
Operating Recommendations	16
Unpacking and inspection	17
Mounting	17
<i>Rack Requirements 1U</i>	<i>17</i>
<i>Rack Requirements Compact Units</i>	<i>17</i>
<i>Stand-Alone Devices</i>	<i>17</i>
AC Mains Power	18
<i>Fuse holder</i>	<i>18</i>
<i>Mains Voltage Selector</i>	<i>18</i>
<i>Power cord</i>	<i>18</i>
<i>Ground Loops</i>	<i>18</i>
DB6400 Location	19
Source Material Quality	19
Getting Started	20
<i>Connection</i>	<i>20</i>
<i>Network Settings</i>	<i>21</i>
<i>Network Discovery</i>	<i>21</i>
<i>Network Security Recommendations</i>	<i>22</i>
Operation	23
<i>Processing path</i>	<i>23</i>
<i>Audio Processing Explained</i>	<i>24</i>
Basic Setup/Connection Example	25
<i>Referencing Analog and Digital Inputs level</i>	<i>25</i>
<i>Referencing Analog and Digital Outputs level</i>	<i>26</i>
<i>Setup with Analog Program Inputs</i>	<i>27</i>
<i>Setup with Digital Program Inputs</i>	<i>28</i>
<i>Analog connection with two transmitters</i>	<i>29</i>
<i>Analog connection with DEVA SmartGen 6.0</i>	<i>30</i>
<i>Side-chain</i>	<i>30</i>
<i>Loop through</i>	<i>31</i>

OLED Display, Navigational & Soft Buttons	32
<i>OLED Display</i>	32
<i>Header area</i>	32
<i>Main Screen working area</i>	33
<i>Soft Buttons</i>	33
<i>Navigation Buttons</i>	33
<i>Menu Pages</i>	34
<i>[Input]</i>	34
<i>[Process]</i>	34
<i>[Output]</i>	34
<i>[Presets]</i>	34
Settings.....	40
<i>Trigger ports</i>	40
<i>Keyboard lock</i>	41
<i>Keyboard unlock</i>	41
<i>RDS</i>	42
<i>Dayparting</i>	42
Other sections	43
<i>Stereo</i>	43
<i>Status</i>	43
Factory and User presets.....	44
<i>Factory Presets</i>	44
<i>How to create and save a User Preset or How to customize your sound</i>	44
WEB Interface.....	46
<i>Manual IP Address Identification</i>	46
<i>Network Discovery</i>	47
<i>Access</i>	47
<i>Status</i>	48
<i>Settings</i>	49
<i>General</i>	49
<i>Communication</i>	50
<i>Network</i>	50
<i>SNMP Agent</i>	50
<i>E-mail</i>	50
<i>HTTP Server</i>	51
<i>FTP Server</i>	51
<i>Syslog</i>	51
<i>Dayparts</i>	52
<i>Other</i>	53
<i>Firmware Update</i>	53
<i>Storage</i>	53
<i>System Log</i>	53
<i>Factory Defaults</i>	53
<i>Reboot</i>	53
<i>Log</i>	54
<i>Presets</i>	55
<i>How can a user preset be made?</i>	55
<i>Preset Lock</i>	56

<i>Presets Export</i>	56
<i>Presets Import</i>	57
<i>Presets Delete</i>	57
<i>Input</i>	58
<i>AGC</i>	60
<i>Equalizer</i>	62
<i>Enhancer</i>	63
<i>Multiband 1 (Multiband Limiter)</i>	64
<i>Multiband 2 (Multiband Limiter)</i>	66
<i>Final Limiter</i>	67
<i>MPX</i>	68
<i>RDS Data</i>	69
<i>Basic RDS</i>	69
<i>Dynamic RDS</i>	71
<i>How to connect to the RDS Console</i>	73
<i>RDS Console syntax</i>	73
<i>List of available RDS console commands and their responses</i>	74
<i>Output</i>	75
APPENDIX A	76
<i>RDS: Europe vs America</i>	76
<i>The RDS System</i>	76
APPENDIX B.1	77
<i>PTY Code Description Used in RBDS Mode – North America</i>	77
APPENDIX B.2	78
<i>PTY Code Description Used in RDS Mode – Europe, Asia</i>	78
APPENDIX C	79
<i>How should I configure the connection between my DEVA Device and an FTP Client?</i>	79
1. <i>FTP Server Settings</i>	79
2. <i>IP Router and Port Translation Settings</i>	79
3. <i>Example of FTP Client (FileZilla) Settings</i>	80
WARRANTY TERMS AND CONDITIONS	81
Product Registration Card	82

THIS PAGE
IS INTENTIONALLY
LEFT BLANK

Introduction

DEVA Broadcast Ltd. is an international communications and high-technology manufacturing organization, its corporate headquarters and facility located in Burgas, Bulgaria. The company serves the broadcast and corporate markets worldwide – from consumers and small businesses to the largest global organizations. It is dedicated to the research, design, development and provision of advanced products, systems and services. DEVA Broadcast launched its own brand back in 1997 and has nowadays evolved to become known as a market leader and internationally reputed manufacturer of user-friendly, cost-effective and innovative broadcast products.

Creativity and innovation are deeply woven into DEVA Broadcast corporate culture. Through successful engineering, marketing and management our team of dedicated professionals creates future-oriented solutions to improve customers' performance. You may rely that all issues communicated to our crew would be addressed accordingly. We pride ourselves on our pre and post-sales support and purchase services, which along with the outstanding quality of our radio gear have won us due respect and the market authority position.

DEVA Broadcast best-of-breed solutions have become the best sellers for our partners. The strategic partnerships which have been formed with industry leaders during all these years that we have been operating on the broadcasting market, have proved us a reliable business partner and a valuable asset, as our dealers worldwide would confirm. In constant pursuit of precision and long-term satisfaction, DEVA Broadcast enhances the reputation of our partners and clients alike. Furthermore, we have already a proven merit as a credible partner provider.

Our portfolio offers complete line of high quality and competitive products for FM and Digital Radio, Radio Networks, Telecommunication Operators and regulation authorities. For almost two decades of intensive software and hardware development, we have achieved a unique price-performance and endurance of our product lines. Our company's multitude of equipment and services is in line with the latest technologies and key trends. The most recognizable characteristics attributed to DEVA Broadcast products are their clear-cut, streamlined design, easiness of use and cost-effectiveness: simplicity of forms but multiplicity of functions.

For us there is no stage when we deem that we have reached the most satisfactory level in our work. Our engineers are in constant pursuit of new ideas and technologies to be captured in DEVA Broadcast solutions. Simultaneously, a strict control is being exercised at each step of any new development. Experience and hard work are our fundament but the continuous improving process is what we never leave aside. DEVA Broadcast participates on a regular basis in all landmark broadcasting events, not only to promote its products, but to exchange valuable know-how and experience. We are also engaged in international large-scale projects involving radio and audio solutions which makes us even more competitive on the global market.

All DEVA Broadcast products are developed and produced in accordance with the latest ISO 9001 quality control standards.

Typographic conventions

The following table describes important conventions used in the manual.

Convention and Style	Description	Examples
<i>Menu > Sub Menu > Menu Command</i>	A menu item(s) and menu command that you need to click in sequence	Click <i>Settings > General</i>
[Button]	Interface Interactive buttons	Press [OK] to save the changes
NOTE	Important notes and recommendations	NOTE: The notification will appear only once
<u>“Reference Name” on Page XXX</u>	References and links	refer to <u>“New Connection”</u> (see <u>“Monitoring” on page 56</u>)
Example	Used when example text is cited	Example for E-mail Notification: Date: 04 Nov 2013, 07:31:11

General Information

The long years of experience at the top level of broadcasting technologies, as well as the undisputable expertise of our engineering team have brought forth a brand new audio processing tool - the DB6400 FM and Digital Radio 4-Band Audio Processor.

The DSP-based Stereo Encoder guarantees precision of the MPX signal with advanced peak control and two independently-configurable composite MPX outputs. The DB6400 offers perfect audio clarity no matter what the source material is. A complete processing architecture: Wide band AGC with “Intelligent Gating”, 4-band Parametric EQ, Advanced Bass and Treble Controls, 4-Band High Quality Sound processor with Fidelity control and Sound Impact, 4-Band Limiter, FM Limiter with advanced distortion & pre-emphasis control and HD Lookahead Limiter.

Another feature that distinguishes the DB6400 from other products of its category is its Fallback function. This cutting-edge device is able to detect signal loss. In the case of silence at the main audio input, it automatically switches over to a backup source, thus ensuring a constant audio feed. What is more, an e-mail notification is immediately sent which allows for an instant response on the part of your technical support team. Through the use of a standard FTP client, you have the opportunity to update the backup content at will via any PC. An additional asset is the automatic return to the main audio source as soon as the default input is restored. All silence sense parameters are user-defined.

Needless to say, the DB6400 comes with a user-friendly, comprehensive and well-organized user interface. Access is available through the front panel, remotely via TCP/IP and by using the WEB interface through iOS, Android or any other mobile device.

This one-of-a-kind device is the peak of DEVA’s engineering achievements combining simplicity of use, affordability of price and top performance and employing an array of technical parameters not found in any other device of its class.

Product Features

- Ultra low latency, all-digital DSP based design
- Advanced Wide Band AGC
- 4-Band Parametric EQ
- Advanced Bass & Treble Controls
- 4-Band Limiter
- FM Controlled distortion Limiter
- 4-Band Dynamic Processor with Fidelity and Sound Impact System
- HD Lookahead Limiter
- Extensive set of factory presets and several customizable user presets
- L/R Analog inputs and outputs and two independent Composite MPX outputs.
- Integrated digital stereo generator with advanced peak control
- Built-in web server for remote control access via TCP/IP connection
- Software Control (over local network or the Internet using any Windows® PC)
- Built in DSP-based RDS/RBDS encoder
- Bright, wide view angle OLED and full-time LED meters
- Easy setup and control via the front panel
- Remotely upgradable firmware to ensure improved operation
- Headphone output with front panel level control
- Intelligent Silence Detector
- Fallback function in case of Audio Loss
- Variety of Audio Sources
- Multi-format IP Audio Player
- Built-in MP3 Player
- SD Card for Audio Backup Storage
- Externally synchronized output sample rate
- Tight peak control at all outputs
- EMI-suppressed XLR connectors
- Stereo encoder integrated with audio processing
- Bypass and Test tone Mode
- Embedded SNMP agent permitting full device management
- Easy to use WEB interface
- Apple and Android devices support
- SNTP for automatic synchronization of the built-in clock
- Notifications on input/preset change via E-mail and SNMP
- Protected access to the device settings
- Professional AES/EBU Digital audio inputs
- Level Adjustable, Balanced Analog and Digital Audio Outputs
- LAN port for full TCP/IP remote control and monitoring
- USB communication interface for local connectivity
- Easy Installation and Setup
- Wide operating voltage range: 100-240V AC
- 19" Professional Case for high RF immunity

TECHNICAL SPECIFICATIONS

ANALOG AUDIO INPUT	
Connectors	Main - Two XLR, EMI suppressed, electronically balanced; Auxiliary - DB9, EMI suppressed, electronically balanced
Configuration	Stereo
Input level (0 dBFS)	Software selectable -8 dBu to +24 dBu peak
Impedance	Jumper selectable 600Ω / >10kΩ
A/D Conversion	24 bit; 48 kHz sample rate; Differential inputs
ANALOG AUDIO OUTPUT	
Connectors	Two XLR, EMI suppressed, electronically balanced
Configuration	Stereo. Software selectable flat, pre-emphasized or de-emphasized
Output Level (0 dBFS)	Software selectable -12 dBu to +24 dBu peak into $\geq 600\Omega$ load
Source Impedance	20Ω
Load Impedance	$\geq 600\Omega$, balanced/unbalanced
Signal-to-Noise	≥ 110 dB unweighted (Bypass mode, digital input, flat, 20Hz-15kHz bandwidth, referenced to +12 dBu output level)
Distortion	≤ 0.01 THDN (Bypass mode, digital input, flat, 20Hz-15kHz bandwidth, referenced to +12 dBu output level)
D/A Conversion	24 bit; 192 kHz sample rate; Differential outputs
DIGITAL AUDIO INPUT	
Connectors	Main - XLR, EMI suppressed, transformer balanced and floating; 110Ω impedance; Auxiliary - DB9, EMI suppressed, transformer balanced and floating; 110Ω impedance
Configuration	Stereo AES3 standard, up to 24 bit resolution
Sampling Rate	22 kHz to 192 kHz
Input Gain	-20 dB to 20 dB, referenced to 0 dBFS, software selectable
DIGITAL AUDIO OUTPUT	
Connector	XLR, EMI suppressed, transformer balanced and floating; 110Ω impedance
Configuration	Stereo AES3 standard, 24 bit resolution. Software selectable flat, pre-emphasized or de-emphasized
Sample Rate	Internal - 32, 44.1, 48, 88.2, 96, 176.4, 192 kHz. Externally synced to Main AES3 digital input at 32 to 192 kHz. Software selectable.
Word Length	24 bit
Output Reference Level	-20 to 0 dBFS software selectable

COMPOSITE BASEBAND OUTPUT	
Connectors	BNC unbalanced, chassis floating, EMI suppressed
Configuration	Two outputs. Independent level control. MPX+MPX, MPX+PILOT or BYPASS mode
Source impedance	75Ω
Load impedance	50Ω or greater
Output level	-18dBu to +18dBu
Pilot level	0% to 15%
D/A conversion	24 bit, differential
SNR	>80 dB (Bypass mode, flat, 20Hz - 15kHz bandwidth, Digital input referenced to -10dBFS, unweighted)
THD	< 0.01% (Bypass mode, flat, 20Hz - 15kHz bandwidth, Digital input referenced to -10dBFS, unweighted)
Stereo Separation	>60dB
Crosstalk	>70dB
Pilot protection	>90dB relative to 9% pilot injection, ±250 Hz
38 kHz suppression	>80dB (referenced to 100% modulation)
REMOTE ACCESS INTERFACE	
Configuration	TCP/IP via USB or Ethernet interface
USB Connector	USB type B connector
Ethernet Connector	Female RJ45 shielded connector for 10/100 Mbps CAT5 ethernet networks
REMOTE CONTROL INTERFACE (GPI)	
Connector	DB-9 male
Configuration	Eight LED optocoupler, current limited cathode inputs. Anodes are connected to VCC internally.
Control	Selects corresponding user preset if connected to GND
OPERATING CONDITIONS	
Temperature	-15°C to 55°C
Humidity	< 95%, non-condensing
Altitude	0 to 5000m above sea level
POWER	
Voltage	100-240 VAC, 50-60 Hz, 30VA
Connector	IEC, Fused and EMI-suppressed. Detachable 3-wire power cord supplied
SIZE AND WEIGHT	
Dimensions (W;H;D)	483 x 44 x 180 mm / 19 x 1.875 x 7"
Shipping Weight	540 x 115 x 300 mm / 2.6kg

Front Panel

OLED DISPLAY



DB6400 has easy to read, high-resolution OLED graphical display that visualizes all measurements of the received signal and DB6400's settings.

LED METERS



The full-time LED meters allow quick and easy monitoring of the metering, making the setup, adjustment and programming easy.

CONTEXT-SENSITIVE SOFT BUTTONS

Used for navigation through the menus, quick access to the parameters, modes, functions and to alter their values. The Soft Buttons indicators are placed on the bottom side of the OLED display. Depending on the currently selected menu context the indicators change their function. The Soft Buttons will be referred as (left-to-right) [SB1], [SB2], [SB3] and [SB4].

NAVIGATIONAL BUTTONS

[UP], [DOWN], [LEFT], [RIGHT] and [OK] buttons, as the Soft Buttons, are used to navigate through the menus selecting various functions and parameters of DB6400.

REAR PANEL

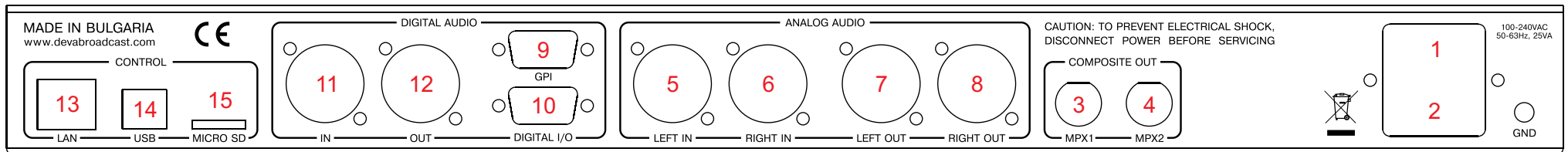

1. Mains connector, 100-240 VAC, 50-60 Hz, 30VA, IEC-320 C14 type, EMI-suppressed;
2. Fuse holder;
3. MPX Output 1 – BNC;
4. MPX Output 2 – BNC;
5. Analog Audio Left Input – XLR;
6. Analog Audio Right Input – XLR;
7. Analog Audio Left Output – XLR;
8. Analog Audio Right Output – XLR;
9. GPI
10. DIGITAL I/O
11. Digital Audio Input – XLR;
12. Digital Audio Output – XLR;
13. Ethernet T-BASE10/100 – RJ45;
14. USB – type B;
15. MICRO SD

REAR PANEL ALARM TERMINAL

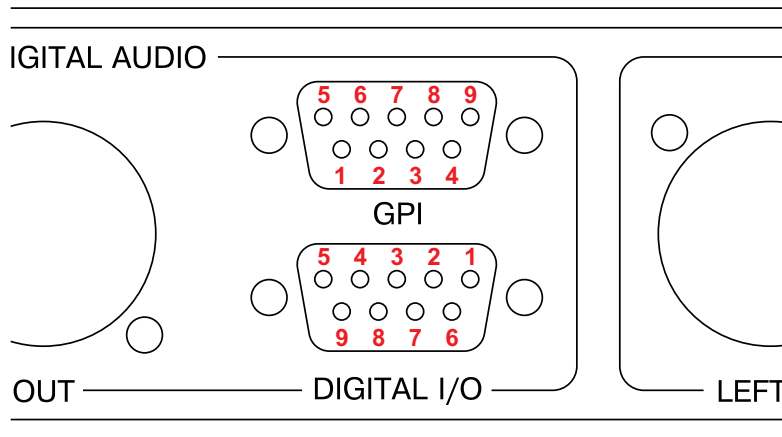

GPI Trigger Input Pins

Trigger Input Pin	User Preset Function
1	User Preset 1
2	User Preset 2
3	User Preset 3
4	User Preset 4
5	User Preset 5
6	User Preset 6
7	User Preset 7
8	RDS TA

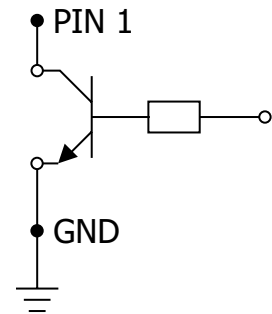
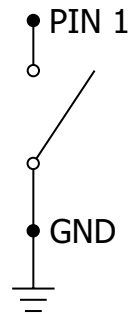

NOTE: Pin 9 is connected to GND.

Digital I/O Pins

Pin	Signal
1	Right Aux In - positive
2	Right Aux In - negative
3	Right Aux In - GND
7	Left Aux In - positive
8	Left Aux In - negative
6	Left Aux In - GND
4	Digital Aux In - positive
5	Digital Aux In - negative
9	Digital Aux In - GND

Safety Warning

ALWAYS OBSERVE THE SAFETY PRECAUTIONS.

Careful observance of the safety precautions will help prevent physical injury, damage of the equipment, and extend the equipment life.

- The servicing of electronic equipment should be performed only by qualified personnel;
- Before removing the covers the unit must be switched off and the mains cable unplugged;
- When the equipment is open, the power supply capacitors should be discharged using a suitable resistor;
- Never touch the wires or the electrical circuits;
- Use insulated tools only;
- Never touch the metal semiconductor. They might carry high voltages;
- For removing and installing electronic components, follow the recommendations for handling MOS components.
- Do not remove the factory sticker from the equipment. It contains information as regards the name, serial number and MAC address of the device.
- To join the equipment to the mains supply, use the power cord purchased with the equipment.

ATTENTION: The device has an internal Lithium battery. Do not try to re-charge this battery! In case the battery needs to be changed, please contact us for detailed instructions and information of the battery type.

Operating Recommendations

To ensure normal operation of the DEVA unit, we recommend following the instructions listed below.

- Install the unit in places with good air conditioning. The unit is designed to operate within the ambient temperature range of 10 to 50°C. The equipment rack should be ventilated in order for the device to keep its internal temperature below the maximum ambient temperatures;
- We do not recommend installation in rooms with high humidity, dusty places or other aggressive conditions;
- Although the device is intended to be installed closed to exciters or transmitters, we do recommend the device to be located away from abnormally high RF fields.
- Use only checked power supply cables. We strongly recommend the usage of shielded cables;
- Connect the DEVA unit to reliable power supply sources only. In case of unstable power supply, please use Uninterruptible Power Supply (UPS);
- Use the device only with its top cover on to avoid electromagnetic anomalies. Otherwise, this may cause problems with the normal functionality of the unit;
- To ensure normal remote operation of the unit, make sure to connect the device to a good quality Internet connection;
- For the normal operation of your DEVA device, check if the network settings past through all the required data traffic.

Unpacking and inspection

Upon receipt, the equipment should be inspected for possible shipping damages. If such are found or suspected, notify the carrier at once and contact DEVA Broadcast Ltd. The original shipping carton box and packing materials should be kept for possible reuse, in case of return for Warranty repair, for example. Shipping damages as a result of improper packing for return may invalidate the Warranty!

The packing material (plastic bags, polystyrene, nails, etc.) must never be left within reach of children, as these items are potential sources of danger.

IT IS VERY IMPORTANT that the [“Product Registration Card”](#) included in the Manual be completed accurately and returned. This will assure coverage of the terms of the Warranty and it will provide a means of trace in case of lost or stolen equipment. In addition, the user will automatically receive SERVICE OR MODIFICATION INSTRUCTIONS from DEVA Broadcast Ltd.

Mounting

RACK REQUIREMENTS 1U

The unit mounts in a standard 19-inch equipment rack and requires only 1 $\frac{3}{4}$ inches (1U) of vertical rack space. In order the painted finish around the mounting holes to be protected, the use of plastic washers is recommended.

RACK REQUIREMENTS COMPACT UNITS

Our customized 1U 19-inch rack accessory provides a professional mounting option for up to three compact size DEVA units. It is made of milled aluminum and finished in black powder coat. Two extra blanking panels and set of mounting screws are provided with each rack bracket kit.

STAND-ALONE DEVICES

DEVA's stand-alone units (Radio Explorer series, BandScanner series, DVB Explorer) do not require additional tools or installation brackets.

AC Mains Power

FUSE HOLDER

The fuse holder is placed inside the unit, next to the voltage selector. Apply downward pressure and pull the cap outward to access the 5mm mains fuse. The reverse process will release the cap.

MAINS VOLTAGE SELECTOR

Before connecting the AC Power, make sure that the internal Power Switch is in accordance with the mains supply at your location. The Power Supply Factory Settings are:

- 100 - 240 VAC
- 1 Amp Fuse

CAUTION: Permanent damage will result if improper AC supply voltage is applied to the device. The warranty DOES NOT cover damages caused by applying improper supply voltage or usage of improper fuse.

POWER CORD

The detachable IEC-type power cord is supplied with the unit. The individual cord conductors may be color-coded in either of two ways:

- 1) In accordance with US standards:
BLACK = AC "HOT"
WHITE = AC NEUTRAL
GREEN = EARTH GROUND

- 2) To European CEE standards:
BROWN = AC "HOT"
BLUE = AC NEUTRAL
GREEN/YELLOW = EARTH GROUND

GROUND LOOPS

Because the unbalanced INPUTS/OUTPUTS of the device are chassis-ground-referenced, a mains frequency or INPUT/OUTPUT ground loop could be formed between the input or output cable shield grounds and the AC power cord ground. A 'ground-lifting' AC adapter may help in this situation, although the chassis must be properly grounded for safety purposes. In general, the equipment being installed in a rack will satisfy the safety requirement.

DB6400 Location

The best location for DB6400 is as near as possible to the transmitter, so that its stereo encoder output can be linked to the transmitter through a circuit path. It is mandatory that the cable used for connection between DB6400's MPX output, and the MPX input of the transmitter be as short as possible. This will prevent any phase distortion. If this configuration is not possible, the DB6400's AES3 digital audio output can be fed through an all-digital, uncompressed path to the transmitter exciter.

The usage of left and right analog audio outputs is recommended in the situations when the stereo encoder and exciter are under the jurisdiction of an independent transmission authority, and the programming agency's jurisdiction ends at the interface between the audio facility and the link connecting the audio facility to the transmitter. (The link might be telephone / post lines, analog microwave radio, or various types of digital paths.)

Source Material Quality

The DB6400 is designed to achieve perfect sound quality, regardless of the source material. Though, it is very important that the source audio to be as clean as possible, as upon processing the poor-quality source material will cause distortion and unpleasant audio defects.

Getting Started

In order for the normal operation of the DB6400 to be guaranteed, you will need fulfill the following conditions:

1. Standard Ethernet 10/100M connection;
2. Correctly assigned Network configuration and device settings.

To make sure that all the conditions are fulfilled please, follow the instructions below.

CONNECTION

1. Install the unit on its operation place;
2. Using the provided power cable, connect the unit to the power supply network;
3. Connect the antenna cable to the RF antenna input connector located on the rear panel of the device;
4. Connect the DB6400 to the TCP/IP network using direct network cable;
5. **IF GSM OPTION IS SUPPORTED** - Using the connection cable provided, connect the optional GSM modem. In order for better GSM network coverage to be achieved, please select proper place for the GSM antenna.

NOTE: The GSM antenna must be installed far enough from the monitoring devices. The GSM modem radiates RF signal that may cause spurious emissions that will may interfere with the accuracy of the measurements.

NETWORK SETTINGS

After connecting the network cable the Led 'LAN' located on the rear panel must be ON or flashing. The next and most important step for configuration is the adjustment procedure of the Network Communication. The settings shown below are Default Network Settings:

DHCP	Enabled
IP	Assigned by DHCP
Mask	Assigned by DHCP
Gateway	Assigned by DHCP
DNS	Assigned by DHCP
HTTP Port	80

NETWORK DISCOVERY

This is a network setting that defines whether your computer can see (find) other computers and devices on the network and whether other computers on the network can see your computer. By default, Windows Firewall blocks network discovery but you can enable it.

1. Open Advanced sharing settings by clicking the Start button, and then on "Control Panel". In the search box, type "network", click "Network and Sharing Center", and then, in the left pane click "Change advanced sharing settings";
2. Select your current network profile;
3. Click "Turn on network discovery", and then click save changes.

NOTE: If you're prompted for an administrator password or confirmation, type the password, provide confirmation or contact your system administrator.

If you have already enabled this function on your computer DB6400 will be automatically added to the Device list section. The device will be ready for usage and no additional adjustments will be required except user name and password.

NOTE: If the port is different than the default one (80), it is necessary to specify it, for example:
`http://192.168.1.2:9000`

ATTENTION: Depending on Internet Protocol Settings, the assigned IP address may not be visible outside your local network, thus the device may be accessed only within that network. Consult with your network administrator for the appropriate IP settings.

NETWORK SECURITY RECOMMENDATIONS

1. It is not recommended the DB6400 to be directly connected to the Internet. This may lead to unregulated access and/or problematic operation of the device. To ensure secure connection, we recommend the device to be installed behind a router with an active firewall.
2. If remote access to the device is needed, we recommend using VPN to the router or the port of the relevant service (WEB, SNMP, Application, etc.) to be properly NAT forwarded.
3. If NAT forward is used, it is highly recommended random ports of your choice to be used. Not the standard ones (80 for WEB, 161 for SNMP, etc.).
4. Using DMZ connection is not recommended.
5. Make sure to change the standard access credentials (usernames and passwords, SNMP communities).

For detailed information as regards the recommendations listed above or need of further instructions, please contact your network administrator.

Operation

PROCESSING PATH

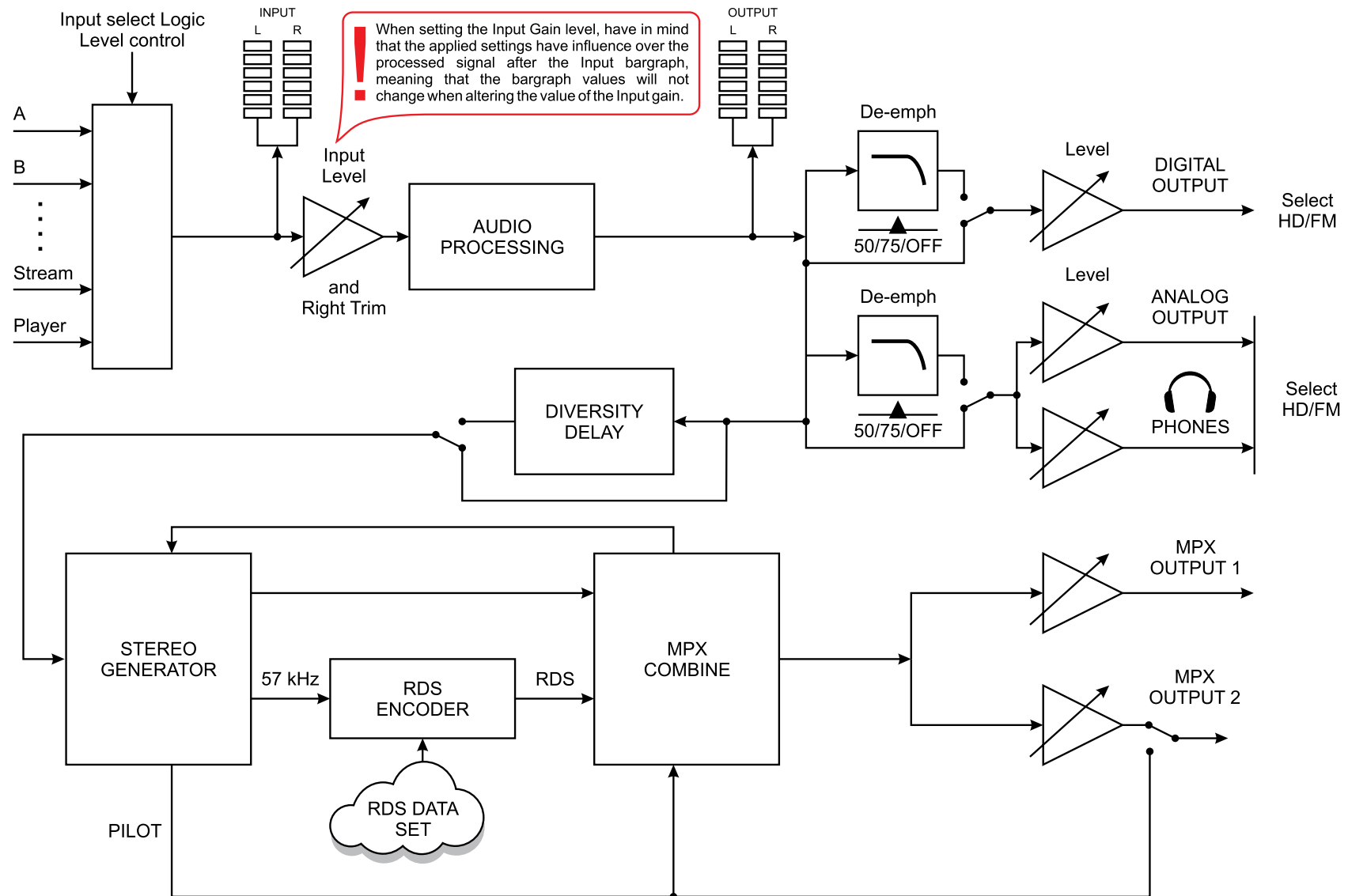

AUDIO PROCESSING EXPLAINED

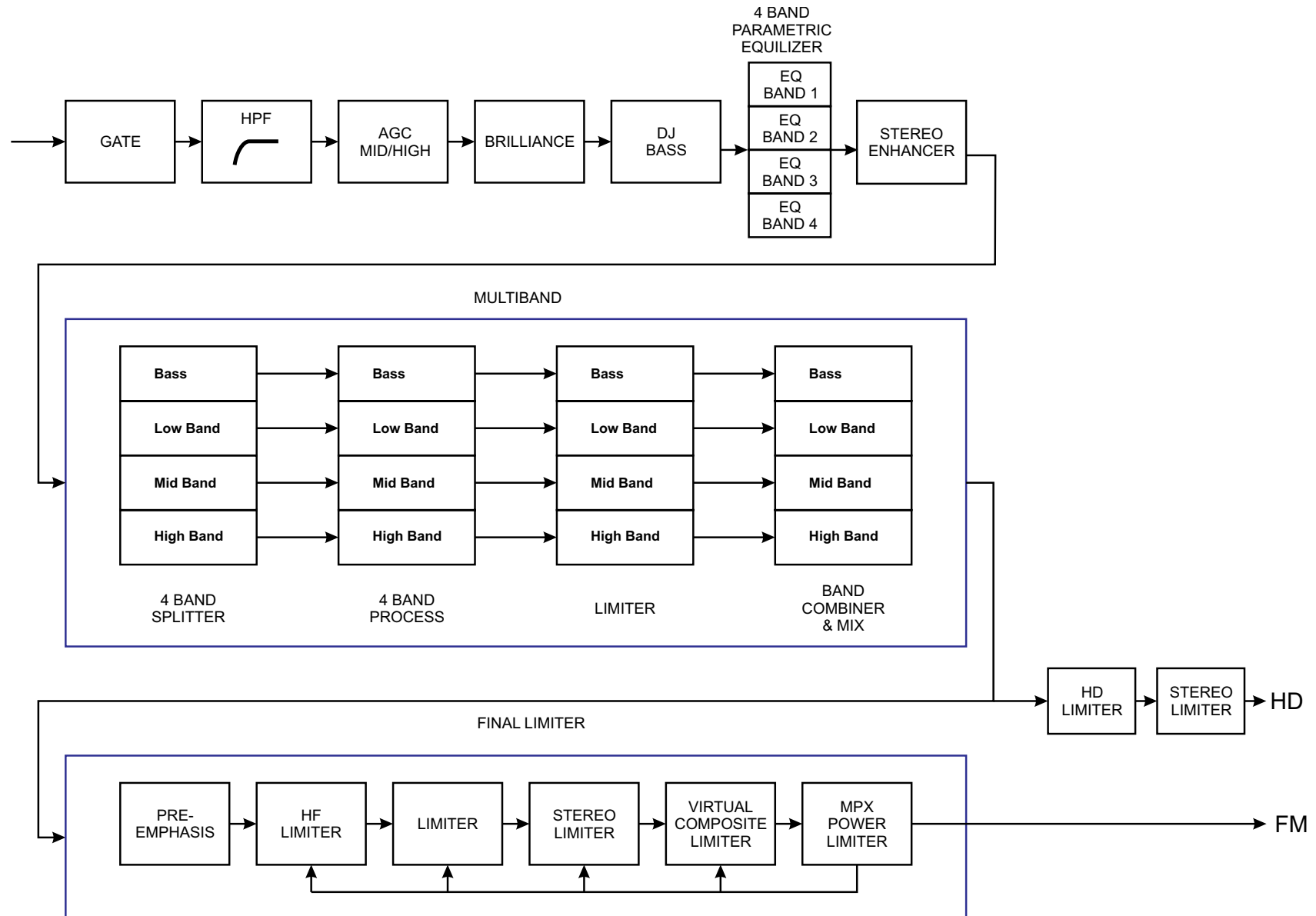

Basic Setup/Connection Example

REFERENCING ANALOG AND DIGITAL INPUTS LEVEL

In order for the proper work of DB6400 to be guaranteed, and due to the variability of the signal levels, the right reference levels of the digital and analog inputs should be set.

The process of aligning the signal levels to the needed boundaries is called referencing inputs. The Reference level is specified depending on the intended source device and typical program material fed at the input.

The Reference level (Ref. level) represents the amplitude of the input signal applied at DB6400's analog input, which after ADC (analog-to-digital converter) will be considered as 0dBFS. The set Ref. Level value must be conformable to all operating conditions, as the level of the analog program material at the input should not be higher than that. Setting Reference level that is unnecessarily high may affect the dynamic range of the input and to increase the noise level.

Depending on the dynamics of the audio program, fed at the input, we recommend the Ref. Level set to have headroom from 4dBu to 12dBu above the audio program. For example:

Audio program level at the input: 6dBu
Headroom: 10dBu
Ref. Level to be set: 16dBu = 6dBu + 10dBu

In case of sudden amplitude transients or unanticipated loud events in the program, the material reserve guarantees that the signal will not be clipped.

For the analog inputs the reference level is set in the *Input>Analog Inputs Reference Levels>Main Level* and *Input>Analog Inputs Reference Levels>Aux Level*. With default values as follows:

- Main Level - 12.0 dBu;
- Aux Level - 12.0 dBu.

The reference level that could be set is between **-8dBu** to **+24dBu**.

As a general rule, when the Ref. level is properly selected, DB6400's front panel AGC indicator should vary from 6/9 during continuous operation.

If AGC indicator is constantly at its lowest value, the set Ref. Level should be increased. If the maximum possible value of **24dBu** is met, the level of the audio program fed at DB6400's analog input should be reduced.

If the AGC indicator is constantly at its highest value- the Ref. Level should be reduced. If the minimum value of **-8dBu** is met, the level of the audio program at the input increased.

DB6400 digital inputs have pre-defined reference level of 0dBFS, but in order for the signal to be reduced or increased to values guaranteeing the best performance of the audio processor, user defined values of the main and auxiliary digital inputs could be set. The preferred levels are set in the *Input>Digital Inputs Reference Levels>Main Level* and *Input>Digital Inputs Reference Levels>Aux Level*. With default values as follows:

- Main Level - 0.0 dBFs;
- Aux Level - 0.0 dBFs.

Please have in mind that when applying these settings, if need be, the signal received from the corresponding digital input can be amplified. The excessive increase, however, can lead to unwanted signal clipping.

IT IS VERY IMPORTANT the signal fed at the any input of DB6400 not to exceed the specified reference level, otherwise it will cause clipping, distortion and unpleasant audio defects.

REFERENCING ANALOG AND DIGITAL OUTPUTS LEVEL

These settings define the value of 0 dBFS when converted to dBu. Similarly to the input Ref. Level, the output Ref. Level determines the amplitude of the respective output, which corresponds to 0dBFS. The value is set depending on the level requirements of the device connected to DB6400's digital output. Having the proper Ref. level set at the output of the audio processor, guarantees that the signal amplitude at the input of the subsequently connected device will be within the required optimal range. As a general rule, the amplitude of any of DB6400's outputs cannot exceed the Ref. Level set for this output.

For the analog output, the Ref. Level could be set in the range of **-12dBu** to **+24dBu** with **0.5dB** step. For the MPX outputs, the Ref. Level is set in the range of **-18dBu** to **+18dBu** with **0.1dB** step.

For the digital output, the Ref. Level is set in the range of **-20dBFS** to **0dBFS** with **0.5dB** step. The preferred output values could be applied via the front panel, menu paths::

Output> Analog Out Level;

Output> Digital Out Level;

Output> MPX 1 Out Level;

Output> MPX 2 Out Level.

SETUP WITH ANALOG PROGRAM INPUTS

DB6400 is fed with analog audio. The main program output is sent to the DB6400 Audio Processor via XLR Connection. The MPX composite output is sent via BNC connection to the transmitter's MPX input. The audio processor output used is MPX OUT -1.

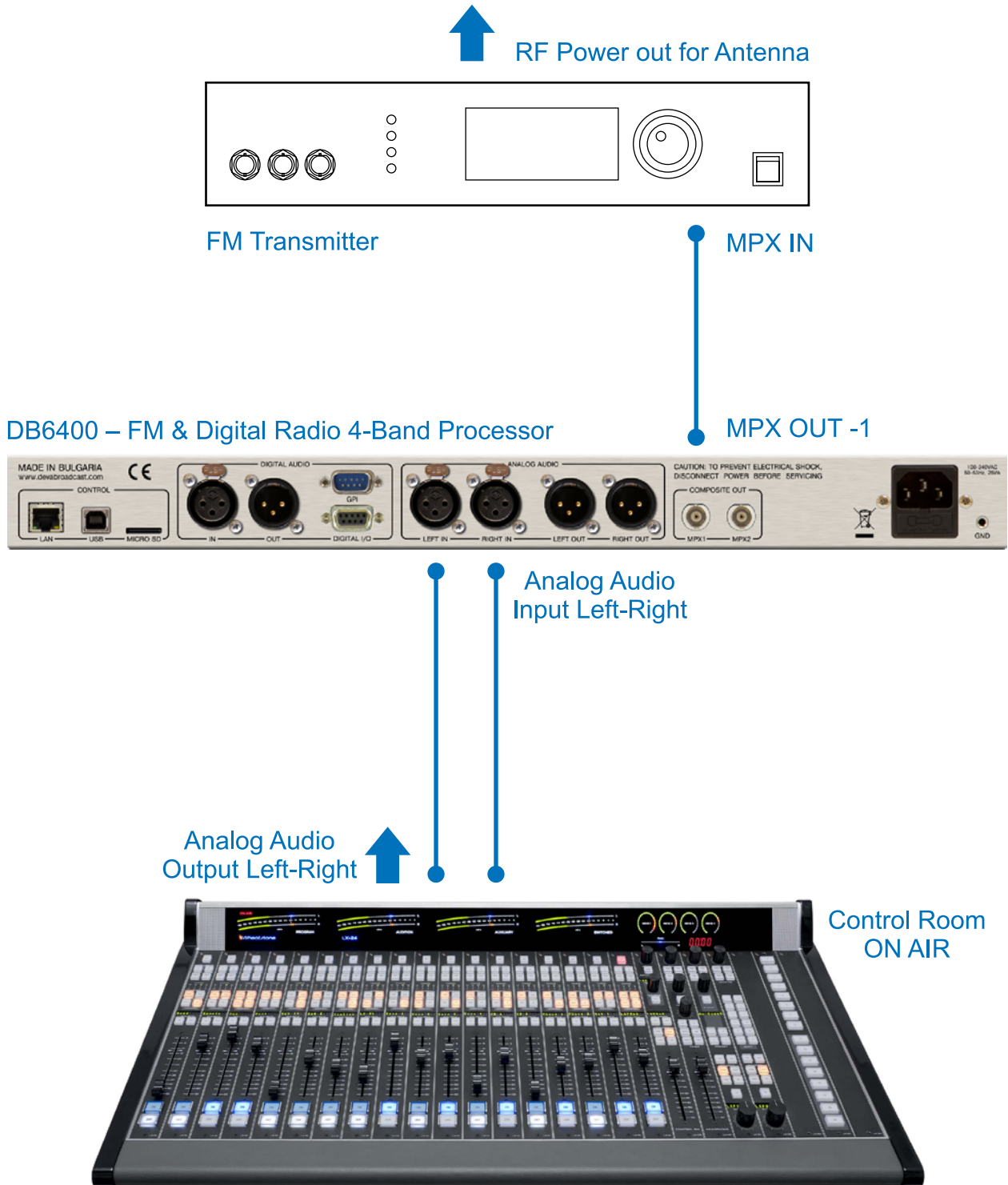

BROADCAST CONSOLE

IMPORTANT RECOMMENDATION: It is mandatory that the cable used for connection between DB6400's MPX output, and the MPX input of the transmitter be as short as possible. This will prevent any face distortion.

SETUP WITH DIGITAL PROGRAM INPUTS

DB6400 is fed with AES/EBU digital audio. The main program output is sent to the DB6400 Audio Processor via XLR Connection. The MPX composite output is sent via BNC connection to the transmitter's MPX input. The audio processor output used is MPX OUT -1.

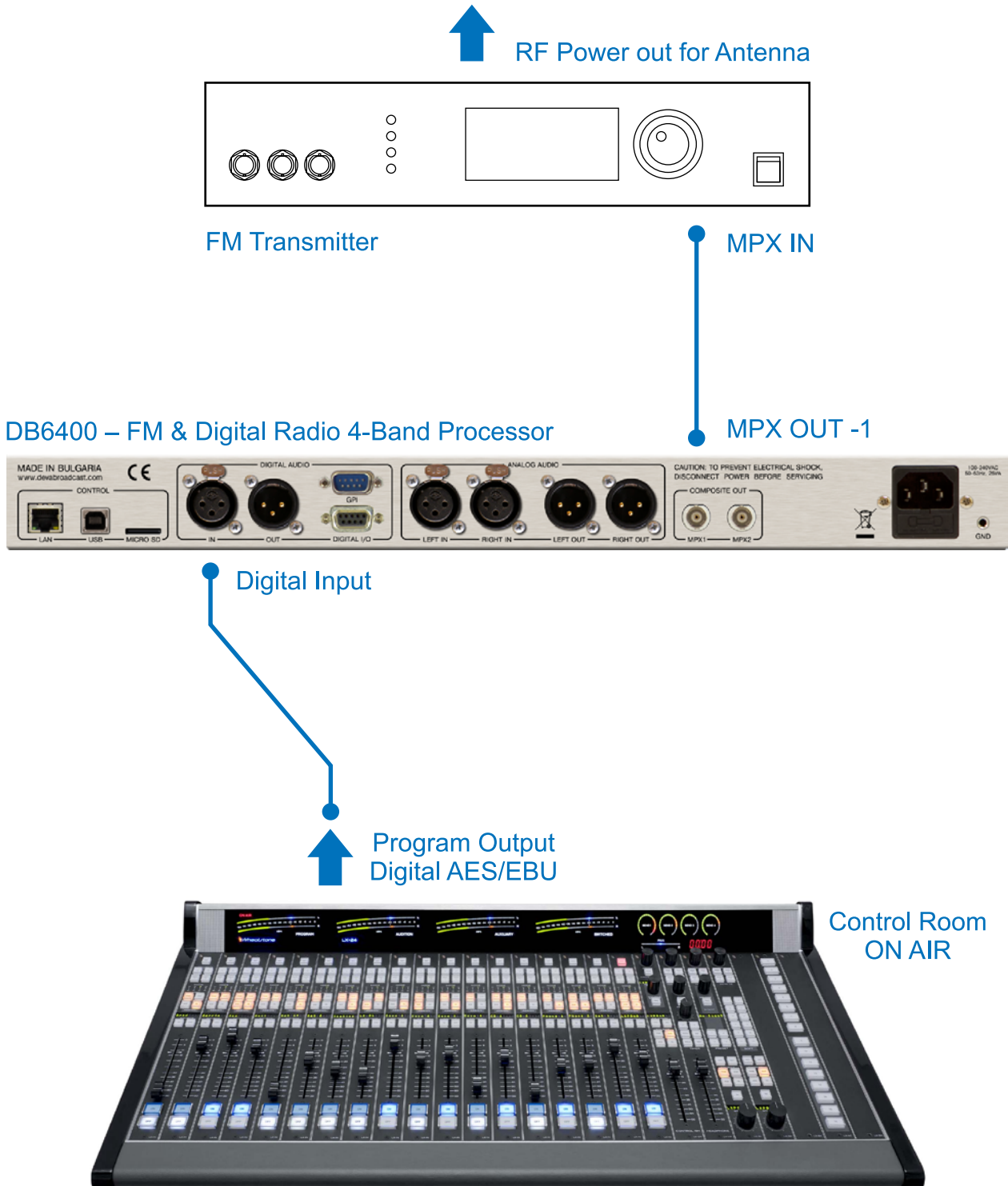

BROADCAST CONSOLE
DIGITAL

IMPORTANT RECOMMENDATION: It is mandatory that the cable used for connection between DB6400's MPX output, and the MPX input of the transmitter be as short as possible. This will prevent any face distortion.

ANALOG CONNECTION WITH TWO TRANSMITTERS

Possible configurations:

- Program transmitter and second standby transmitter;
- Two program transmitters broadcasting on different frequencies via analog audio connection.

The main program output is sent to the DB6400 via XLR connector. The MPX composite output is sent via BNC connection to the transmitter's MPX input. The audio processor's outputs used are MPX OUTPUT – 1 (for the main program) and MPX OUTPUT – 2 (for the standby/second frequency).

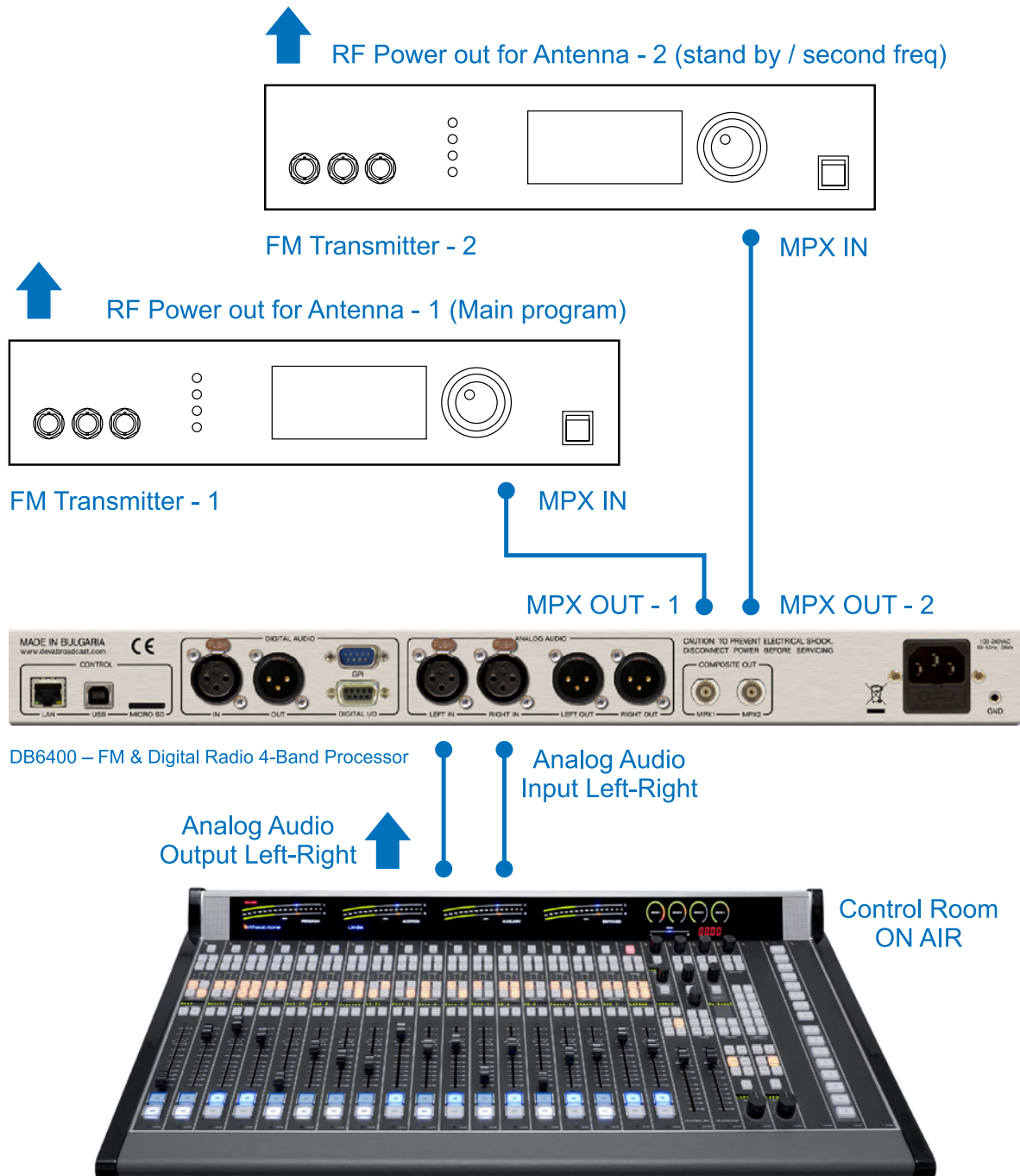

IMPORTANT RECOMMENDATION: It is mandatory that the cable used for connection between DB6400's MPX output, and the MPX input of the transmitter be as short as possible. This will prevent any face distortion.

ANALOG CONNECTION WITH DEVA SMARTGEN 6.0

The DB6400 has built in basic RDS/RBDS Encoder, in case additional RDS/RBDS Encoder is added, a “Loop Through” and “Side-chain” connection with the audio processor can be made.

Side-chain

Side-chain – the RDS& MPX output is sent to the Input SCA input, while to provide the RDS encoder with a Sync signal for the 19 kHz pilot tone, the entire program can be taken out via MPX OUT-2. Make sure that you will not send the same signal as the one generated by the RDS encoder to the MPX OUT-2.

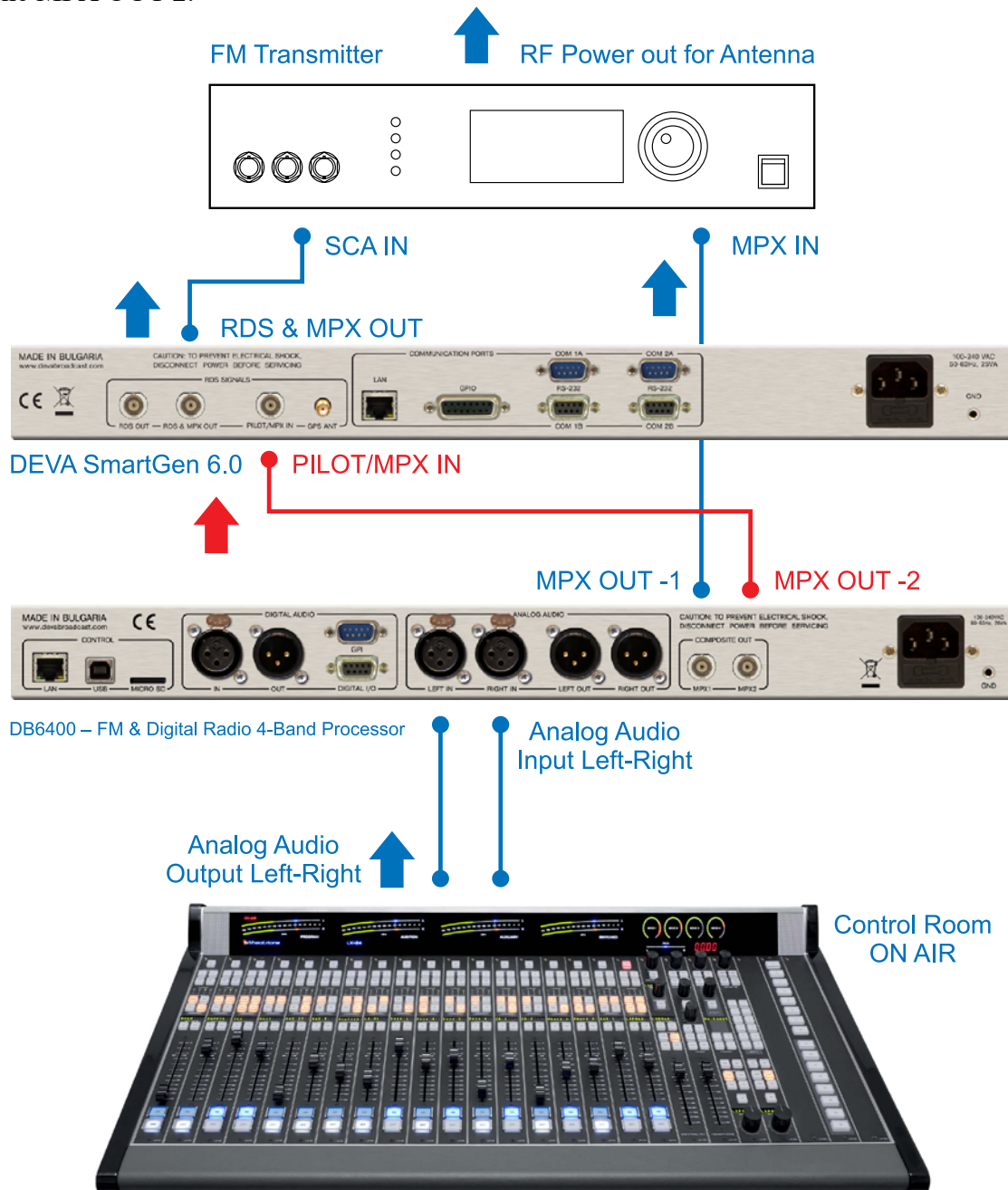

BROADCAST CONSOLE

IMPORTANT RECOMMENDATION: It is mandatory that the cable used for connection between DB6400’s MPX output, and the MPX input of the transmitter be as short as possible. This will prevent any face distortion.

Loop through

The output of the DB6400 is wired directly to the PILOT/MPX IN of the SmartGen 6.0. The output of the RDS encoder will be connected to the composite/MPX input of the FM transmitter. This connection is not recommended, because the composite signal/MPX passes through the RDS encoder, and the transmission of the program will be interrupted in case of failure of the RDS encoder. If you are using SmartGen 6.0, such failure will be prevented, as the DEVA technology includes a Hardware Bypass between RDS & MPX OUT and MPX Input of the FM Transmitter. The RDS Subcarrier phase will be locked to the MPX stereo FM Signal on the outside.

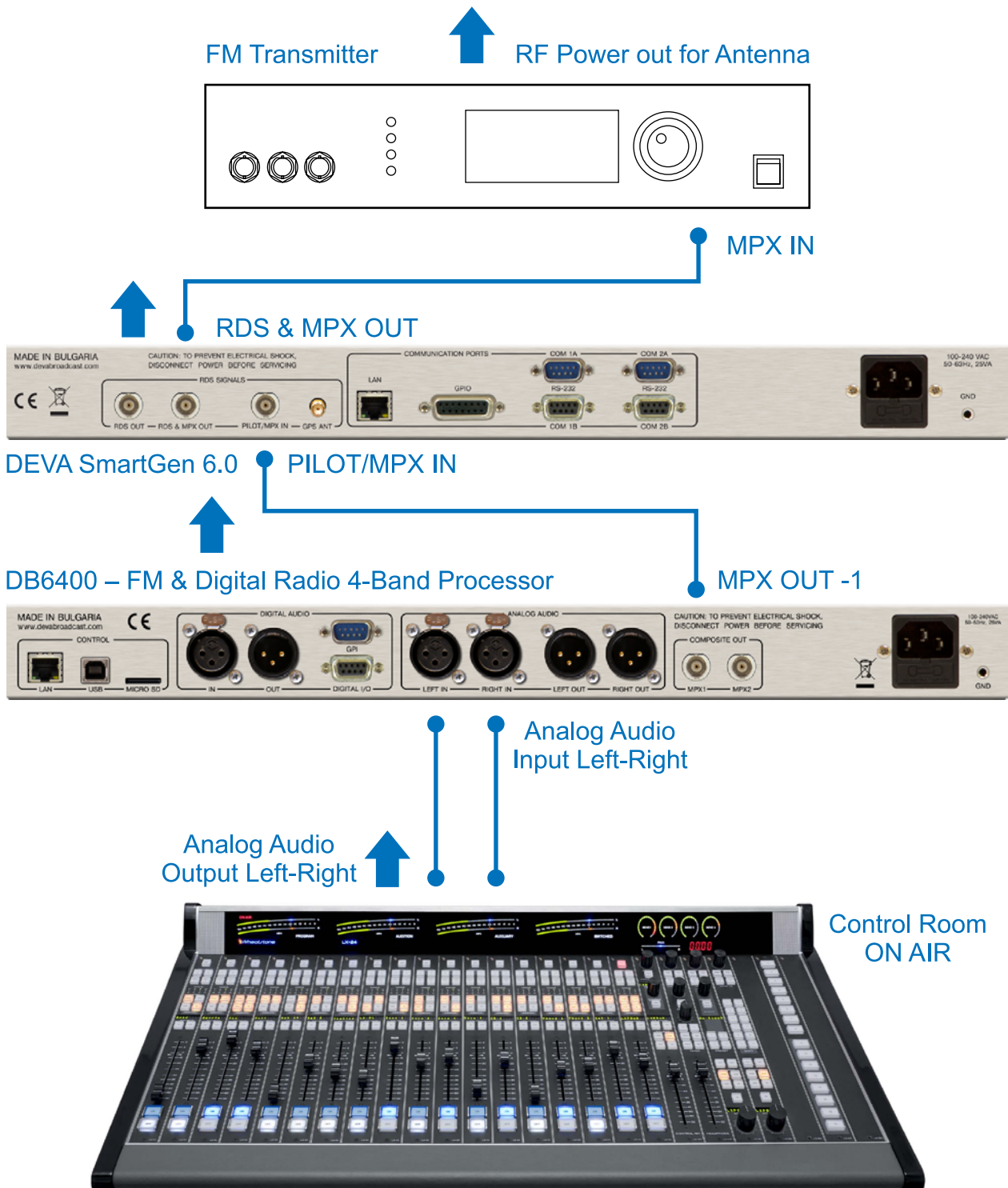

BROADCAST CONSOLE

OLED Display, Navigational & Soft Buttons

OLED DISPLAY

DB6400 has an easy to read, high-resolution OLED graphical display that visualizes all measurements of the received signal and settings. Upon switching it on, the Company Logo and model of the device will be displayed. After a few seconds the Start-up screen will disappear, replaced by the Main Screen. This is the starting point of the navigation process.

DB6400's OLED display has three function areas: Header, Soft Buttons and Main Screen Working area.

Header area

The Header is located on the left part of the screen. The header content is determined according to the work area context and may include the following functions:

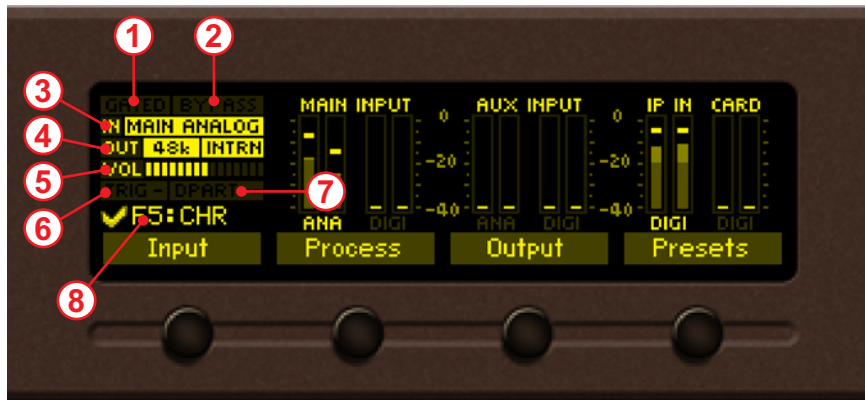

- GATED FLAG (1) – Will appear if the signal at the input is below the specified in **Process> Input Threshold level**.
- BYPASS FLAG (2) – Will appear if the entire processing is bypassed.
- IN (3) – Represents the currently selected active Input. If due to some reason the backup is activated the input information will start blinking, thus indicating that there is a problem with the main source.
- OUT (4) – Represents the currently selected active Output and its value. There are two types of digital output synchronization – internal and external. When the synchronization is internal the values will appear as depicted. If the output is set to external synchronization, this will be indicated with the following text - SYNC LOCK. If and due to some reason the external sync source has been loss, the indication will change to SYNC UNLOCK and start blinking. Then, the DB6400 will switch to the internal sync source. For further information, please refer to [“Output” on page 75](#).
- VOL (5) – Indicator showing the phones audio volume;
- TRIG FLAG (6) – Will appear if a preset has been triggered electrically via outside equipment. The number of the GPI will also be displayed and below will be the currently used user preset.
- DAYPART FLAG (7) – Will appear when the option is in use.
- Currently selected preset (8)

Main Screen working area

The Main part of the OLED Screen is where the data changes dynamically, depending on the selected operating mode. The Menu Screen (shown below) appears upon pressing of the [OK] Navigational Button. DB6400's *Menu Page* contains selectable icons and soft buttons for selecting modes and functions. Pressing [LEFT] and [RIGHT] arrow buttons will change the icon selection on the Menu Page. The current selection is shown as a rectangle focus frame around the icon. Pressing [OK] button will navigate to the corresponding page.



Soft Buttons

Used for navigation through the menus, quick access to the parameters, modes, functions and to alter their values. The Soft Buttons indicators are placed on the bottom side of the OLED display. Depending on the currently selected menu context, the indicators change their function. The Soft Buttons will be referred to as (left-to-right) [SB1], [SB2], [SB3] and [SB4].

The purpose of all Soft Button corresponds to the selected menu page. Most pages have the same or similar functional areas. The corresponding functions as Function, Menu Page, Parameter to be changed, etc., linked with the Soft buttons will appear as labels above them.

For example:

[SB1] – *Input*

[SB2] – *Process*

[SB3] – *Output*

[SB4] – *Presets*

NOTE: On some pages, the Header and Soft button area will disappear in order to expose the content underneath.

Navigation Buttons

[UP], [DOWN], [LEFT], [RIGHT] and [OK] buttons are used to navigate through the menus, for selecting various functions and parameters of DB6400. The Main Menu structure has an up-and-down basis, expanded with left-to-right branches.

Menu Pages

The front panel menu is divided into several subsections, each of them containing parameters important for the processing and monitoring purposes. The most important settings are assigned to the soft buttons and automatically displayed on the OLED screen upon start-up of DB6400.

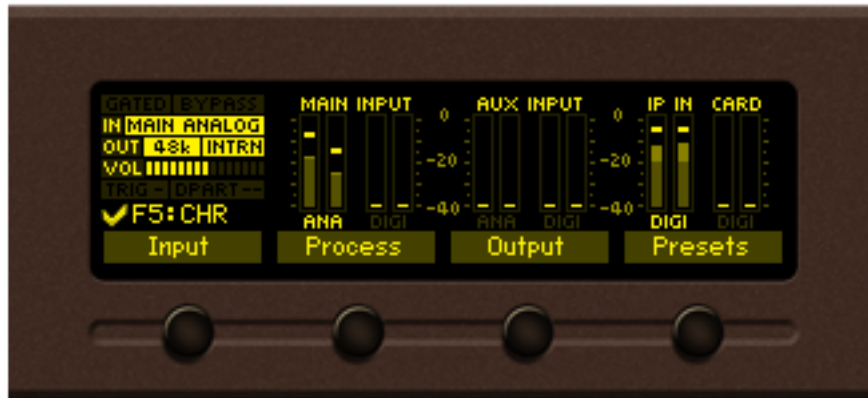

[Input]

All important settings to the analog inputs of DB6400, the Fallback sources etc., can be applied through this menu. In order for the proper work of DB6400 to be guaranteed, the right reference levels of the digital and analog inputs should be set. For further information, please refer to [“Input” on page 58](#).

[Process]

All the audio processing path parameters that can be altered as per the user’s requirements are found here – *Name, Input, AGC/Stereo FX, Tone FX, Band, Final Limiter, MPX*.

[Output]

Just as the *Input* menu, all the needed settings to the output levels are applied through here, allowing quick and easy set-up.

[Presets]

The DB6400 has an extensive set of factory presets and provision of 20 user ones. In order for a preset to be used, navigate to the desired preset and press the soft button labeled [Load], then [OK] and the preset will be loaded. For further information on the available presets and how to create a new one, please refer to [“Presets” on page 55](#).

Quick access to the most important status and audio parameters is also available via the [UP] and [DOWN] Arrows keys. Pressing the [UP] key will visualize the following screens:

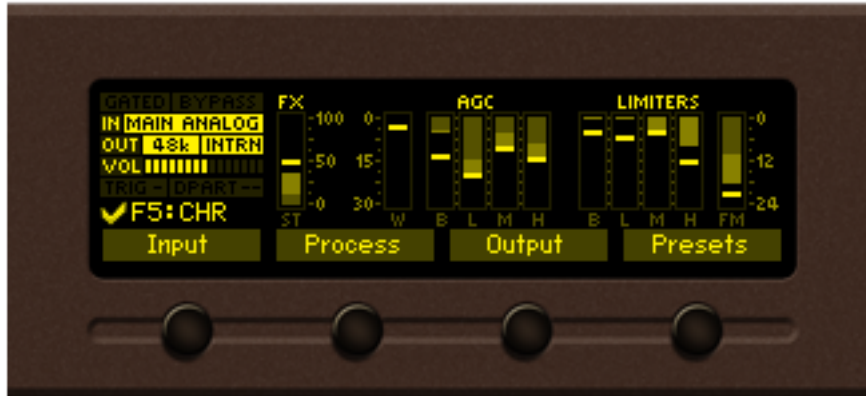

Processing parameters, represented as bar graphs.



Left and Right Audio Input Levels (dBFS), represented as bar graphs.



Left Input level (dBFS), represented as graph.



Right Input level (dBFS), represented as graph.

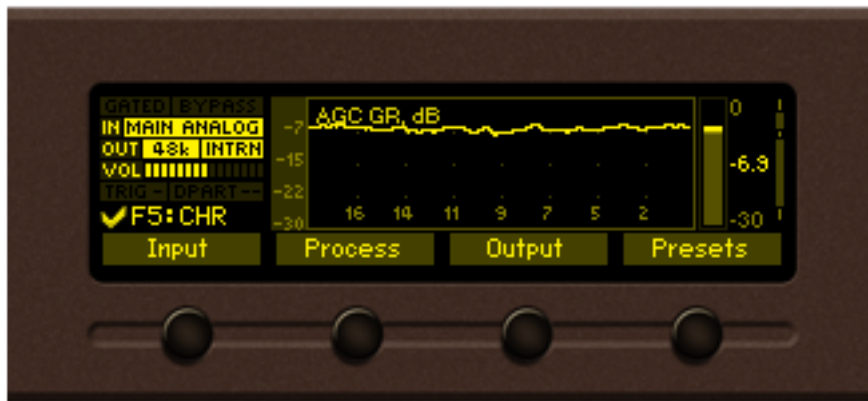

AGC GR (dB), represented as graph.



Stereo Width(%), represented as graph.



Output Left level(dBFS), represented as graph.



Output Right level(dBFS), represented as graph.



MPX Deviation (%), represented as graph.



MPX Power (dBr), represented as graph.

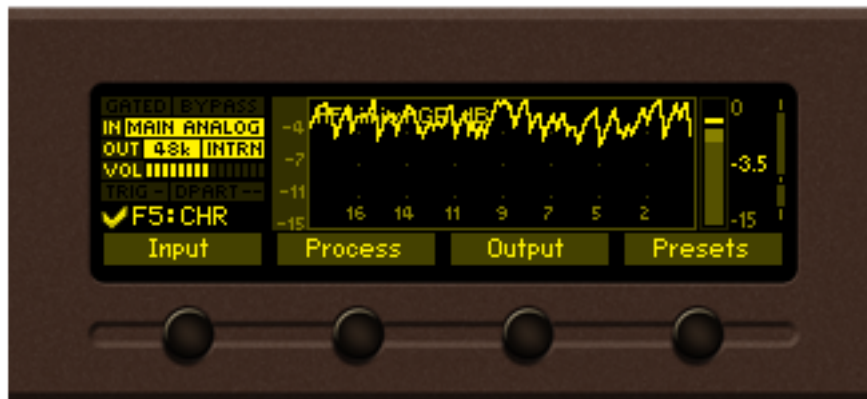

HF Limiter GR (dB), represented as graph.



ST Limiter GR (%), represented as graph.

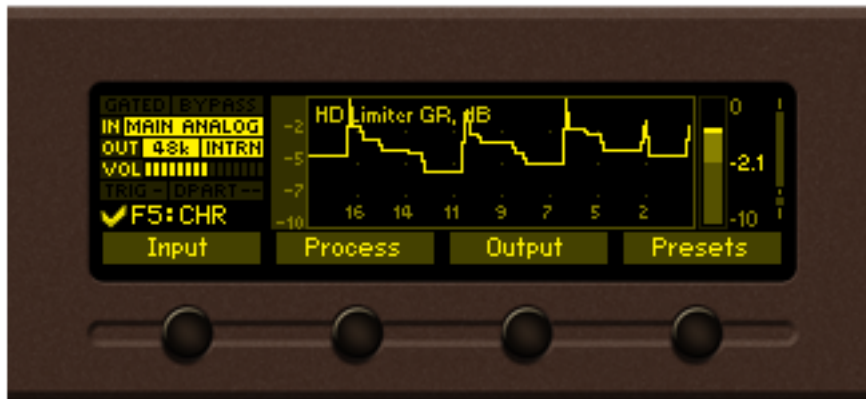

HD Limiter GB (dB), represented as graph.

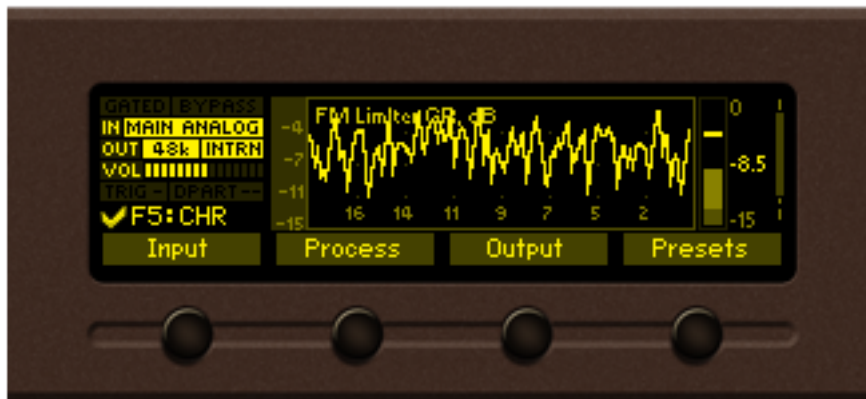

FM Limiter GR (dB), represented as graph.



RDS Screen

Settings

All the needed settings to the DB6400 as regards the *Security*, *Dayparting*, *Communication*, *Trigger ports* and *Device* are applied through this menu.

From the same section the *username* and *password* for the WEB interface access can also be changed.

TRIGGER PORTS



If enabled the remote trigger port will allow you to select any of the first 7 user presets by pulling one of the 7 pins on the trigger port socket. If more than one pin is triggered at the same time, the pin with the lowest number will be with highest priority. For example, if all pins are pulled low, trigger 1 will be with highest priority.

Trigger port	User Preset Number
Trigger Input Pin 1	1
Trigger Input Pin 2	2
Trigger Input Pin 3	3
Trigger Input Pin 4	4
Trigger Input Pin 5	5
Trigger Input Pin 6	6
Trigger Input Pin 7	7

USEFUL TIP

In order for factory preset to be triggered, copy the settings of the desired preset in the user preset section.

KEYBOARD LOCK

To prevent unauthorized local access, the DB6400 offers password protected keyboard locking. By default the keyboard is unprotected. To enable this function, using the front panel navigational menu, go to *Settings> Security> Front Panel*, then press [OK] and **Enable** the *Access Control* function. Set the preferred 5 digit password and *Access Timeout*.

Once the keyboard lock function is enabled, every attempt to use it will require a password: ENTER PASSWORD: 0****. Access will be denied upon false entry.



KEYBOARD UNLOCK

If the Keyboard unlock function has been activated by mistake, try to unlock it using the default password **01234**. In order to deactivate the code protection, once the front panel menu is unlocked follow the menu path *Settings> Security> Front Panel> Access Control* and then select **Disabled**.

If you do not manage to unlock the front panel with the default password, nevertheless whether it has been changed intentionally or not, DB6400 should be returned to its factory defaults in order for the password security to be disabled.

NOTE: The password consists of 5 digits. The leading zeroes are not shown in the menu, but should be specified when entering the unlock password. For example, if your password is 123, when entering the password 00123 should be written.

RDS

This menu allows you to turn **On** or **Off** the **RDS Encoder** and set the **RDS Level**. Also, all elements of the Basic and Dynamic RDS/RBDS are gathered in this menu – PI, PS, RT, TA/TP, DPS and etc. A list of alternative frequencies is also available. Each of the 25 AF (Alternative frequencies) are user defined and can be assigned via the front panel navigational menu.

Another great feature is that the **Radio Text** and **DPS** can be also edited via the front panel menu. In order for this to happen, once the relevant menu is selected, the [OK] button should be pressed so that the text could be edited. Use the [UP] and [DOWN] keys to navigate through the alphabet. Press [Insert] to save the new text.



DAYPARTING

Dayparting is the practice of dividing the day into several parts, during which a different type of audio preset to be used for the audio processing. This function will allow a processing pattern based on the radio's timetable to be made.

The menu path (using the front panel menu) is **Menu> Settings> Dayparts**. Then press [OK] to enter the menu. This subsection contains all the real time clock controls for switching presets.



Enable the **Dayparting** function in order to use it. There are nine positions at your disposal that can be set. Select one of them and press [OK] to enter the settings menu. Set the desired **Daypart Week Day**. For your convenience, the option **Every day** is also available through the same menu. Set the **Start Time** and **Daypart Duration**. Then, to finalize the set-up, select the preset that should be used during this time period. Repeat the same procedure for each of the positions that should be used.

Other sections

STEREO

All needed settings in order for your station to be broadcasted in stereo are applied through here, thus allowing more natural distribution of the sound.



STATUS

Information on the device's status, IP address, etc. can be found here.



Factory and User presets

FACTORY PRESETS

The DB6400 has an extensive set of factory presets and provision of 20 user ones. In order for a preset to be selected/used, navigate to the desired preset and press the soft button labeled [Load], and then [OK].

How to create and save a User Preset or How to customize your sound

As the factory presets cannot always suit every format and market, each of them can be used as a basis for the creation of a new user-defined preset. Once you are satisfied with the result all the changes could be saved.

IT IS RECOMMENDED the user presets to be created prior to the installation of the DB6400 in the broadcasting chain. Otherwise, any drastic changes of the audio quality and enhancements will be audible for the listeners.

The procedure is quite simple. Below you will find a step-by-step description of the process.

1. Start by choosing an empty preset, or a factory preset that you would like to use for a basis of the new one. The menu path is *Main screen* > *Presets* select preset and press the soft button labeled [Load], then [OK] to confirm the change;



2. Go back to the main menu and select the *Process* icon - modify the parameters that you think would improve the enhancement of your signal and will make your station's sound unique.



Specifying the new preset name is mandatory. If not, the DB6400 will not assign a name and the newly created preset will be saved as U10 : DANCE (for example, if a factory preset is used as a basis) or U7 : -empty- (if user preset is used as a basis).



3. Once you have finished with the creation of your customized sound/preset, go back to the *Presets* page and find the modified preset. An  symbol indicating that some changes are being made will appear.



4. In order to save the changes, using the front panel keyboard, select one of the user presets then press the [Save] button. A window requiring verification will appear. Confirm the changes by pressing the [OK] button. The newly created preset will be automatically chosen as 'active preset'.



NOTE: Unless the new preset is created by a qualified/experienced broadcaster, it is recommended no general changes to the base preset to be applied, as this can lead to unwanted signal distortion.

WEB Interface

DB6400 is also controlled through a built-in web server. A standard web browser can be used to monitor its status or to make some adjustments.

There are two options for access to the WEB Interface of DB6400:

- via a standard WEB Browser by specifying the device's IP address (the IP address should be manually identified first);
- via the Network discovery option.

MANUAL IP ADDRESS IDENTIFICATION

Connect the device to a local network or to the Internet by the applied LAN cable. Through the Front panel navigational menu pressing the [OK] button will enable you to enter the device main menu.

Using the [RIGHT] navigational button find the *Status* section located at the end of the menu. Press the [OK] Button to enter the *Status* section. Via the Front panel navigational menu press the [DOWN] button.

This operation will visualize the screen containing information about the IP Address of the device. Open a new WEB Browser and enter the device IP address in the address field then press [Enter].



NOTE: Due to the inability of some WEB Browsers to read the IP address format displayed on the screen of the device, the numbers included in the IP Address must be written without the leading zeros. For example: 192.168.020.095 must be written as 192.168.20.95

A window that requires *username* and *password* will appear.

Default values being - *username*: **user** or **admin**, *password*: **pass**

The image shows a web browser window displaying the login page for the DB6400. The title bar reads 'DB6400 - Advanced FM and Digital Radio 4-Band Processor' and the DEVA BROADCAST logo is in the top right. The page content includes a 'Welcome!' message, a 'Username:' label with an input field, a 'Password:' label with an input field, and a 'Login' button.

NETWORK DISCOVERY

This is a network setting that defines whether your computer can see (find) other computers and devices on the network and whether other computers on the network can see your computer. By default, Windows Firewall blocks network discovery but you can enable it.

1. Open Advanced sharing settings by clicking the Start button, and then on “Control Panel”. In the search box, type “Network”, click “Network and Sharing Center”, and then, in the left pane click “Change advanced sharing settings”;
2. Select your current network profile;
3. Click Turn on network discovery, and then click save changes.

NOTE: If you’re prompted for an administrator password or confirmation, type the password, provide confirmation or contact your system administrator.

If you have already enabled this function on your computer DB6400 will be automatically added to the Device list section. The device will be ready for usage and no additional adjustments will be required except user name and password.

ACCESS

DB6400 provides you with a protected access to the device settings. You can choose between two types of log in:

1. As an **ADMINISTRATOR** – it will give you full control over the settings (*username: admin, password: pass*);
2. As a **USER** – this type of log-in will allow you to monitor the device and to choose different stations without applying settings (*username: user, password: pass*).

In order to make the necessary adjustments to the device, please log in as an **ADMINISTRATOR**.

STATUS

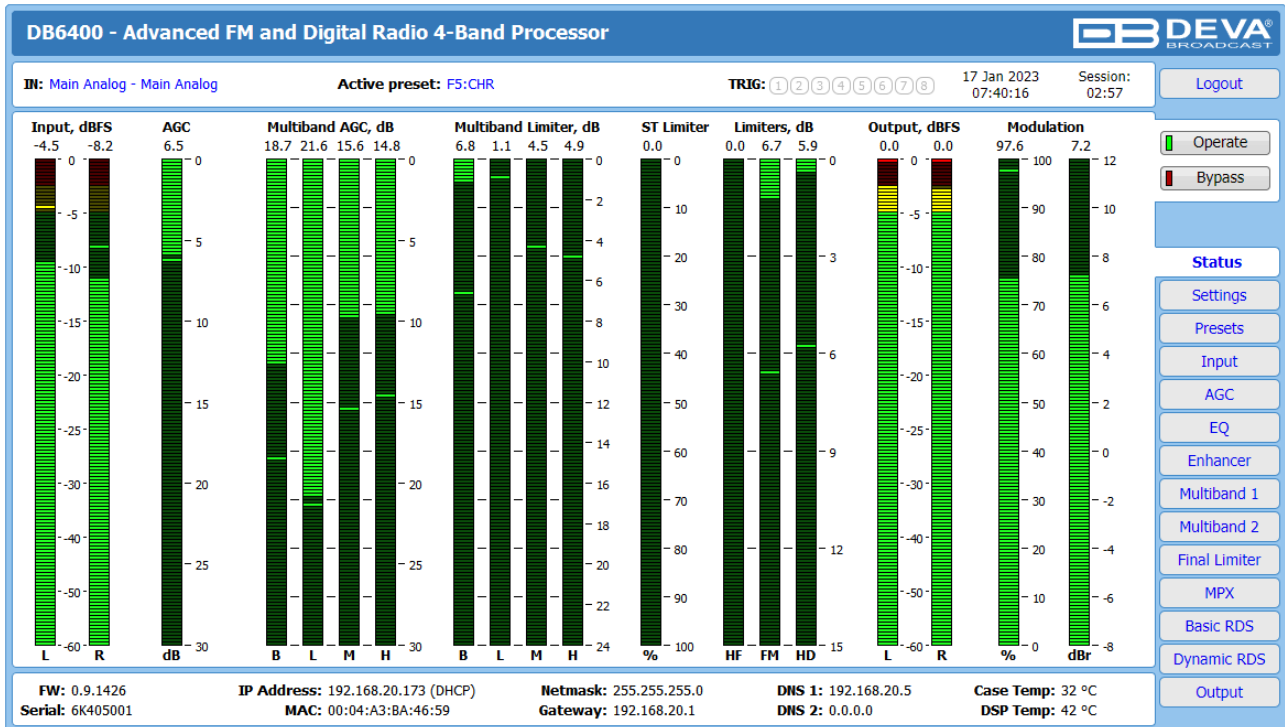

The *Status Screen* shows all mandatory parameters represented as LED readings, just as the ones placed on the front panel of DB6400. The LEDs sequence is arranged as per the processing path.

In order for DB6400.'s processing powers to be evaluated, and the difference between the processed and raw signal to be clearly heard, there is an incorporated [Bypass] option in the form of a button. When the [Bypass] option is enabled, the entire process will be stopped.

At the top of the control window is placed a constant section, containing information about the input in use, active preset, Trigger port status (if a factory preset is activated via the trigger port, the relevant number will be lit), Date/Time and Session Timeout.

At the bottom of the control window is an information bar, gathering all the important connection parameters – Firmware Version in use, Serial Number, IP Address, and etc.

Upon change of the Web Interface screens, the main status window will resize automatically and become a constant part of each tab. Thus, allowing reading at a glance of all the mandatory parameters (*Settings* pages excluded).

SETTINGS

The *Settings* page is divided into several subsections. Each explained in details below.

General

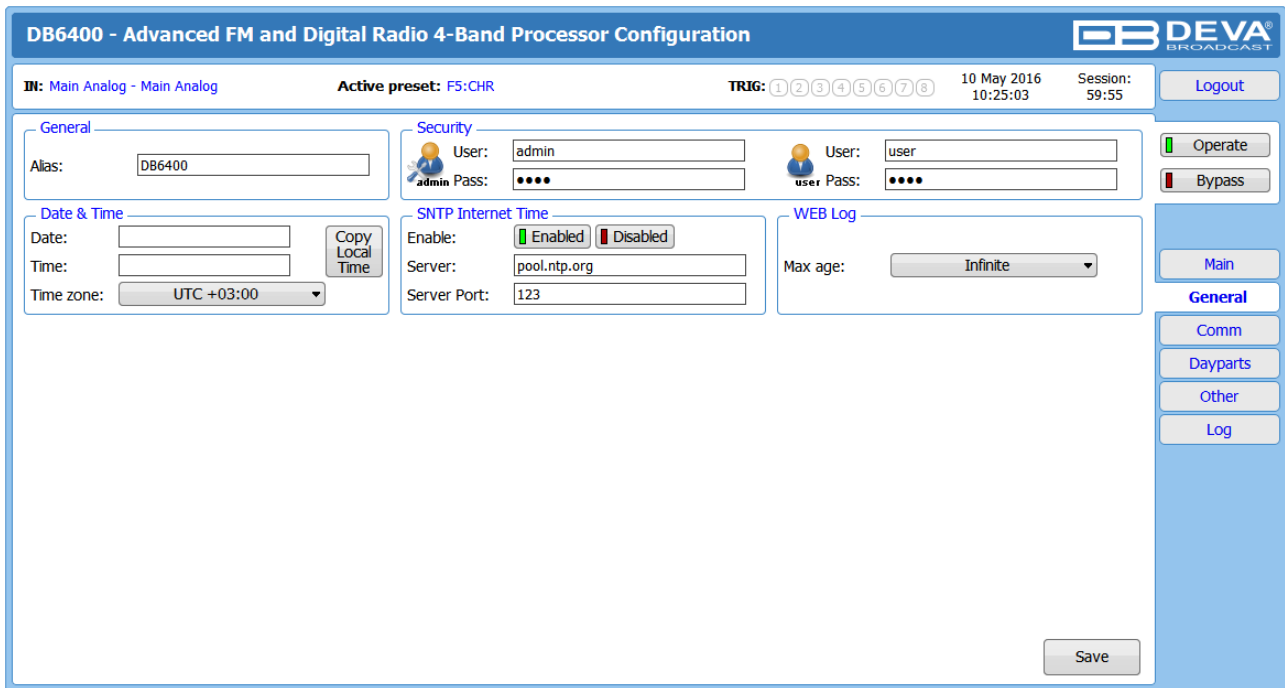

The screenshot shows the 'DB6400 - Advanced FM and Digital Radio 4-Band Processor Configuration' interface. The 'General' section is active, showing the following fields and options:

- General:** Alas: DB6400
- Date & Time:** Date: [empty], Time: [empty], Time zone: UTC +03:00, Copy Local Time button.
- Security:** Admin User: admin, Admin Pass: [masked], User: user, User Pass: [masked].
- SNTP Internet Time:** Enable: [Enabled], Server: pool.ntp.org, Server Port: 123.
- WEB Log:** Max age: Infinite.

Navigation buttons on the right include Logout, Operate, Bypass, Main, General (selected), Comm, Dayparts, Other, and Log. A Save button is located at the bottom right of the configuration area.

DB6400 provides you with protected access to the device settings. You can choose between two types of log in.

- As an **ADMINISTRATOR** – It will give you full control over the device’s settings;
- As a **USER** – that will allow you to just monitor the device, while all the settings remain locked.

In order for the security of DB6400 to be enhanced, new **username** and **password** could be set from the *Security* section.

By choice, you can change the name of the device (*General* section). Later on, it will be used as a title name on all WEB pages. Customizing the name will make the device more recognizable.

Date & Time – used for manually determining the current date and time. [Copy Local Time] button will set the *Date & Time* to correspond to that of your computer.

SNTP Internet Time – Synchronizes automatically DB6400’s clock time to a millisecond with the Internet time server. Enable this function in order to use it (Specifying the server closest to your location will improve the accuracy).

WEB Log – the maximum storage time of the log files is chosen from here. Log files older than the specified will be permanently deleted.

NOTE: In order the applied settings to be used press the [Save] button, placed on the bottom right part of the screen.

Communication

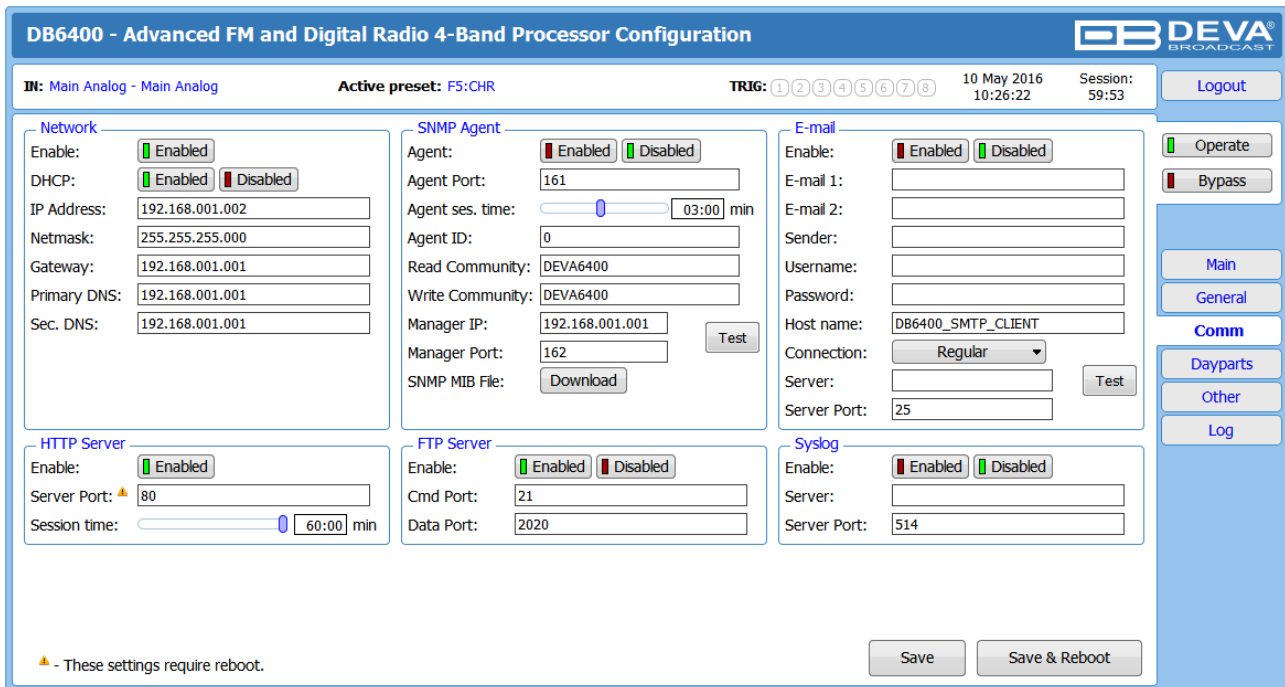

The screenshot shows the configuration page for the DB6400 processor. The title is "DB6400 - Advanced FM and Digital Radio 4-Band Processor Configuration". The interface includes a navigation menu on the right with options like "Operate", "Bypass", "Main", "General", "Comm", "Dayparts", "Other", and "Log". The main content area is divided into several sections:

- Network:** Includes fields for IP Address (192.168.001.002), Netmask (255.255.255.000), Gateway (192.168.001.001), Primary DNS (192.168.001.001), and Sec. DNS (192.168.001.001). There are "Enabled" and "Disabled" buttons for the network settings.
- SNMP Agent:** Includes fields for Agent Port (161), Agent ses. time (03:00 min), Agent ID (0), Read Community (DEVA6400), Write Community (DEVA6400), Manager IP (192.168.001.001), and Manager Port (162). There is a "Test" button and a "Download" button for the SNMP MIB File.
- E-mail:** Includes fields for E-mail 1, E-mail 2, Sender, Username, Password, Host name (DB6400_SMTP_CLIENT), Connection (Regular), Server, and Server Port (25). There are "Enabled" and "Disabled" buttons and a "Test" button.
- HTTP Server:** Includes fields for Server Port (80) and Session time (60:00 min). There are "Enabled" and "Disabled" buttons.
- FTP Server:** Includes fields for Cmd Port (21) and Data Port (2020). There are "Enabled" and "Disabled" buttons.
- Syslog:** Includes fields for Server and Server Port (514). There are "Enabled" and "Disabled" buttons.

At the bottom, there are "Save" and "Save & Reboot" buttons. A note at the bottom left states: "▲ - These settings require reboot."

Network

The network addresses could be set manually (static IP) or automatically via a **DHCP Server**. To set static **IP**, **MASK**, **GATEWAY** and **DNS** addresses, the **DHCP** should be disabled. In order for the built-in **DHCP** client to be activated, the function should be enabled. When the **DHCP** client is activated, all assigned values will be shown in the relevant fields on the "Status Screen". If due to any reason, the DHCP procedure cannot be completed, DB6400 will use Auto IP and will generate an **IP Address**.

SNMP Agent

Specify **Agent ID**, **Agent Port**, **Read/Write Communities**, **Manager IP**, **Manager Port** and **Session Timeout**.

Agent – enables/disables SNMP Agent.

Agent ID – is used for identification of the device among others, when an SNMP notification is being sent.

Once all needed settings are applied, use the Test button to generate a test notification, which upon success will be received by the SNMP Manager.

Press the [Download] button to download the latest available DB6000 SNMP MIB file.

NOTE: The MIB file may vary from one firmware revision to another. Downloading this file from the device, guarantees that you have the proper MIB file.

E-mail

Enter the desired notification recipients in **E-mail 1** and/or **E-mail 2** fields. Fill in your e-mail account settings: **Sender**, **Username** and **Password**, **Server**, **SNMP port** and **Connection Type**.

We recommend you to use the [Test] button and generate a test e-mail, which upon success will be delivered to the specified **E-mail 1** and/or **E-mail 2**.

Example of Test E-mail Message:

DB6400 Test Message.

Please do not reply to this e-mail.

HTTP Server

Enable/Disable the *HTTP Server*. Specify the *Server Port* and *Session Timeout*.

FTP Server

Enable/Disable the *FTP Server*. Specify the *Command* and *Data Ports* to be used.

Syslog

Enable or disable the *Syslog* feature. Specify *Server Address* and *Port* to be used.

Dayparts

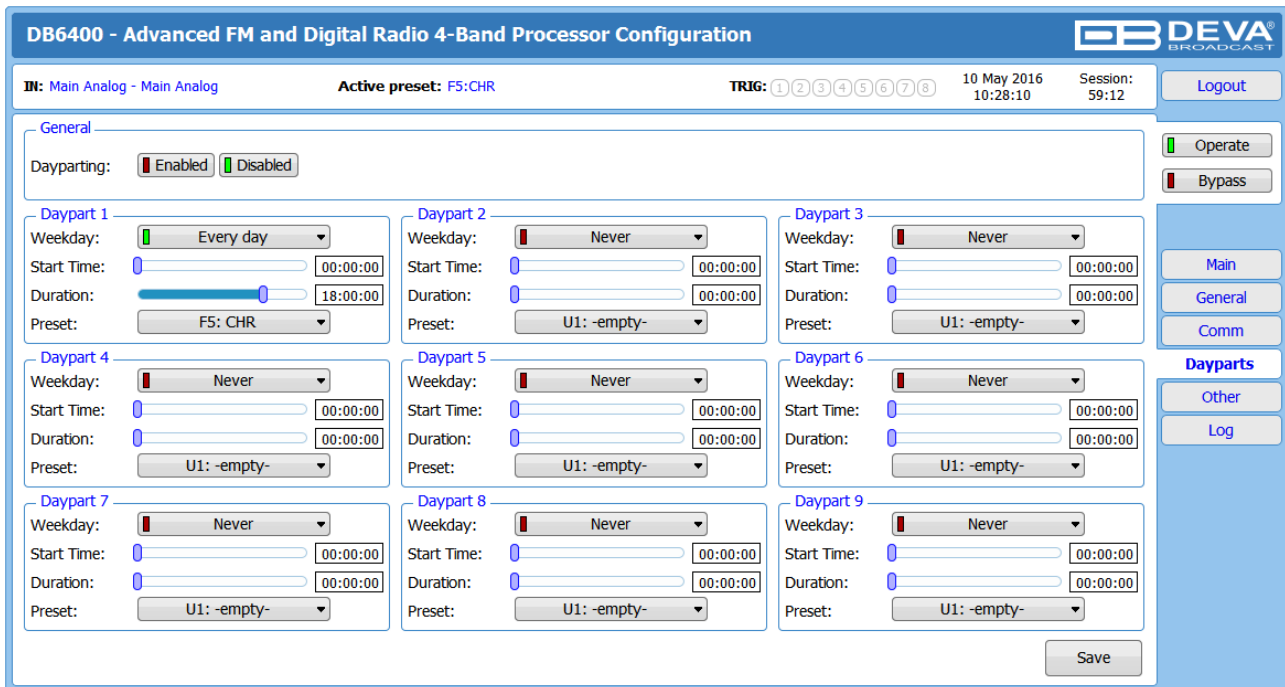

Dayparting is the practice of dividing the day into several parts, during which a different type of audio preset to be used for the audio processing. This function will allow a processing pattern based on the radio's timetable to be made.

Generally enable the **Dayparts** function in order to use it. Please bear in mind that if the option is generally disabled the function will not be used, nevertheless the applied settings in sections **Daypart 1** to **Daypart 9**.

There are nine positions at your disposal that can be set. The settings to be applied for each of them are identical:

1. Set the desired **Weekday** from the drop-down menu. For your convenience, the option **Every day** is also available;
2. Set the **Start Time** and **Duration**;
3. To finalize the setup, select the preset that should be used during this time period.

Repeat the same procedure for each of the positions that should be used.

NOTE: It is recommended the unused dayparts to be set to **Never**. Also, please note that if the **Weekday** is set to **Never** the relative daypart will not be used.

Other

The screenshot displays the 'DB6400 - Advanced FM and Digital Radio 4-Band Processor Configuration' web interface. At the top, it shows the active preset as 'F5:CHR', the date and time as '10 May 2016 10:28:51', and the session duration as '59:58'. The interface is divided into several functional areas: 'Firmware Update' with a file selection and upload button; 'Storage' showing used and free space with a format button; 'System Log' with a clear button; 'Factory Defaults' with buttons for retaining presets and IP; and 'Reboot Device' with a reboot button. A right-hand sidebar contains navigation buttons for 'Main', 'General', 'Comm', 'Dayparts', 'Other', and 'Log', along with 'Operate' and 'Bypass' buttons.

Firmware Update

To update the device firmware, select the new firmware file. After having pressed the [Upload] button, a dialog window will appear. Confirm the firmware update and wait for the process to complete.

Storage

Information about the device storage space is found in this section. The internal storage could be deleted by pressing the [Format] button.

System Log

By pressing the [Clear] button, all recorded in the system log information will be deleted.

Factory Defaults

[Retain Presets and IP] – all settings except for the Network settings (IP Address) and Presets will be deleted.

[Retain IP] – all settings except for the Network settings (IP address) will be deleted.

To restore DB6400 to its Factory Defaults you should first select the desired option and then press the relevant button. A new window will appear - confirm that you want to restore the factory defaults and wait for the process to be completed. On completion of the process, the settings should have the proper default values.

NOTE: When the device is returned to its factory defaults, the DB6400 will automatically use MP3 as current audio source. The device will return to its main audio source once it is restored.

Reboot

To start Rebooting of DB6400, press the [Reboot] button. A dialog warning window will appear. Confirm that you want to reboot the device and wait for the process to be completed.

Log

DB6400 - Advanced FM and Digital Radio 4-Band Processor Configuration



III: Main Analog - Main Analog
Active preset: F5:CHR
TRIG: 1 2 3 4 5 6 7 8
10 May 2016
10:30:24
Session:
58:25
Logout

2016-04-08 11:07:49	Control	Input Change, , Backup Active
2016-04-08 11:08:12	Control	Input Change, KATRA FM - #1 Hit Music Station in Bulgaria, Backup Active
2016-04-08 11:08:13	Control	Input Change, , Main Recovered
2016-04-08 11:08:16	Control	Input Change, , Main Recovered
2016-04-08 11:08:20	Control	WEB Logout, 192.168.20.54
2016-04-08 11:08:38	Control	WEB Login, 192.168.20.54, Admin
2016-04-08 11:11:56	Control	WEB Logout, 192.168.20.54
2000-01-02 05:02:17	System	Device is powered up
2012-01-01 00:00:01	System	Storage init OK
2016-04-08 13:16:53	Control	WEB Login, 192.168.20.54, Admin
2016-05-09 08:52:22	Control	Input Change, , Main Recovered
2016-05-09 08:52:22	System	Device is running
2016-05-09 08:52:23	System	Storage init OK
2016-05-09 09:00:28	Control	Input Change, , Main Recovered
2016-05-09 09:00:28	System	Device is running
2016-05-09 09:00:29	System	Storage init OK
2016-05-10 07:02:41	Control	Input Change, , Main Recovered
2016-05-10 07:02:41	System	Device is running
2016-05-10 07:02:42	System	Storage init OK
2016-05-10 07:03:35	Control	WEB Login, 192.168.20.179, Admin
2016-05-10 07:03:59	Control	Input Change, Main Analog, Main Recovered
2016-05-10 07:09:57	Control	Preset Change, F5:CHR, User selected
2016-05-10 10:19:29	Control	WEB Logout, 192.168.20.179
2016-05-10 10:20:03	Control	WEB Login, 192.168.20.35, Admin
2016-05-10 10:21:11	Control	WEB Logout, 192.168.20.35
2016-05-10 10:21:19	Control	WEB Login, 192.168.20.35, Admin
2016-05-10 10:22:36	Control	WEB Logout, 192.168.20.35
2016-05-10 10:22:42	Control	WEB Login, 192.168.20.35, Admin

Operate

Bypass

Main

General

Comm

Dayparts

Other

Log

All device system events (front panel and WEB activity, presets change) are stored here.

PRESETS

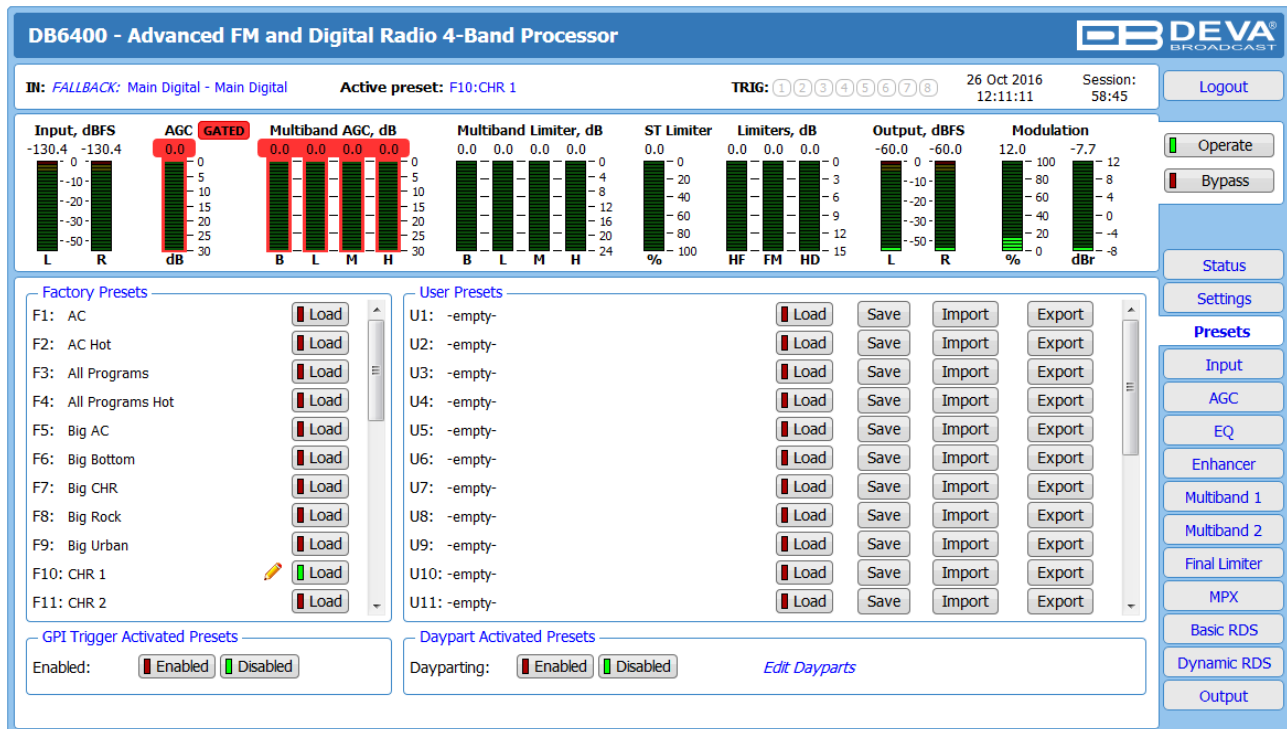

The DB6400 has a set of 27 factory presets and provision of 20 user ones. A preset contains all the audio processing path parameters that can be changed in the following tabs – *AGC*, *EQ*, *Enhancer*, *Multiband 1*, *Multiband 2*, and *Final Limiter*. In order for a preset to be selected/used, the [Load] button should be pressed (the active preset is illuminated in green).

Each of the factory presets can be used as a basis for creation of new user-defined preset. Once you are satisfied with the result all the changes could be saved.

If the *Presets* are to be triggered via GPI, the option should be enabled via the relevant menu. The same is applicable for the *Dayparting*. Edit dayparts is a shortcut to “[Dayparts](#)” settings page.

How can a user preset be made?

IT IS RECOMMENDED the user presets to be created prior to the installation of the DB6400 in the broadcasting chain. Otherwise, any drastic changed of the audio quality and enhancements will be audible for the listeners.

The procedure is quite simple. Below you will find a step-by-step description of the process:

1. Choose an empty, or factory preset that you would like to use for a basis of the new one;
2. Modify the parameters that you think would improve the enhancement of your signal and will make your station’s sound unique;
3. Once you are satisfied with the result, go back to the *Presets* page. You will notice that in front of the currently selected preset, a ‘pen symbol’ indicating that some changes are being made will appear. In order to save the changes select one of the user presets and press the [Save] button. The following message box will appear:

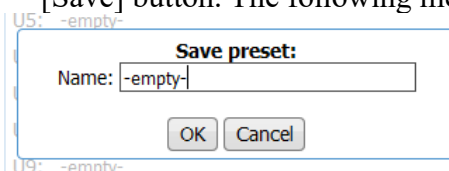

Specify the preset name and press [OK].

4. A window requiring verification will appear. Confirm the changes by pressing the [OK] button;

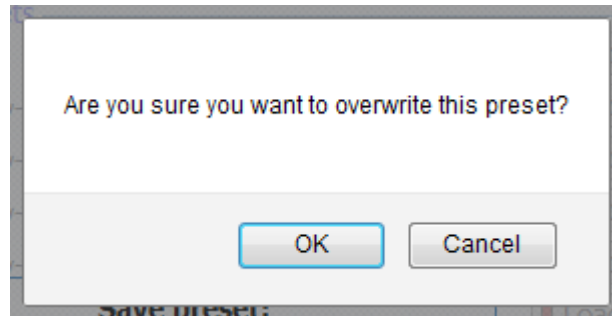

5. The newly created preset will be automatically chosen as 'active preset'.

NOTE: Unless the new preset is created by a qualified/experienced broadcaster, it is recommended that no general changes to the base preset (if such is used) to be applied, as this can lead to unwanted signal distortion.

Preset Lock

As many of the stations prefer to use the services of qualified personnel when creating the perfect preset, the DB6400 supports the function the newly created preset to be locked. The preset can be locked upon its export. The following options are available:

Key – the preset will be locked with a key known only by the creator. Thus, only users familiar with it would be able to import it into devices different than the one used for the purposes of creation;

Serial – you can specify the serial number of the device on which the preset can be used. Only the unit with this serial number will be able to import this preset. If the preset should be used only by the current device, press [This device] button and the serial number will be automatically assigned.

Depending on your preferences, both, one or none of the above explained options can be used.

Presets Export

In order for a user preset to be exported the following procedure should be completed:

1. Select the preset to be exported via the [Export] button. The following message box will appear:

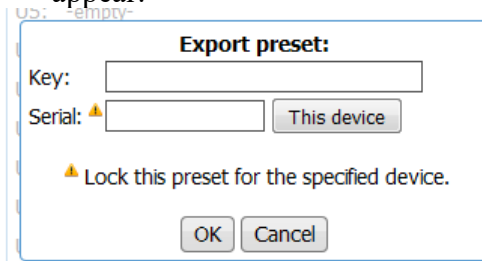

2. If the preset is to be lock – complete the needed information. If not, press the [OK] button to continue;
3. Confirm to save the file on your computer.

Presets Import

1. Press the [Import] button on the desired position. The following message box will appear:

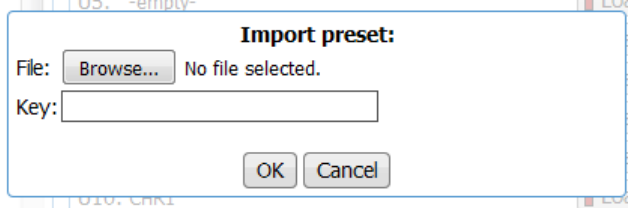

2. Browse the file to be imported and specify **Key** if it has been locked. Then press [OK] to continue;
3. The newly uploaded preset will be automatically chosen as 'active preset'.

If the preset has been protected by password, or has been assigned to a specific device (via the **Serial** function) the following message will appear:

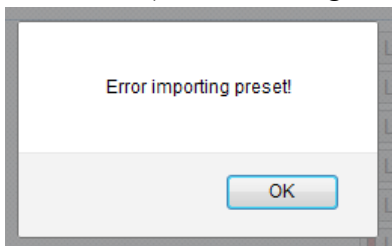

The same message will appear if the file is corrupted.

Presets Delete

The user presets can be changed or overwritten, but not deleted.

INPUT

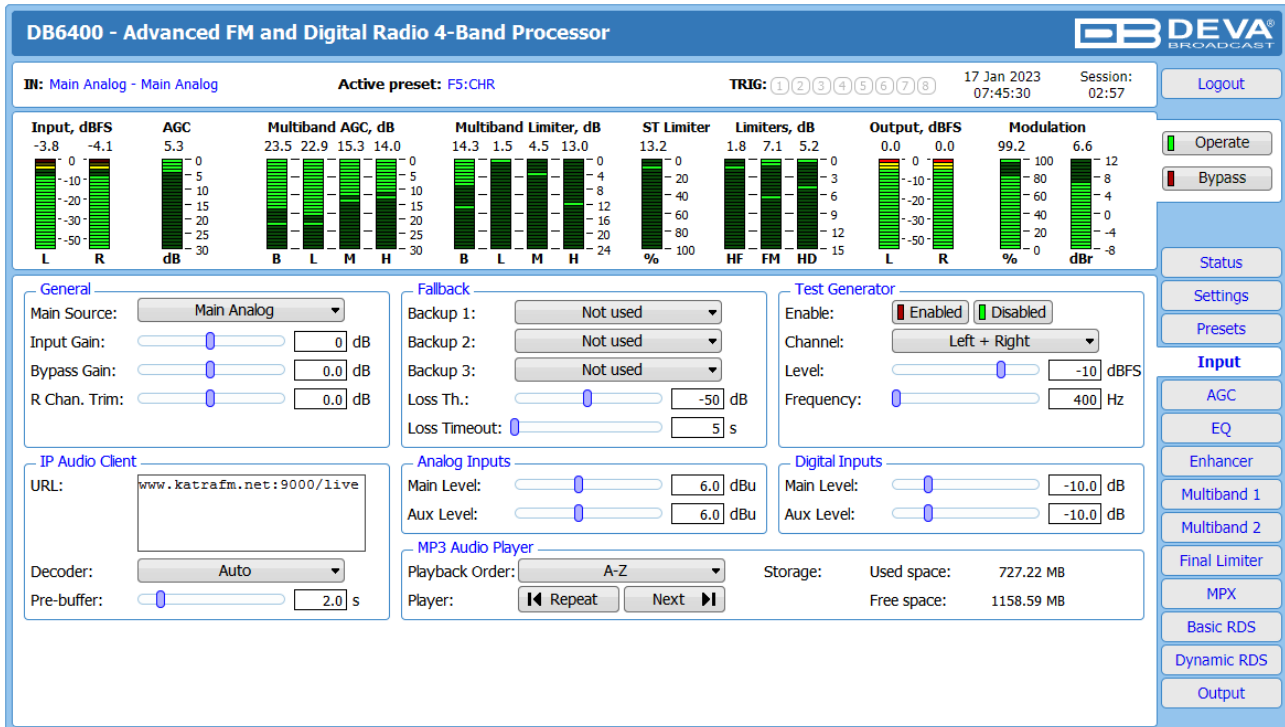

General – Several types of Main Audio Sources could be set – **Main Analog**, **AUX Analog**, **Main Digital**, **AUX Digital**, **MP3 Player** and **IP Stream**.

When setting the **Input Gain** level, have in mind that the applied settings have influence over the processed signal after the Input bargraph, thus meaning that the bargraph values will not change when altering the value of the Input gain.

Fallback – DB6400 supports up to 3 fallback sources. In order for a source to be used a backup should be specified. The following options are available - **Main Analog**, **AUX Analog**, **Main Digital**, **AUX Digital**, **IP Audio Client**, **MP3 Player**. The conditions when backup source has to be used should also be specified (**Loss Threshold** and **Loss Timeout**). This is how the backup works - upon loss of the Main source, the device will switch to Backup 1. If Backup 1 fails also, the DB6400 will switch to Backup 2 and etc. The DB6400 does not return to the previous source if it is restored. When the Main source signal is restored the DB6400 will automatically switch back to it.

Test Generator – There are several modes of operation – **Left+Right**, **Left-Right**, **Left**, and **Right**. Set the **Level** and the **Frequency** of the signal at which the generator should process. The ‘Test Generator’ will generate a test signal with which the DB6400 and the equipment connected to its outputs could be examined.

IP Audio Client – Set **Decoder** from the drop-down menu, and **URL** of the stream server.

- **Decoder** (+ Sample rate) – Select decoder and sample rate. It can be set to **Auto** or set manually to preferred decoder and sample rate. In Auto Mode, the DB6400 will adjust decoder and sample rate, using stream supplied information. For **PCM (uncompressed)** sample rate can be **32**, **44.1** or **48** kHz. For **MPEG1** the sample rate is determined automatically from the stream.
- **Pre-buffer** – The minimum amount of time in which the unit will prebuffer before playing starts in order for problems with the connection to be prevented.

Analog/Digital Inputs – Set the peak levels of the analog/digital inputs. This corresponds to the absolute maximum level that the input could receive i.e. the user guarantees that the fed level will not exceed the one specified. The specified level in dBu corresponds to 0 dBFS. Levels can be set for each input. For the analog input, 2 input level ranges are available, +12 or +24 dBu, set

with jumpers directly on the sound processing board.

MP3 Audio Player – The *Playback Order* can be changed from here. The following options are available: **A-Z**, **Z-A**, **Shuffle**, **Playlist**, and **Shuffled Playlist**. Information on the used and available SD card storage respectively, could also be found in this section. [Repeat] and [Next] button to navigate through the playlist if need be, are also available.

MP3 Files Upload via FTP –Through the use of a standard FTP client, you have the opportunity to update the backup content at will via any PC. The supported format is .m3u. An important requirement for the MP3 Player configuration is that all MP3 files should be stored in a folder named Audio (no sub-folders are allowed). The folder should be located in the root of the SD Card. The playlist file must be named playlist.m3u.

For information on how the connection between the DB6400 and an FTP Client should be configured, please [refer to “Download files via FTP” on page 79](#).

IMPORTANT NOTE: Use a plain text editor to create a file named playlist.m3u.

AGC

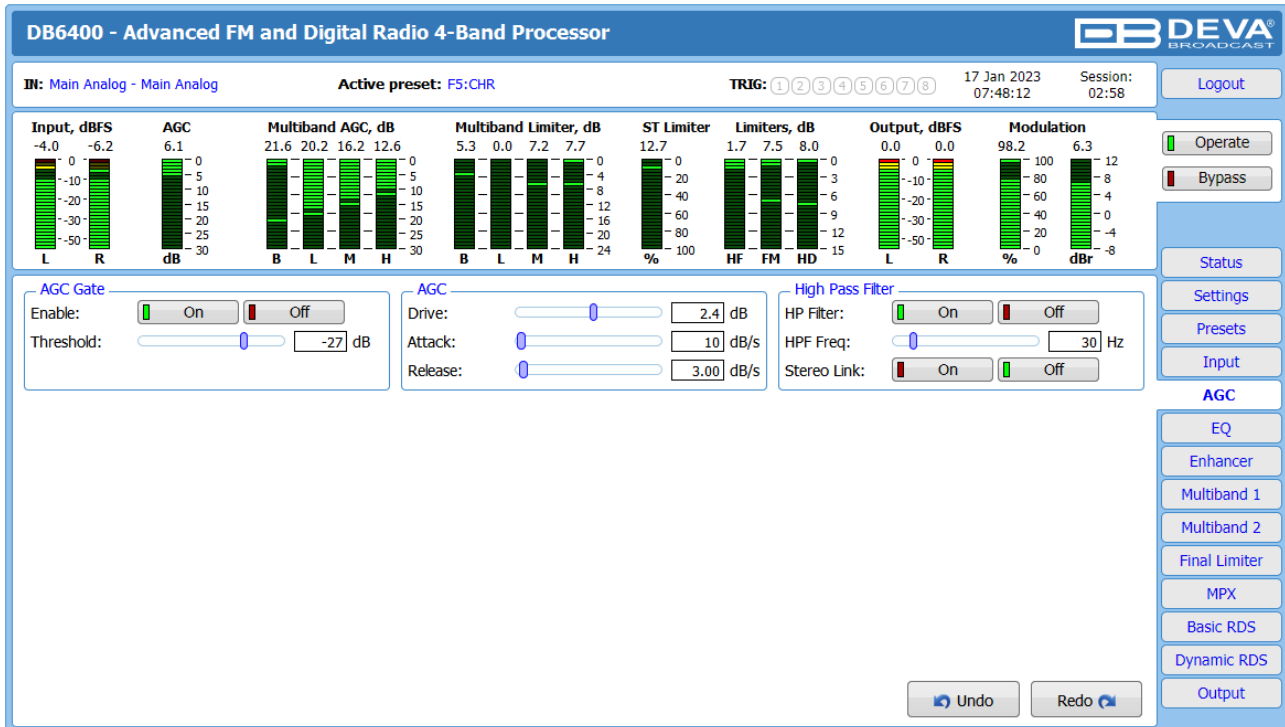

The first processing stage is the AGC. It works across a large band of frequencies, and is intended to normalize the difference in the audio levels fed at DB6400's input. The AGC effectively reduces the volume if the signal is strong and raises it when it is weaker. Having the task is to even out the variances and to create a consistent performance, the AGC has influence over all the subsequent processes.

AGC Gate – if turned [On], in the event of audio drops below the user set limit (in dB), this threshold will pause the operation of the audio processor. Hence limiting the unwanted floor noise when the signal is too low. GATED FLAG - the LED indicator (placed in the top section of the WEB interface) will be bordered in red, if the signal at the input is below the specified.

AGC – this section allows you to set the **Drive**, **Attack** and **Release**. When setting these parameters, have in mind:

- **Drive (dB)** – depending on the value set, it will increase or decrease the gain at the AGC input. Increasing the drive will compensate for the very low levels, and vice-versa - the low drive will prevent the low level corrections at the input.

- **Attack** – set in dB per second, this value will define the AGC's speed of reaction to unexpected volume increase.

- **Release** – sets the AGC correction speed in dB per second. It is not mandatory high **Release** speed to be set, as the AGC is powerful enough tool. It is widely recommended the speed to be set to 1dB/s and 1.5dB/s for classical music, and to 2dB/s for all other commercial programs.

High Pass Filter – this sections allows you to turn [On] and [Off] the HP filter that passes signals with a frequency higher than the set **HPF Freq** (High Pass Filter Frequency), and attenuates signals with frequencies lower than the set **HPF Freq** (High Pass Filter Frequency). If the **Stereo Link** is turned [On], the audio processor will check for differences between levels of the left and right audio channel, and if need be, will restore the levels at the output. This feature is very useful for jazz and classical programs, as when applied to pop/rock programs it may lead to sound power loss. A High-Pass filter is present at the processor input. With it, it is possible to minimize the following: The rumble, often present in infra-low and on microphone sources without bass frequencies limitations. Loudness loss due to spectrum occupation by infra-low that can only be heard on very large speakers. The High-pass filter can be set between 1 and 200Hz according to your needs.

[Undo] erases the last change applied to the settings reverting them to their previous state. Please note that not only the last applied setting will be undone, all settings that are not saved will be disregarded. The opposite of [Undo] is [Redo].

To save the changes switch to one of the other tabs of the WEB Interface.

EQUALIZER

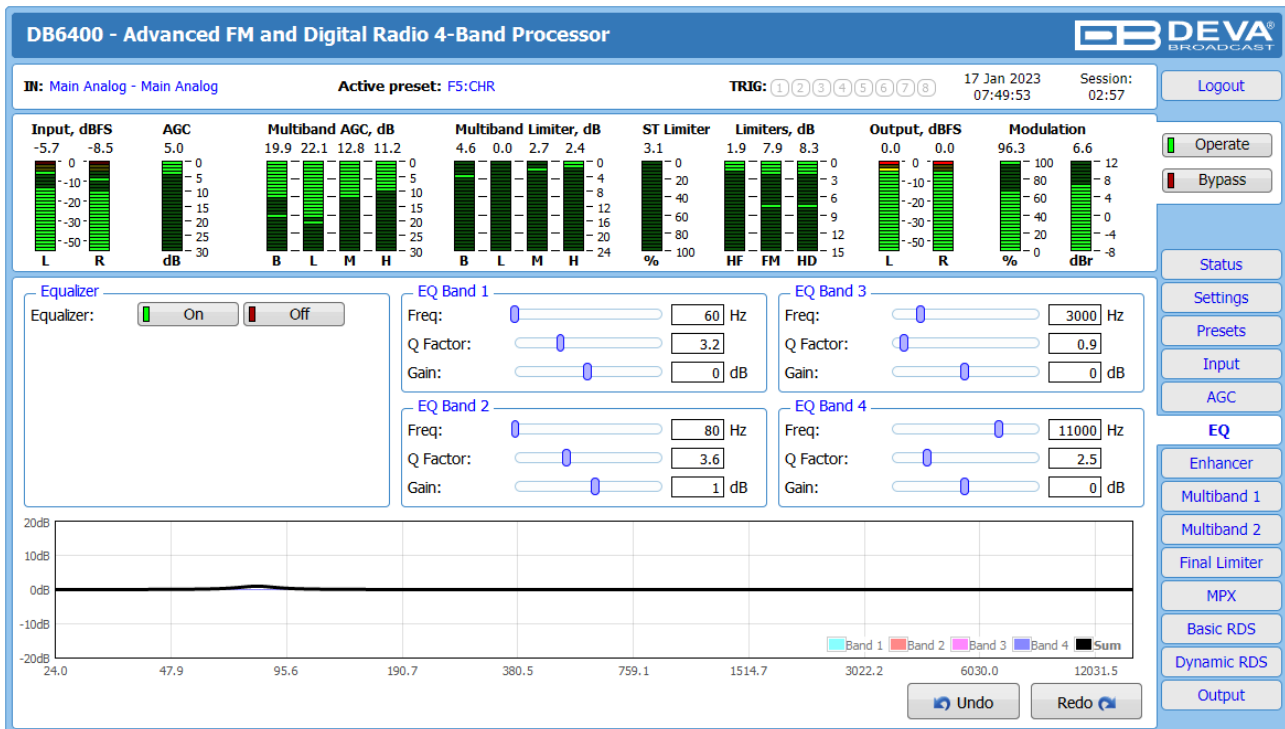

DB6400 has four separate sections of ‘parametric’ equalization, which can be attributed to any combination of *Freq* (frequency), *Q Factor* (bandwidth) and *Gain* (amplitude). These may be assigned to any combination of low frequency EQ, mid-band EQ and top-end EQ chores. However, all four sections are identical and each of them may be programmed in frequency between **50 Hz** and **15 kHz** (15 000 Hz). Of course, there is an option the equalizer to be enabled or disabled.

Within each section of parametric equalization, the *Freq*, *Q Factor* and *Gain* are individually adjustable. The sliders of the *EQ Section* panel select the frequency range, and identical ranges are available in each equalizer section.

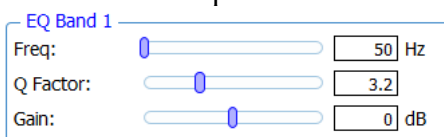

Freq – Parametric band center frequency;

Q Factor – Applied filter quality - width of the parametric band;

Gain – gain of the parametric band.

As each EQ slider is moved, the resultant change in response, both in that EQ section and its overall contribution, is shown on the graph, placed on the bottom of the tab. It displays the individual frequency response of each of the four equalizer bands and the summary frequency response of the entire EQ section, including pre-emphasis. Each band has a pre-defined color visible on the bottom right of the graph.

[Undo] erases the last change applied to the settings reverting them to their previous state. Please note that not only the last applied setting will be undone, all settings that are not saved will be disregarded. The opposite of **[Undo]** is **[Redo]**.

To save the changes switch to one of the other tabs of the WEB Interface.

ENHANCER

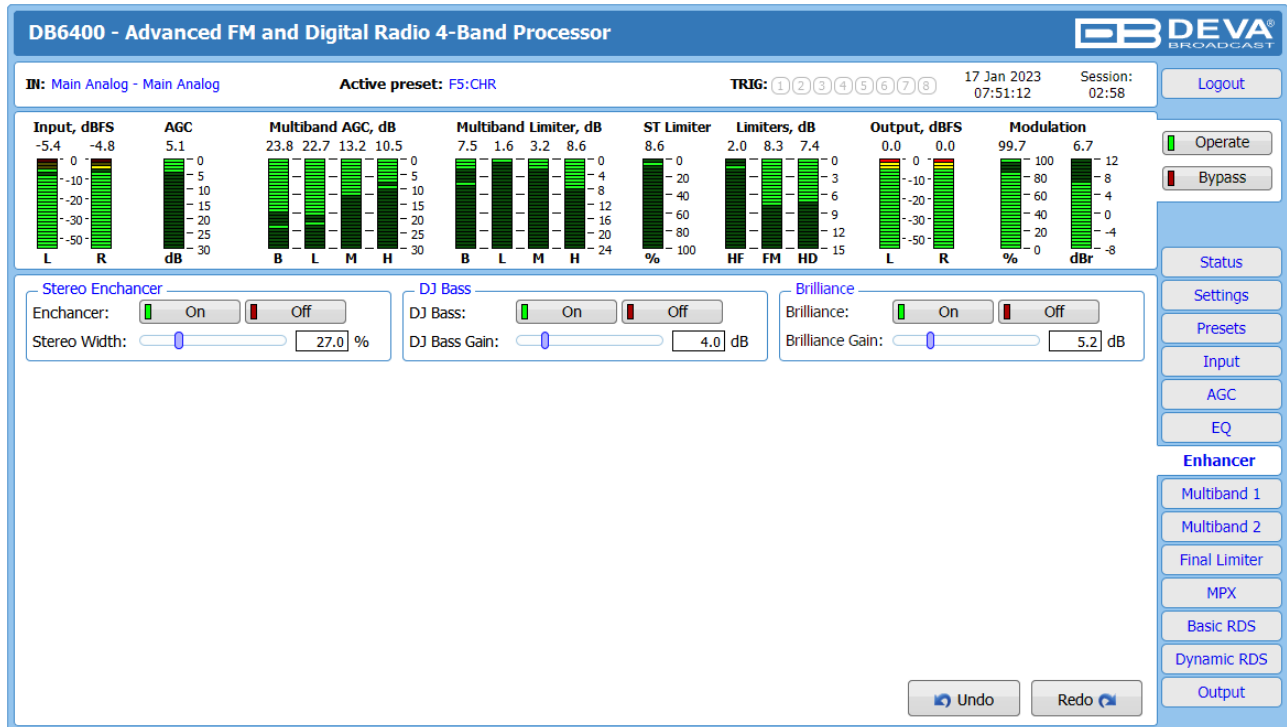

The DB6400 is equipped with real stereo enhancer intended to improve the existing stereo image. However, bear in mind that it will not create stereo from mono sources.

The **Stereo Enhancer** can be either turned [On] or [Off]. The **Stereo Width** parameter sets the stereo enhancement rate. The sufficient value widely recommended is between 20 and 40%.

DJ Bass can be either turned [On] or [Off]. It is intended to enhance the sound in the low-audio frequency range.

Brilliance can be either turned [On] or [Off]. It is intended to control the output level of the tweeter for proper relative volume between the treble and the low audio frequencies.

[Undo] erases the last change applied to the settings reverting them to their previous state. Please note that not only the last applied setting will be undone, all settings that are not saved will be disregarded. The opposite of [Undo] is [Redo].

To save the changes switch to one of the other tabs of the WEB Interface.

MULTIBAND 1 (MULTIBAND LIMITER)

The Multiband process is very powerful and can absorb the important sound variations. That is why is it not always necessary to use the AGC stage.

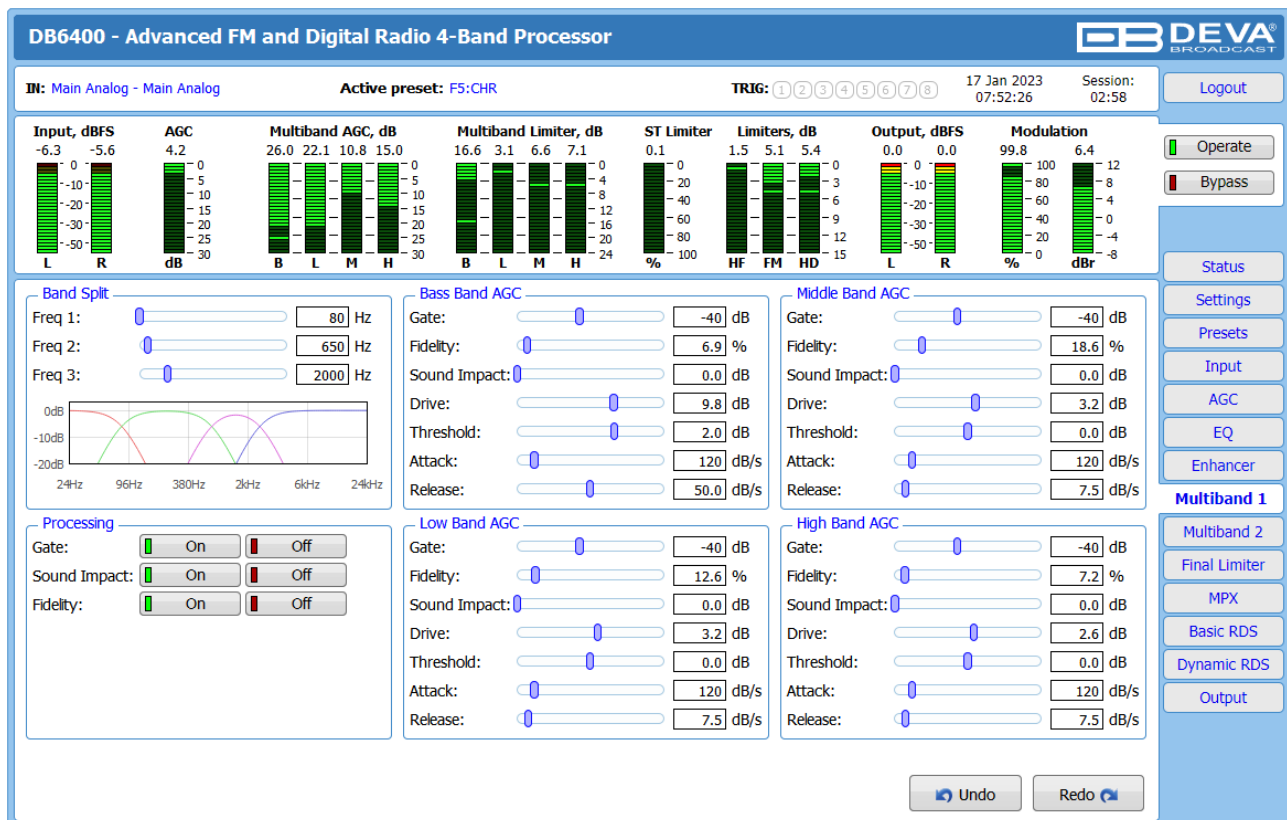

Split-band filtering is a great technique where audio signal can be separated into different frequency bands so that each band can be processed separately. Upon completion of the procedure, the respective bands can be combined together to form a more coherent and dynamic sound. Graphic visualization of the frequency bands is also available.

Processing – the multi band processing an unique algorithm that controls the gain in each band so as to assure sound stability. The [On] and [Off] buttons in this section enable or disable generally the *Gate*, *Sound Impact* and *Fidelity* options for the bass, low, middle and high bands.

Gate is intended to limit the noise coming from the low level. When the level is below the specified threshold in each of the band sections, the work of the bands will be frozen. When turned [OFF], the option will not be active and the noises could be audible.

Sound Impact gives the sound more “punch” and “impact” by dynamically adjusting the time constants on the incoming audio, and tracking for changes smaller than the value set in each of the band sections. If turned [OFF], the sound would become less punchy.

Fidelity is an option intended to maintain the fidelity and spectral balance of the original input signal. If turned [Off], the bands will be working independently.

The Multiband limiters (Bass Band AGC, Low Band AGC, Middle Band AGC and High Band AGC) are used to restrain in limits each of the bands to prevent distortion in the processing control system. Each of the parameters can be changed as per the user's requirements. The settings to be applied are identical for some of the subsections and are described in details below.

Gate – When the audio drops below this user defined threshold limit, the DB6400 will freeze operation band. When the signal is too low, this function will limit the floor noise. GATED FLAG - the LED indicator will be bordered in red, if the signal at the input is below the specified.

Fidelity – This function controls the spectral balance between bands. For example:

- if the **Fidelity** = 0%, the bands will work independently and the sound will be more colorful;
- if the **Fidelity** = 100%, the bands will be linked to the spectral distribution at the input, and the sound will be purer.

Sound impact – this option keeps the original authenticity of the sound attacks (peaks). Pay attention when using the **Sound Impact** with value bigger than 6dB, as the average power of the sound will be significantly increased. In such cases, you may need to lower the band limiter or final limiter drive.

Drive – it is intended to create more or less gain at the input of the band. When setting the drive, note that:

- Increasing the drive will lead to reduction in the gain created by the band process. This will make up for the very low levels;
- A very low drive will prevent low level corrections;
- If you are not using the wide band AGC, we recommend the drive to the bands to be pushed, so that the reduction to be sufficient and correct low levels.

Threshold – sets working limits for each band. It can also move bands from the background to foreground and vice versa.

Attack – Adjust in dB per second to set the processors' reaction speed for each band. When setting the attack parameter bear in mind that:

- If lower value is set, the slower will the processor react.;
- If higher value is set, the faster the processor will react, thus controlling the rapid variations.

Release – is often associated with density. The higher the release time is, the higher the spectrum density within the band will be. When setting this parameter, bear in mind that the Band processor is very powerful. Therefore, it is not necessary high release time to be set in order for high density levels to be obtained.

[Undo] erases the last change applied to the settings reverting them to their previous state. Please note that not only the last applied setting will be undone, all settings that are not saved will be disregarded. The opposite of [Undo] is [Redo].

To save the changes switch to one of the other tabs of the WEB Interface.

MULTIBAND 2 (MULTIBAND LIMITER)

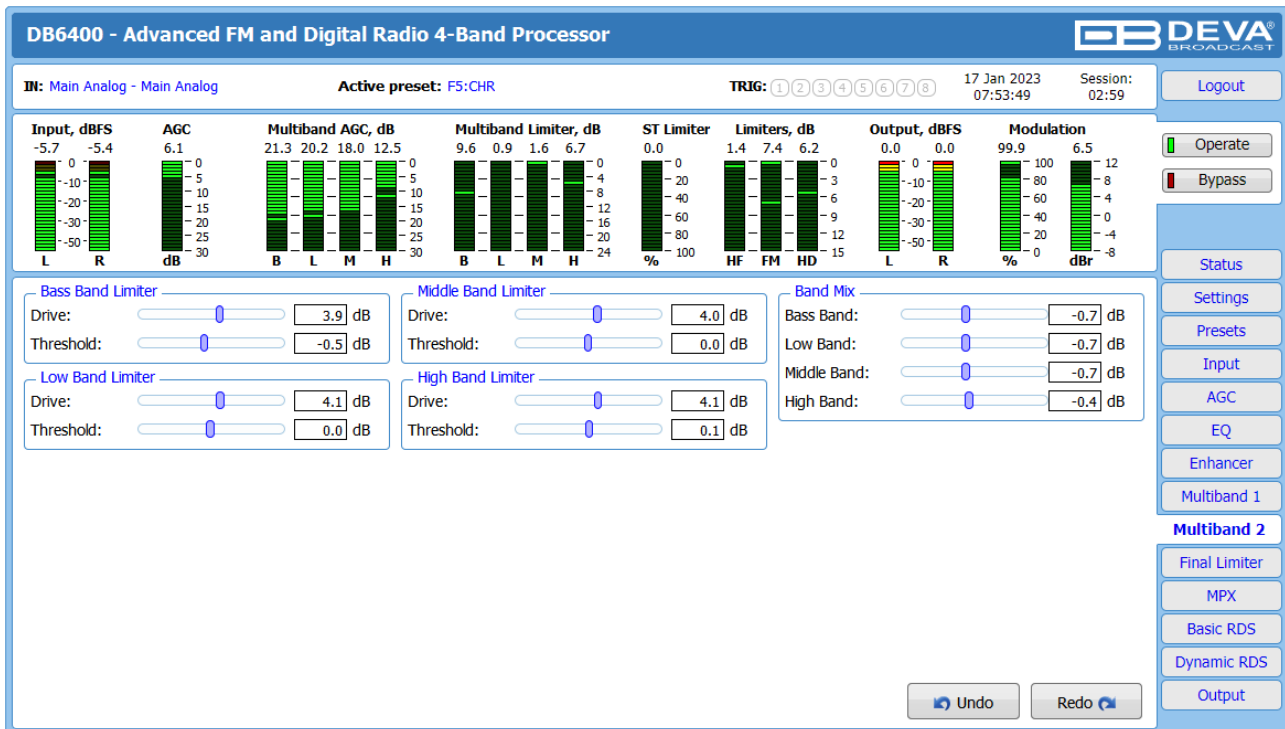

Multiband 2 (Multiband Limiter) is intended to prepare the processed audio for the final limiter using a powerful predictive algorithm. The applicable settings for each band have been simplified so as not to complicate the process with useless parameters. For each of the limiters (Bass Band Limiter, Low Band Limiter, Middle Band Limiter and High Band Limiter), user defined **Drive** and **Threshold** could be set.

The settings to be applied to each band are an “artistic” choice. Hence, there are no recommended values. When you set the preferred value, keep in mind that the more you limit the more the dynamics will be stabilized. However, the radios who prefer and count on the more natural sound are advised not to “limit” too much.

Drive – It is intended to create more or less gain at the band limiter input.

Threshold – sets the limit for each limiter band.

Band Mix allows you to dose the final balance - the output level for each band, hence, obtaining the best sound balance. If you decide to reduce or push a band, the output gain of band mix will be automatically compensated to avoid overload at the next stages.

[Undo] erases the last change applied to the settings reverting them to their previous state. Please note that not only the last applied setting will be undone, all settings that are not saved will be disregarded. The opposite of **[Undo]** is **[Redo]**.

To save the changes switch to one of the other tabs of the WEB Interface.

FINAL LIMITER

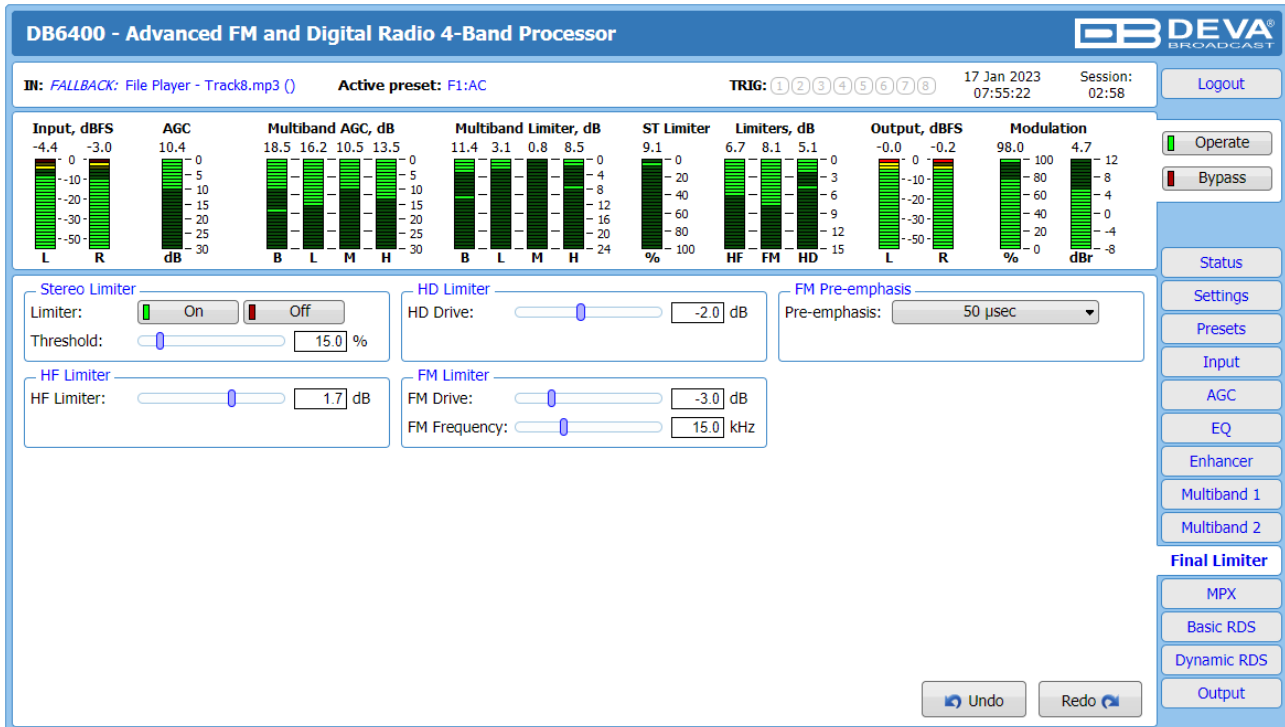

There are no recommended values for the Stereo, HF, HD and FM Limiters as they are a matter of choice. However, below are some basic recommendations:

Stereo Limiter – It is not recommended to be turned [Off]. Setting it to 10 - 15 % is a good starting point for multipath protection.

HF Limiter – set in dB the HF limiter is intended to increase or decrease the amount of high frequencies to be processed. This is a “drive” type of setting. The more you drive, the more the HF Frequencies will be stabilized. The difference will be felt most of the time in the low levels.

HD Limiter – Controls the gain at the HD Limiter input. It is developed and dedicated for high quality digital applications such as HD / DAB / DRM. This is a ‘Look-Ahead’ type of limiter. When used in this mode, the outputs are not limited to 15 kHz, and there is no pre-emphasis. The more you push the drive, the more you will get a loud and stabilized HD output.

IMPORTANT: When HD mode is used in FM application (pre-processor), always use final FM limiter before the exciter.

FM Limiter – the FM Limiter is intended for the FM applications. In its core, it is a very powerful clipper that controls the gain at the FM limiter input. The more you drive the limiter, the more MPX power will be gained. Bear in mind that increasing the FM limiter drive too much may lead to significant sound distortion.

FM Limiter modes change the knee of the limiter.

- [Smooth] – The sound has a round form before square shape, and is less aggressive;
- [Hard] – The sound has no knee in the form, and is more aggressive with more punch.

FM Pre-emphasis – set the preferred pre-emphasis type. This setting is applicable for the FM output only.

MPX

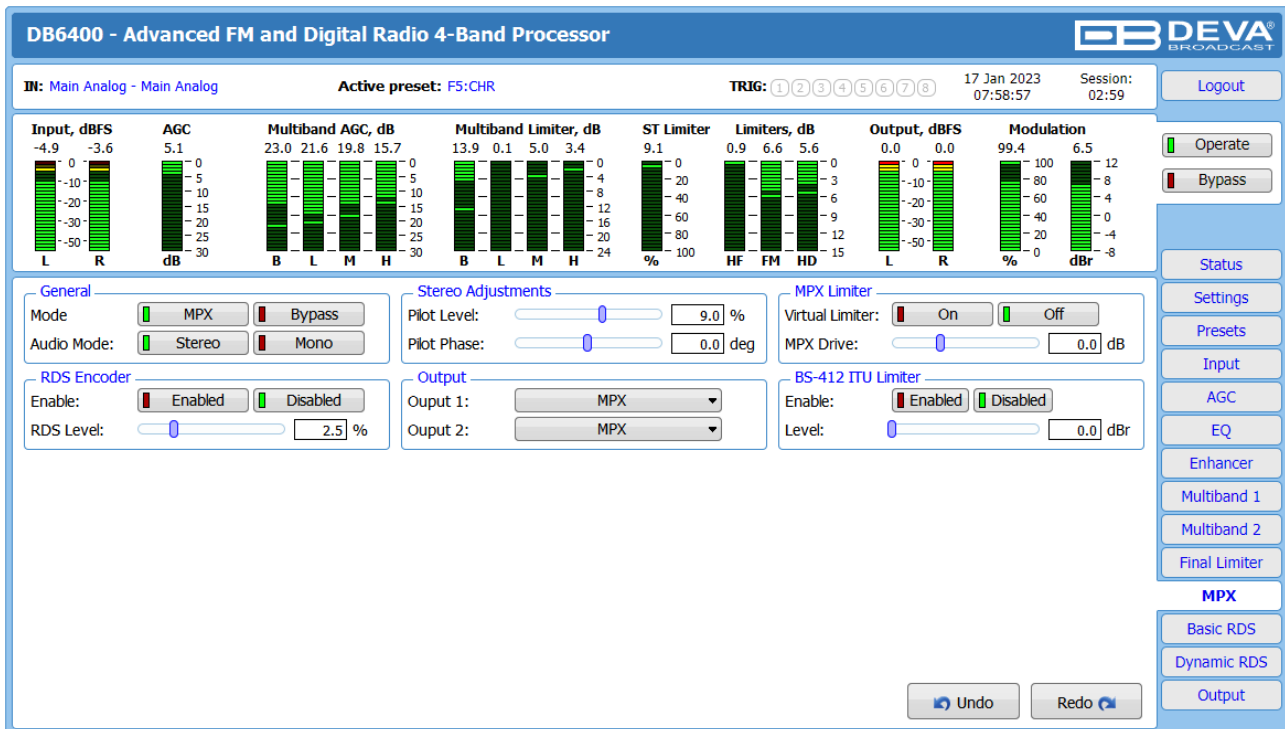

The settings of the Stereo generator are applied through this section of the WEB Interface.

General – three modes of operation are available. The output can be set to [MPX], [Stereo] and [Mono]. The option [Bypass] is also available.

Stereo Adjustment – from here you can change the level and phase of the PILOT tone.

MPX Limiter – from here you can turn [On] or [Off] the *Virtual Limiter*. The *MPX Drive* is adjustable from **0dB** to **10dB** via the interactive slider.

RDS Encoder – The DB6400 has a built-in RDS generator which, depending on your preferences can be [Enabled] or [Disabled]. The RDS subcarrier level can also be changed.

Output – Select the preferred output mode – [MPX+MPX] or [MPX+Pilot].

BS-412 ITU Limiter – Limits the MPX Power as per the ITU BS412 directive. The authorities in each country have set different parameters that should be observed. It is recommended your local authorization to be checked.

RDS DATA

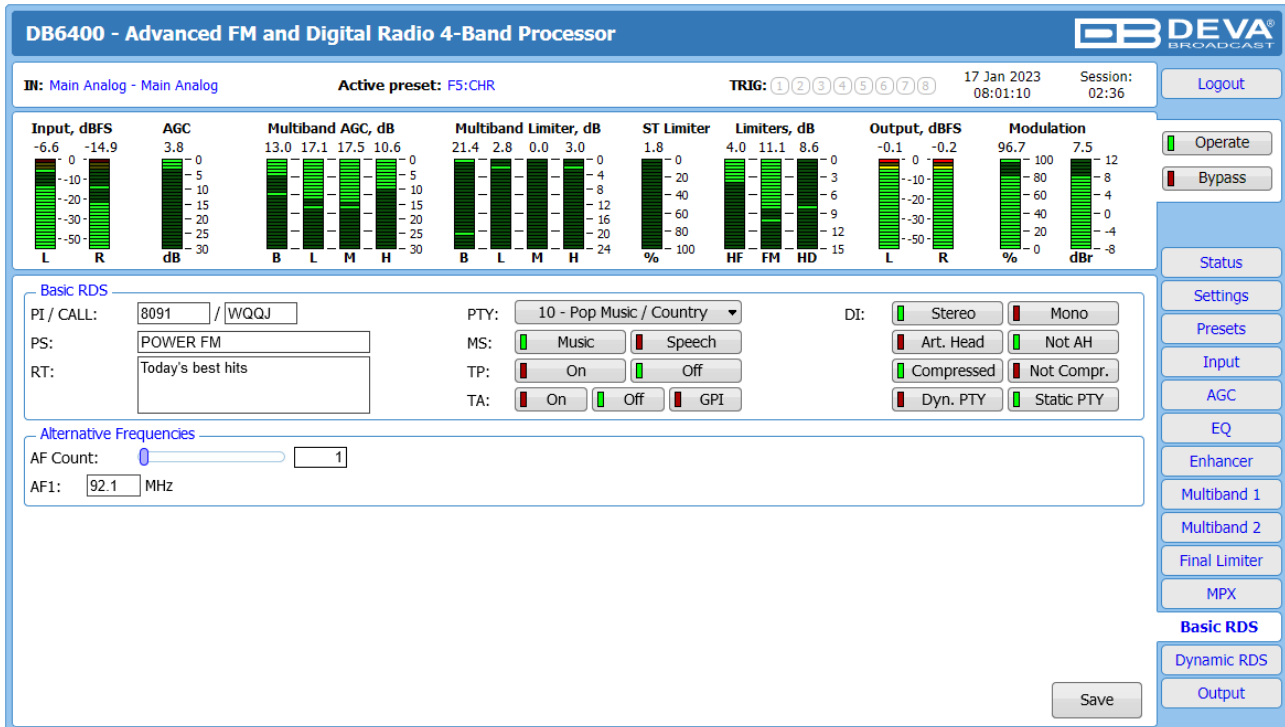

All basic elements of the RDS/RBDS are displayed on the screen – **PI**, **PS**, **RT**, **TA/TP** and etc. The **Alternative frequencies** are also available, represented as a list. The number of the **AF** can be set via the **AF Count Slider**. Once the needed quantity of AFs is set, the frequencies for each of them should be specified.

Basic RDS

PI/CALL (Program Identification) – The **PI** code is your station’s ‘digital address’. It is a hexadecimal code that is assigned by an appropriate broadcasting authority in most countries, but in the United States the **PI** code is numerically calculated from the station’s call sign. We have provided a calculator utility within the DB6400. An in-depth discussion of the mathematical calculation is given in RDS/RBDS Standard.

To use the **PI** calculator for US ‘K’ and ‘W’ call signs, simply enter call letters into the **CALL** box. The hexadecimal code will automatically be calculated into **PI** box. If the hexadecimal code for a US station is known, you may enter it under **PI**, and then the call sign will be calculated automatically into **CALL** box.

When **PI** calculator fails to calculate **PI** or **CALL** the corresponding box will be filled with ‘----’.

PS (Program Service Name) – This is the station’s “street name” that will appear on the receiver faceplate display. The **PS** can be up to eight characters in length (including spaces) and can be as simple as the station’s call letters: KWOW or KWOW FM, or a slogan: NEWSTALK or LIVE 95.

RT (Radio Text) – This is a 64-character block of plain text that the listener can select for visual display on the faceplate of the radio by pressing an **INFO** button on the receiver. This function is not available on many automobile radios for safety reasons, which has precipitated the frowned-upon practice of scrolling the **PS** field instead. The **Radio Text** can announce song titles and performers, run special promotions or contests, or broadcast sponsors’ messages.

PTY (Program Type) – The *PTY* data flag identifies the station format from a pre-defined categories. Many RDS receivers are able to seek the listener's preferred format automatically. This means that a car radio can switch from a fading station to a stronger one that carries the same variety of music, though not the very same program, as provided by AF switching. The *PTY* function of RDS helps a broadcaster catch 'transient audience' share. The *PTY* code is not meant to change from song to song or to accommodate a top-of-the-hour newscast, however.

MS (Music/Speech Switch) – This flag simply indicates whether music or speech is the primary broadcast programming.

TP (Traffic Program Identification) – The *TP* flag identifies the station as one that routinely broadcasts traffic bulletins for motorists as part of its normal, everyday programming. When the *TP* flag is displayed on the receiver faceplate, the radio is searching for traffic announcements. The radio keeps track of *TP* stations offering this service to speed up the search-and-switch process.

TA (Traffic Announcement) – This is a temporary flag added to the RDS data stream only when a traffic bulletin is being aired. Some RDS car radios can be set to search for traffic bulletins among various *TP* stations while tuned to a listener's preferred program, or even while playing a tape or CD. As soon as any *TP* station broadcasts a traffic bulletin, the receiver temporarily switches-over to receive it. When the bulletin is finished, the receiver switches back to the original program, tape or CD. *TA* flag can be set On/Off manually, or alternatively can be externally controlled via GPI trigger pin 8.

DI (Decoder Information) – This is one of several 'flags' that convey yes/no or other very basic data. This particular flag tells the receiver whether the broadcast is monaural, or is being transmitted in any of several methods of stereo or binaural broadcasting.

List of Alternative Frequencies – A network broadcaster, or one with low-power rebroadcast transmitters (translators) to fill holes in his coverage area, can include a list of all frequencies where the identical program can be heard simultaneously. The RDS receiver (particularly the upscale car radio) constantly searches for the best signal that carries the very same program. When a better signal is found, the radio re-tunes with no noticeable interruption. The principal utility of this RDS function is with European radio networks and US stations with 'translators.'

Dynamic RDS

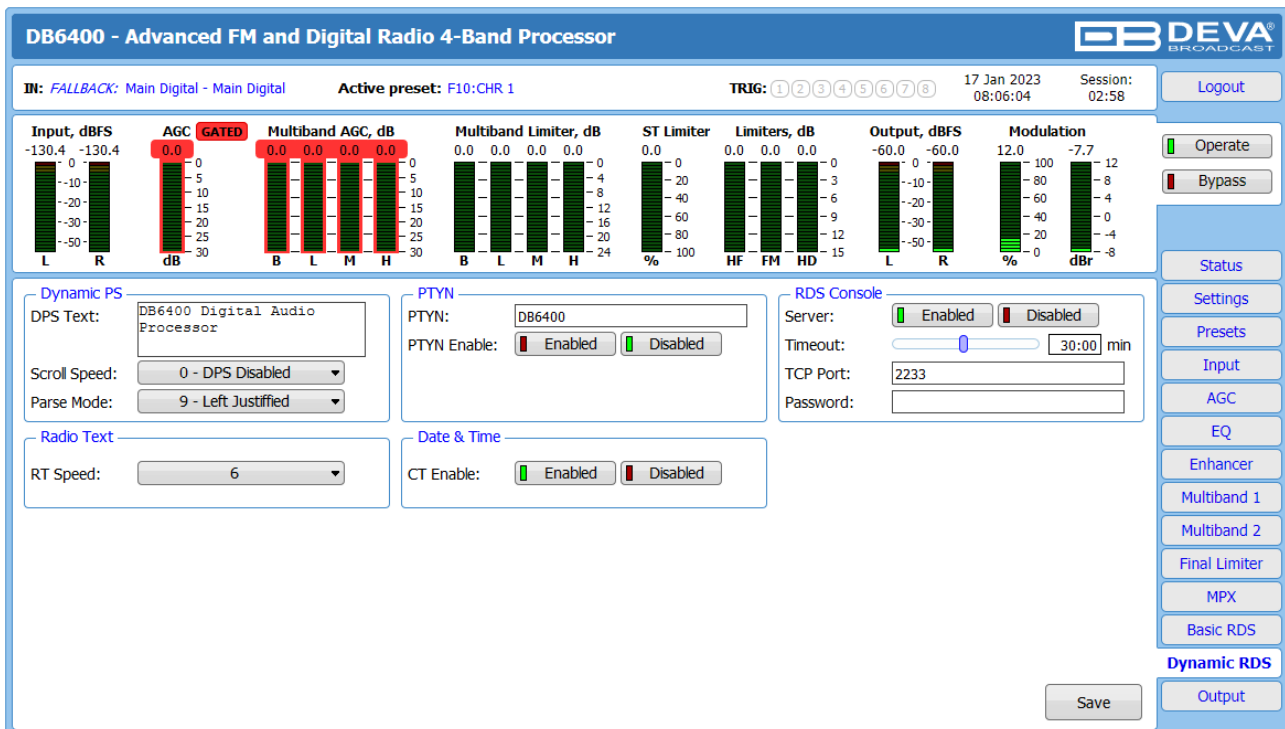

Dynamic PS ‘marches’ the message across the display screen one character at a time. The message requires a much longer transmission time in this mode, but a glance at the radio display a few seconds still allows the driver to get the full message without missing words.

Scroll Speed – The speed of dynamic PS messaging is set here, or dynamic PS messaging can be turned off entirely. When **0 - DPS Disabled** is selected, the dynamic PS message remains in the nonvolatile encoder memory, but only the 8-character default static “street name” typed into the PS field (Basic RDS) will be displayed on the receiver faceplate. Setting the speed at **1 - Slowest** will result in the slowest refresh rate of the ‘block’ message, or slowest safe scrolling. **9 - Fastest** is the fastest speed, but many RDS radios display gibberish at high speed settings. The display should be stable with any radio at a speed setting of 7 or lower.

Parse Mode – sets the scroll step to be used in the “block” mode message transmission, more popular as ‘grouped-word’ method. Once Parse Mode option is set, this encoder function is valid for any scrolling-PS message, whether it is entered into the static DPS register, or received as ASCII text from station automation. Very short words are sent together in groups. For example, THIS IS constitutes seven characters that can be sent as a group. The same is applicable for OF THE or NOW HERE, also. Longer words, up to and including 8 characters, are sent individually: WARNING or DOUGHNUT or BICYCLE. The device can either center words that are sent individually on the radio display or left-justify them. This will be covered along with the function of the ‘DPS Scroll Step’. Words that exceed the available 8 characters are ‘sidestepped’ through two or more consecutive displays. Examples: EMERGENC followed by MERGENCY, or SUPERMAR followed by UPERMARK and PERMARKE and ERMARKET. This method of splitting words gives a good sense of continuity and readability. Setting Parse Mode to **1 - Scroll by 1 letter** will scroll the message one character at a time, as described. Other numbers also safe-scroll the message, but at 2, 3, 4, and up to 8 characters at a time. Selecting **9 - Left Justified** will parse, as described, but text will be left-justified rather than centered on the display. 2 through 8 may be useful in some special RDS applications, but 0 and 1 are the primary Parse Mode selections. To recap: **0 - Centered** will enable the more-popular, centered-auto-parsed block mode and **1 - Scroll by 1 letter** the Dynamic PS, letter-by-letter option.

Radio Text

RT Speed – The Radio Text update rate is programmed by setting RT Speed =n , with n a number between 1 and 9, corresponding to a refresh rate between slow and fast, respectively. Keeping the throughput tradeoff in mind, unless Radio Text is being used for contests or for other quasidynamic activities, it is best to use a lower number. A rate of 1, 2 or 3 will make little difference in the speed of other RDS functions.

Radio Text can be turned off entirely by setting: RT Speed=0. A zero value in this field turns the Radio Text message off, but does not delete any saved message from memory. The RT (Radio Text) is set in Basic RDS tab.

PTYN (Program Type Name) Settings

PTYN – Program Type Name is transmitted as 8-bit characters. PTYN must only be used to enhance Program Type information and it must not be used for sequential information.

PRTN Enable – [Enable] or [Disable] type 10A Group Transmission. This group allows further description of the current Program Type.

Date & Time Settings

CT Enable – [Enable] or [Disable] type 4A Group Transmission.

Console Settings

Server – [Enable] or [Disable] the RDS Console

Timeout – allows session timeout to be specified. Upon expiration of the time set the connection will be disabled.

TCP Port – a field where TCP port of the RDS console is to be entered. This console is used to edit RDS settings in real time. Default value is 2233.

Password – Password for the RDS console. These are the first symbols that must be sent to authenticate to the RDS console, otherwise the connection will be cancelled. If left blank NO security is used. Default value is blank (empty).

WHEN APPLYING NEW SETTINGS – In order new settings to take effect, it is necessary to press the [Save] button. Please keep in mind that some of the new settings can reset DB6400.

HOW TO CONNECT TO THE RDS CONSOLE

The RDS console is used to edit the RDS settings in real time. It can be used with an automation software or a terminal program.

To use the console, follow the steps listed below:

1. Connect to the TCP port of the RDS console with a terminal program or an automation software;
2. A welcome message HELLO will be received if proper connection is established;
3. If password is needed, the following message will appear PASS?;
4. Proceed with entering the commands.

RDS Console syntax

```
HELLO  
pass↵  
PASSOK  
PI=1234↵  
OK  
PI?↵  
1234  
OK  
TP=3↵  
NO
```

Depicted above is a sample RDS console conversation when a password is not set. The red text represents the user input and the black text - the console's responses. The ↵ symbol represent the Enter key on the keyboard.

- First row – is the welcome message from the RDS console. Next the user types in the password (in this case 'pass'), followed by Enter.
- Third row is the response meaning that the password is accepted and the user may proceed with commands.
- Fourth row is a 'set' command. These types of commands are used to set new value to RDS parameters. In the example above 'PI' is the Program Identification command, '=' (equal sign) means set new value and '1234' is the new value. The Enter key represents command's end and signals the RDS console to execute the command.
- Fifth row is a positive response from the RDS console. It means the command is accepted and executed successfully.
- Sixth row is a 'get' command. These types of commands are used to return the current value of RDS parameters. In the example above 'PI' is the Program Identification command, '?' (question mark) means return PI's value. The RDS console responds with the current value (in this case '1234') and positive response on the next row.
- Ninth row is again a 'set' command. In this case: Set Traffic Program to 3. The response is negative because the parameter TP can only have value 0 or 1.

List of available RDS console commands and their responses

PARAMETER	COMMAND	DATA ENTRY
INIT	INIT	Applies the default settings.
Program Identification	PI	4 digit HEX number (station "digital address")
Program Service	PS	8 (max) ASCII characters (station "street name")
Dynamic PS	DPS	64 (max) ASCII characters (for messaging in PS field)
Dynamic PS Speed	DPSS	0 to 9 (0 = Off, 1 = slow, 9 = fastest)
Dynamic PS Method	PARSE	0 through 9 (0 = parsed, centered; 1-8 = Safe Scrolling; 9 = parsed, left)
PTYN	PTYN	Sets Program Type Name
Program Type	PTY	1 or 2 digit number (describes station format)
Traffic Program	TP	0 or 1 (0 = no, 1 = yes)
Traffic Alert	TA	0 or 1 (0 = flag off, 1 = flag on)
Alternative frequencies	AF	0 to 204 (0 = blank; 1 to 204 = "channel" in 100 kHz increments, 87.6 MHz to 107.9 MHz)
Decoder Information	DI	1 digit HEX number
Music/Speech	MS	0 or 1 (0 = speech-only, 1 = music)
Radio Text	TEXT	64 (max) ASCII characters
Radio Text Speed	DRTS	0 to 9 (0 = RadioText off; 1 to 9 = update rate, slow to fast)
Command Echo	ECHO	0 or 1 (0 = echo off, 1 = echo on)
CT group 4A control	CTON	0 (disables) or 1 (enables) type 4A Group Transmission
PTYN group 10A control	PTYNON	0 (disables) or 1 (enables) type 10A Group Transmission
AF count	AFCOUNT	Sets the numbers of AFs transmitted.

SPECIAL COMMAND	MEANING
=	Set parameter value. Following a parameter command sets new value to that parameter; e.g.: PI=1234
?	Get parameter value. Following a parameter command returns status of encoder memory for that parameter; e.g.: AF3?
??	Returns all data in encoder memory.
INIT	Initializes the encoder to all factory defaults.

RESPONSE	MEANING
HELLO	Welcome message when connection to the console is established. If security is enabled proceed with entering the password. Otherwise proceed with commands.
PASS?	Password request. Will appear if such os set.
PASSOK	Password accepted, may proceed with commands.
PASSFAIL	Wrong password. Connection is dropped immediately
OK	Command received by encoder properly formatted and understood.
NO	Command properly formatted but data not understood.
BYE	Console has been inactive for more than 30 minutes and the connection will be dropped. User needs to connect again to enter more commands.
(NO RESPONSE)	Data sent is ignored by DB6400.

OUTPUT

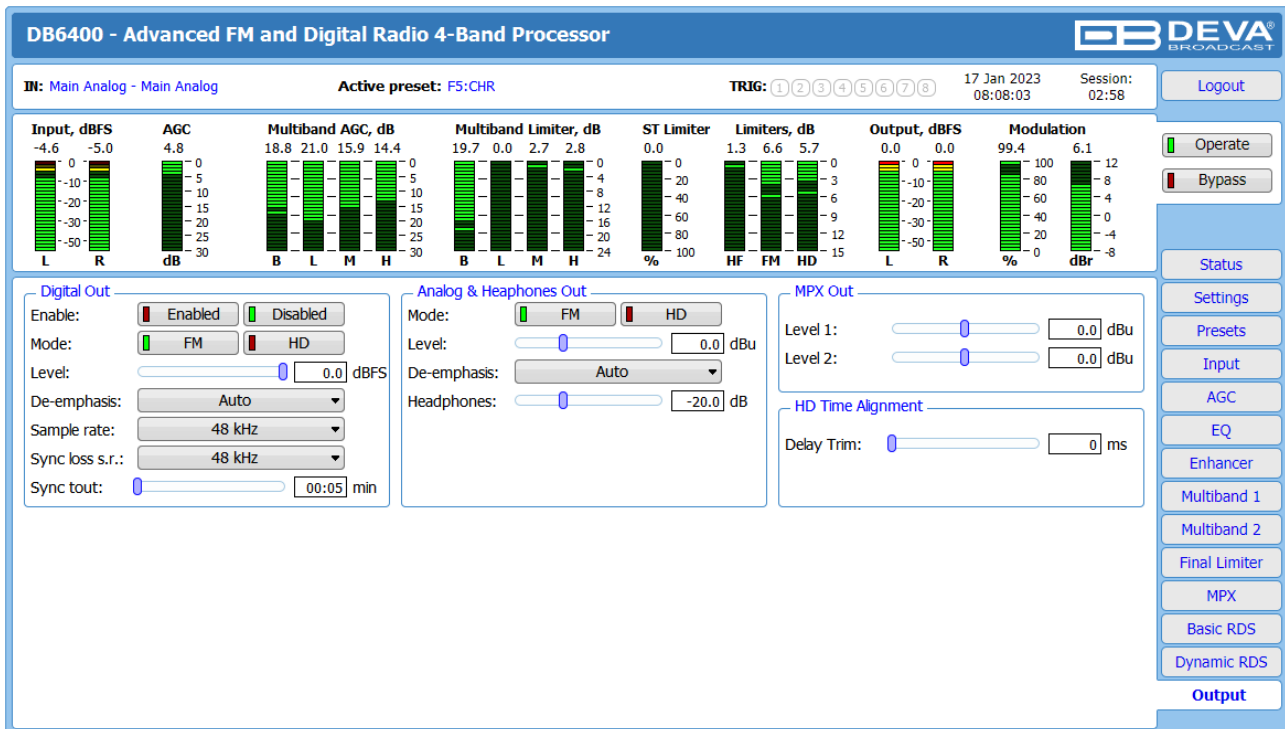

All the needed settings to the outputs can be applied through here. Each of the available outputs is separated in different sections.

Digital Output / Analog and Headphones Output – is intended to control the peak output level of the digital and analog output. A De-emphasis option is provided on both the analogue and digital outputs. The following control options are available – **FLAT** (off), **50µs** (for Europe) and **75µs** (for USA). If the selected De-emphasis option is Auto, the De-emphasis is automatically set to the same value as the Pre-emphasis (Flat, 50µs for Europe or 75µs for USA). However, if you aim at hearing how the Pre-emphasis affects the audio, the OFF De-emphasis option should be chosen.

IMPORTANT NOTE: If you plan to feed audio codecs with de-emphasised analog audio, we recommend that you use HD audio path.

The **Digital Output** should be internally or externally synchronized in order to be functioning correctly. This is specified by the Sample rate setting. If the synchronization should be made internally, a value from the standard range of **32 to 192 kHz** should be chosen. If the synchronization method is external, the relevant option should be selected from the drop-down menu. When External synchronization is chosen, **Sync loss s.r.** and **Sync tout** should be set in order for possible loss of the audio at the digital output to be prevented. If such is present, the DB6400 will switch to internal synchronization (the value being specified in **Sync loss s.r.**) after the defined **Sync Timeout** expires.

MPX Out Level should match the one of the transmitter (or link device if one is used).

HD Time Alignment – Because of the time delay in the digital portion of the HD Radio audio path, the analog and digital signals are supposed to be time-aligned. When the alignment is correct, the transitional blend from analog to digital or vice-versa will be almost transparent. When setting this parameter, have in mind that a time-alignment error of 1 millisecond will cause spectral notches during transition which will be audible by the listeners.

IT IS RECOMMENDED when the HD time Alignment is not used, the slider (value) to be set to **0 ms** as by default. Otherwise the result will be undesired audio delay.

APPENDIX A

RDS: EUROPE VS AMERICA

The European Broadcasting Union (EBU) and its member countries originated the concept of “Radio Data” transmission. The European RDS specification, CENELEC Standard EN50067, was first published in 1984. It was revised in 1986, 1990, 1991 and 1992.

European RDS has grown in use following initial adoption of the Standard. RDS is nearly universal throughout Europe; it is almost impossible to find a European FM broadcasting station that does not carry a radio data subcarrier.

The popularity of RDS in Europe is very much in contrast with initial reluctance on the part of US broadcasters to embrace this technology. This can be ascribed to material differences in broadcasting practices.

Almost without exception, FM broadcasting in the United States is ‘detached’ and independent - each station originates its own programming. America’s National Public Radio might be considered as an exception, though for most of the broadcast day even NPR stations originate, or at least schedule, their own programs.

Most of European broadcasting is similar to the concept of network radio that was common in the US prior to the 1950s. In Europe, a central program originator may have many transmitting facilities of modest power situated throughout the country, at several different frequencies to blanket a designated service area. The European disposition, toward lower-power transmitters can be found on the “local radio” level, as well.

The European concept of a service area equates to the US broadcaster’s market. The subtle difference between these designations further characterizes broadcasting practices and ethics. RDS benefits the European broadcaster through almost an altruistic endeavor to be of service to his listeners. The US broadcaster is marketing his programming and is primarily interested in how he can create additional revenue from RDS.

THE RDS SYSTEM

RDS is a digital data channel, transmitted as a low-level subcarrier above the range of the composite stereo program signal in the FM baseband. The data transmission (baud) rate is comparatively low, yet it is quite robust because of data redundancy and effective error correction.

It is not within the scope of this Manual to cover the details of RDS subcarrier coding and modulation. For this, the reader is directed to the Specification appropriate to his location either the CENELEC EN50067 Specification for Europe or the United States NRSC Specification. Since the Manual will deal with specific implication of RDS implemented with the DB6400, it is assumed that the user is familiar with the RDS concept.

APPENDIX B.1

PTY Code Description Used in RBDS Mode – North America

PTY	Short Name	Description
1	News	News reports, either local or network in origin.
2	Information	Programming that is intended to impart advice.
3	Sports	Sports reporting, commentary, and/or live event coverage, either local or network in origin.
4	Talk	Call-in and/or interview talk shows either local or national in origin.
5	Rock	Album cuts.
6	Classic Rock	Rock oriented oldies, often mixed with hit oldies, from a decade or more ago.
7	Adult Hits	An up-tempo contemporary hits format with no hard rock and no rap.
8	Soft Rock	Album cuts with a generally soft tempo.
9	Top 40	Current hits, often encompassing a variety of rock styles.
10	Country	Country music, including contemporary and traditional styles.
11	Oldies	Popular music, usually rock, with 80% or greater non-current music.
12	Soft	A cross between adult hits and classical, primarily non-current softrock originals.
13	Nostalgia	Big-band music.
14	Jazz	Mostly instrumental, includes both traditional jazz and more modern “smooth jazz.”
15	Classical	Mostly instrumentals, usually orchestral or symphonic music.
16	Rhythm and Blues	A wide range of musical styles, often called “urban contemporary.”
17	Soft R and B	Rhythm and blues with a generally soft tempo.
18	Foreign Language	Any programming format in a language other than English.
19	Religious Music	Music programming with religious lyrics.
20	Religious Talk	Call-in shows, interview programs, etc. with a religious theme.
21	Personality	A radio show where the on-air personality is the main attraction.
22	Public	Programming that is supported by listeners and/or corporate sponsors instead of advertising.
23	College	Programming produced by a college or university radio station.
24	Spanish Talk	Call-in shows, interview programs, etc. in the Spanish language
25	Spanish Music	Music programming in the Spanish language
26	Hip-Hop	Popular music incorporating elements of rap, rhythm-and-blues, funk, and soul
27-28	Unassigned	
29	Weather	Weather forecasts or bulletins that are non-emergency in nature.
30	Emergency Test	Broadcast when testing emergency broadcast equipment or receivers. Not intended for searching or dynamic switching for consumer receivers. Receivers may, if desired, display “TEST” or “Emergency Test”.
31	Emergency	Emergency announcement made under exceptional circumstances to give warning of events causing danger of a general nature. Not to be used for searching - only used in a receiver for dynamic switching.

NOTE: These definitions can differ slightly between various language versions.

APPENDIX B.2

PTY Code Description Used in RDS Mode – Europe, Asia

PTY	Short Name	Description
1	News	Short accounts of facts, events and publicly expressed views, reportage and actuality.
2	Current affairs	Topical program expanding or enlarging upon the news, generally in different presentation style or concept, including debate, or analysis.
3	Information	Program the purpose of which is to impart advice in the widest sense.
4	Sport	Program concerned with any aspect of sport.
5	Education	Program intended primarily to educate, of which the formal element is fundamental.
6	Drama	All radio plays and serials.
7	Culture	Programs concerned with any aspect of national or regional culture.
8	Science	Programs about the natural sciences and technology.
9	Varied	Used for mainly speech-based programs usually of light-entertainment nature, not covered by other categories. Examples include: quizzes, games, personality interviews.
10	Pop	Commercial music, which would generally be considered to be of current popular appeal, often featuring in current or recent record sales charts.
11	Rock	Contemporary modern music, usually written and performed by young musicians.
12	Easy Listening	Current contemporary music considered to be “easy-listening”, as opposed to Pop, Rock or Classical, or one of the specialized music styles, Jazz, Folk or Country. Music in this category is often but not always, vocal, and usually of short duration.
13	Light classics	Classical Musical for general, rather than specialist appreciation. Examples of music in this category are instrumental music, and vocal or choral works.
14	Serious classics	Performances of major orchestral works, symphonies, chamber music etc., and including Grand Opera.
15	Other music	Musical styles not fitting into any of the other categories. Particularly used for specialist music of which Rhythm & Blues and Reggae are examples.
16	Weather	Weather reports and forecasts and Meteorological information.
17	Finance	Stock Market reports, commerce, trading etc.
18	Children’s programs	For programs targeted at a young audience, primarily for entertainment and interest, rather than where the objective is to educate.
19	Social Affairs	Programs about people and things that influence them individually or in groups. Includes: sociology, history, geography, psychology and society.
20	Religion	Any aspect of beliefs and faiths, involving a God or Gods, the nature of existence and ethics.
21	Phone In	Involving members of the public expressing their views either by phone or at a public forum.
22	Travel	Features and programs concerned with travel to near and far destinations, package tours and travel ideas and opportunities. Not for use for Announcements about problems, delays, or roadworks affecting immediate travel where TP/TA should be used.
23	Leisure	Programs concerned with recreational activities in which the listener might participate. Examples include, Gardening, Fishing, Antique collecting, Cooking, Food & Wine etc.
24	Jazz Music	Polyphonic, syncopated music characterized by improvisation.
25	Country Music	Songs which originate from, or continue the musical tradition of the American Southern States. Characterized by a straightforward melody and narrative story line.
26	National Music	Current Popular Music of the Nation or Region in that country’s language, as opposed to International ‘Pop’ which is usually US or UK inspired and in English.
27	Oldies Music	Music from the so-called “golden age” of popular music.
28	Folk Music	Music which has its roots in the musical culture of a particular nation, usually played on acoustic instruments. The narrative or story may be based on historical events or people.
29	Documentary	Program concerned with factual matters, presented in an investigative style.
30	Alarm Test	Broadcast when testing emergency broadcast equipment or receivers. Not intended for searching or dynamic switching for consumer receivers.. Receivers may, if desired, display “TEST” or “Alarm Test”.
31	Alarm	Emergency announcement made under exceptional circumstances to give warning of events causing danger of a general nature. Not to be used for searching - only used in a receiver for dynamic switching.

APPENDIX C

HOW SHOULD I CONFIGURE THE CONNECTION BETWEEN MY DEVA DEVICE AND AN FTP CLIENT?

In order for a connection to be established the following setting should be applied:

1. FTP Server Settings

The built-in FTP Server has four important parameters that should be configured: Command Port, Data Port, User name and Password. These parameters are to be used in the FTP client's connection configuration. Further information on how to change the FTP Server's settings and their respective default values can be found in the device's User manual.

WE RECOMMEND the usage of FileZilla (<https://filezilla-project.org>). This is a widespread open source software distributed free of charge, hence available for downloading from the Internet.

NOTE: The FTP Server can manage only one connection at a time. The FTP Server works in Passive mode. Hence, the FTP Client should also be set in passive mode.

2. IP Router and Port Translation Settings

If the connection to the device is made through a Network address translation (NAT) router or firewall, the port forwarding feature of the router should be configured. The port forwarding is usually set in the firewall section of the router's menu. As each router has different port forwarding procedure, we recommend you to refer to its complete manual. To allow proper data flow through the router, the FTP Command and FTP Data ports should be open.

NOTE: The FTP port numbers to be used in the port forwarding feature configuration can be found in the device.

3. Example of FTP Client (FileZilla) Settings

In some cases, FileZilla's "Quick connect" feature is not able to connect with the DEVA unit. That is why we recommend the device to be assigned in the program manually.

Enter the FTP Client and go to: **File > Site manager > New Site**. A dialog box requiring obligatory information about the device will appear. Fill in the needed information and press "OK".

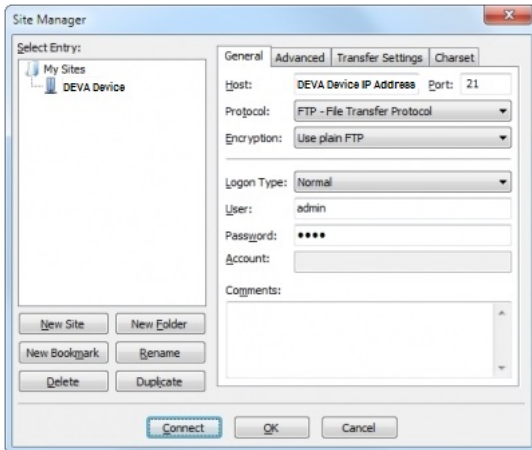

Select "Transfer Settings" sub-menu and apply the settings as shown below:

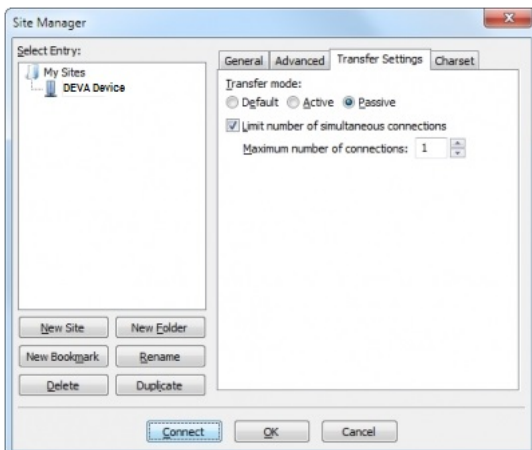

WARRANTY TERMS AND CONDITIONS

I. TERMS OF SALE: DEVA Broadcast Ltd. products are sold with an understanding of “full satisfaction”; that is, full credit or refund will be issued for products sold as new if returned to the point of purchase within 30 days following their receipt, provided that they are returned complete and in an “as received” condition.

II. CONDITIONS OF WARRANTY: The following terms apply unless amended in writing by DEVA Broadcast Ltd.

A. The Warranty Registration Card must be completed and returned to DEVA Broadcast Ltd. within 10 days of delivery. Product registration can also be done digitally at <https://www.devabroadcast.com/members/product-registration>, after registering on our website, within 10 days of delivery.

B. This Warranty applies only to products sold “as new.” It is extended only to the original end-user and may not be transferred or assigned without prior written approval by DEVA Broadcast Ltd.

C. This Warranty does not apply to damage caused by improper mains settings and/or power supply.

D. This Warranty does not apply to damage caused by misuse, abuse, accident or neglect. This Warranty is voided by unauthorized attempts at repair or modification, or if the serial identification label has been removed or altered.

III. TERMS OF WARRANTY: DEVA Broadcast Ltd. products are warranted to be free from defects in materials and workmanship.

A. Any discrepancies noted within TWO YEARS of the date of purchase will be repaired free of charge, or the equipment will be replaced with a new or remanufactured product at DEVA Broadcast Ltd. option.

B. Parts and labor for factory repair required after the two-year Warranty period will be billed at prevailing prices and rates.

IV. RETURNING GOODS FOR FACTORY REPAIR:

A. Equipment will not be accepted for Warranty or other repair without a Return Material Authorization (RMA) number issued by DEVA Broadcast Ltd. prior to its return. An RMA number may be obtained by placing an RMA request at <https://www.devabroadcast.com/rma>. The number should be prominently marked on the outside of the shipping carton.

B. Equipment must be shipped prepaid to DEVA Broadcast Ltd. Damage sustained as a result of improper packing for return to the factory is not covered under terms of the Warranty and may occasion additional charges.

V. UPDATES TO THE TERMS OF SERVICE:

For the most up-to-date, valid, and accurate terms, conditions, and product documentation, please visit the official DEVA Broadcast Ltd. website downloads section at <https://www.devabroadcast.com/downloads/deva-documents>. Printed documents may not reflect recent amendments. Reviewing the current online versions ensures you have the latest information.



PRODUCT REGISTRATION CARD

- All fields are required, or warranty registration is invalid and void

Your Company Name _____

Contact _____

Address Line 1 _____

Address Line 2 _____

City _____

State/Province _____ ZIP/Postal Code _____

Country _____

E-mail _____ Phone _____ Fax _____

Which DEVA Broadcast Ltd. product did you purchase? _____

Product Serial # _____

Purchase date ____ / ____ / ____

Installation date ____ / ____ / ____

Your signature*

*Signing this warranty registration form you are stating that all the information provided to DEVA Broadcast Ltd. are truth and correct. DEVA Broadcast Ltd. declines any responsibility for the provided information that could result in an immediate loss of warranty for the above specified product(s).

Privacy statement: DEVA Broadcast Ltd. will not share the personal information you provide on this card with any other parties.